



# FALL PROTECTION SYSTEMS AND PROTECTIVE EQUIPMENT

SAFETY, FOR INDUSTRY AND CONSTRUCTION

**rothoblaas**

Solutions for Safety

# LIFELINE AND RAIL SYSTEMS

17

# ANCHOR POINTS

95

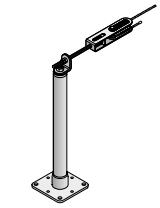

PATROL + TOWER ..... 22  
 PATROL + TOWER A2 ..... 24  
 PATROL + TOWER XL ..... 26

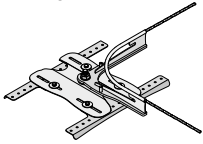

PATROL + SHIELD | SHIELD 2 ..... 28

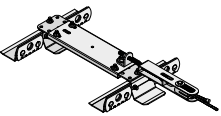

PATROL + SIANK 4 | SIANKINT ..... 30

PATROL + SEAMO ..... 32  
 PATROL + COPPO ..... 34  
 PATROL + TWIST ..... 36

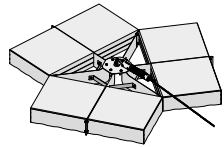

PATROL + BLOCK ..... 38

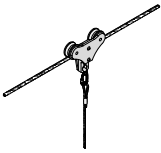

PATROL + PATROLEND ..... 40  
 PATROL OVERHEAD ..... 42  
 PATROL ON WALL ..... 44  
 PATROL A4 ..... 46

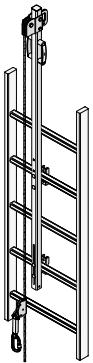

VERTIGRIP ON LADDER ..... 56  
 VERTIGRIP ON WALL ..... 58  
 VERTIGRIP A4 ..... 60

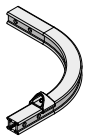

H-RAIL ON FLOOR ..... 72  
 H-RAIL + TOWER ..... 74  
 H-RAIL OVERHEAD ..... 76  
 H-RAIL ON WALL ..... 78

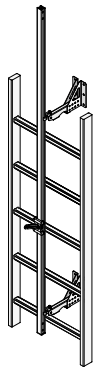

V-RAIL ..... 82

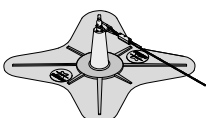

GREEN LINE ..... 86  
 TEMPORARY ..... 90  
 HOLD-SYSTEM® ..... 91



WING ..... 98

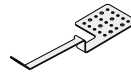

HOOK EVO ..... 100  
 HOOK EVO 2.0 ..... 101

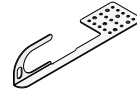

HOOK SPIKE ..... 102



LOOP ..... 104

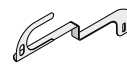

SLIM ..... 105



KITE ..... 106



AOS ..... 108

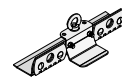

SIANK ..... 110

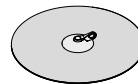

GREEN POINT ..... 111

GLUE ANCHOR ..... 112

WING 2 ..... 114

MOBILE ..... 114

ROD ..... 115

CARRIER ..... 115

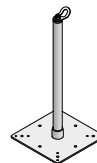

AOS01 + TOWER/TOWER A2 ..... 118

AOS01 + TOWER XL ..... 120

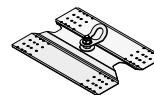

AOS01 + SHIELD ..... 122

AOS01 + SHIELD 2 ..... 123

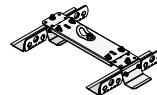

AOS01 + SIANK 4 ..... 124

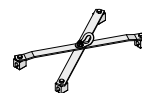

AOS01 + SEAMO ..... 125

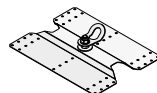

AOS01 + COPPO ..... 126

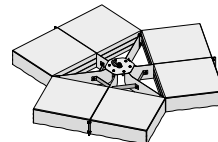

AOS01 + BLOCK ..... 127

# COLLECTIVE PROTECTION

131

# PERSONAL PROTECTIVE EQUIPMENT

169

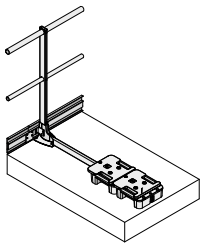

GUARD .....134  
 GUARD H .....136  
 GUARD V/GUARD VD.....137  
 GUARD W.....138  
 GUARD Z.....139  
 GUARD M.....140

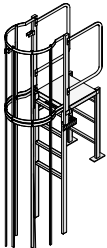

LADSTEP .....144

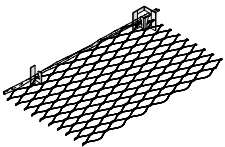

SAFENET .....150  
 ROLLNET .....152

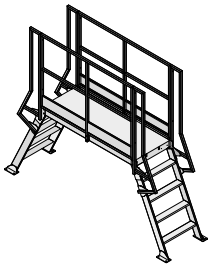

WALKSAFE .....154  
 OVERLANE.....156

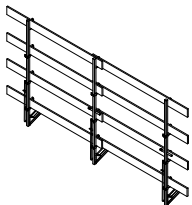

EDGE TEMP 1.....158  
 EDGE TEMP 2.....158  
 EDGE TEMP 3.....159  
 EDGE TEMP 4 .....159

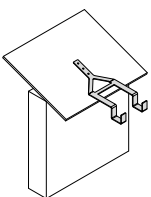

HANG TEMP.....160  
 HANG ROOF .....160  
 HANG WALL.....161  
 HANG PLAIN.....161

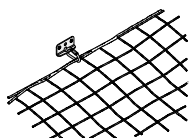

HORIZONTAL NET.....162  
 VERTICAL NET.....164  
 FRAME NET .....165

# COMPLEMENTARY PRODUCTS

227

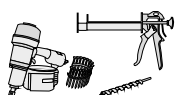

ACCESSORIES.....228  
 FASTENERS.....234  
 TOOLS.....248

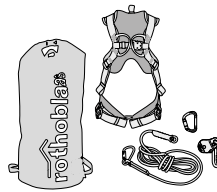

KITS .....172



HELMETS .....186



HARNESSES.....190

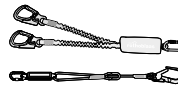

FALL PROTECTION AND POSITIONING.....198

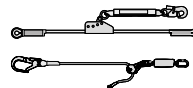

ROPES AND ACCESSORIES.....200



RETRACTABLE DEVICES .....203

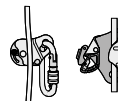

SELF-LOCKING DESCENDERS .....204

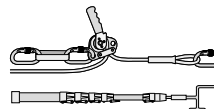

DESCENDERS-POSITIONING.....206



ANCHOR SYSTEMS .....208



CONNECTORS.....210



PULLEYS.....212



ACCESSORIES.....213



TRIPODS AND CRANES.....216

# CONTENTS

# IN THE SERVICE OF SECURITY



## IN-HOUSE PRODUCT DEVELOPMENT AND TESTING

When developing a new product, we directly follow all stages: market analysis, feasibility studies, planning and design, functional and effectiveness tests, including tests on fixings and substrates. All tests are carried out using the replication of a real roof.

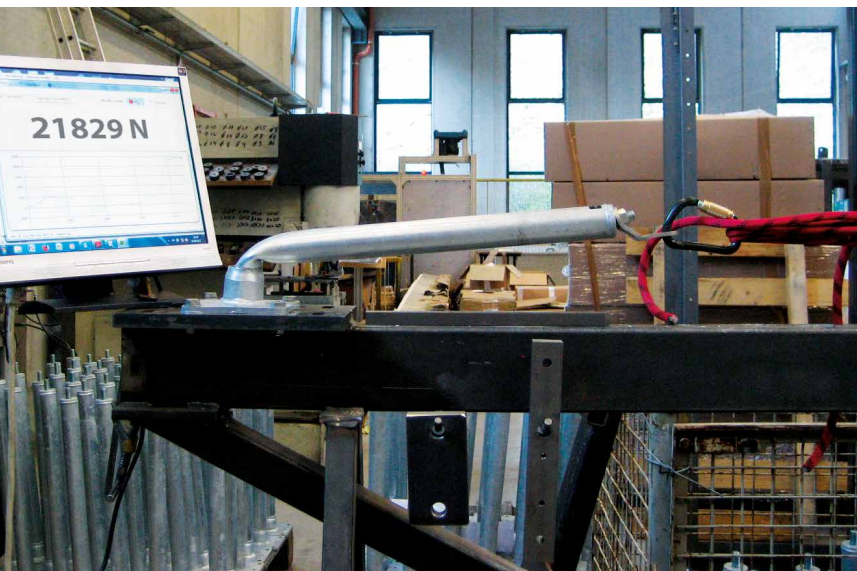

## EXTERNAL CERTIFICATION

In the certification process of our products, we are followed by an external certification body. The tests are carried out on the different types of substructure according to current technical standards, which include deformation tests, dynamic tests, static tests, failure tests and corrosion tests. The certification also takes into account the technical documentation, which must be drawn up according to certain characteristics.

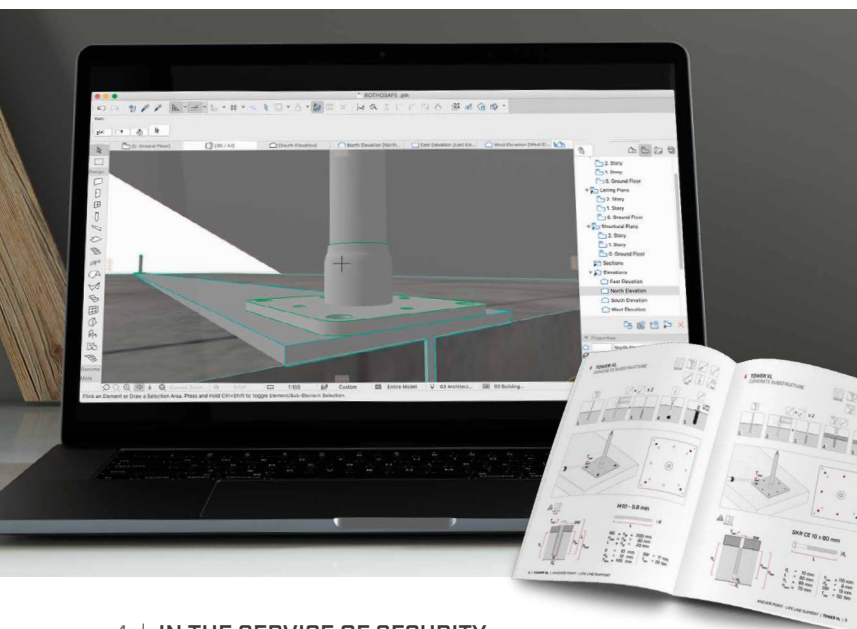

## ONLINE DOCUMENTATION

On our website you will find all the documentation relating to our products, in various languages: installation and user manuals, technical data sheets, certificates, BIM/CAD objects, assembly videos, software for calculating and verifying lifelines and support for the correct preparation of an estimate. Our safety solutions are designed together with the substructure fixings and waterproofing systems, so that we can guarantee professional installation.

# WHO USES OUR PRODUCTS?

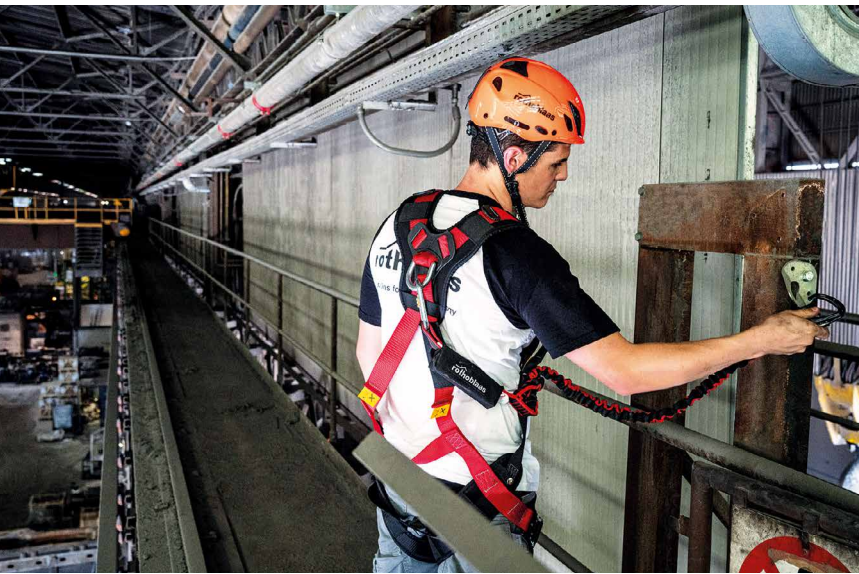

## INTEGRATED SOLUTIONS FOR INDUSTRY

Our product range is constantly being updated in order to meet the constant demands of the market. Whether you are involved in industrial safety, specialised distribution of fall protection systems, renewable energy or plant safety, you will find the right solution for you.



## SYSTEMS AND PRODUCTS FOR SITE SAFETY

Our products are ideal for ensuring safety at work for builders of timber houses and large glulam and CLT structures, carpenters, tinsmiths and building renovation professionals.



## RESALE-FRIENDLY DISPLAY

Do you have an exhibition space? We provide you with the tools to present your products in the best possible way in your building materials shop, hardware shop or retail outlet. Metal displays, communication tools and gadgets for your customers will help you maximise your business.

# COMPLETE RANGE

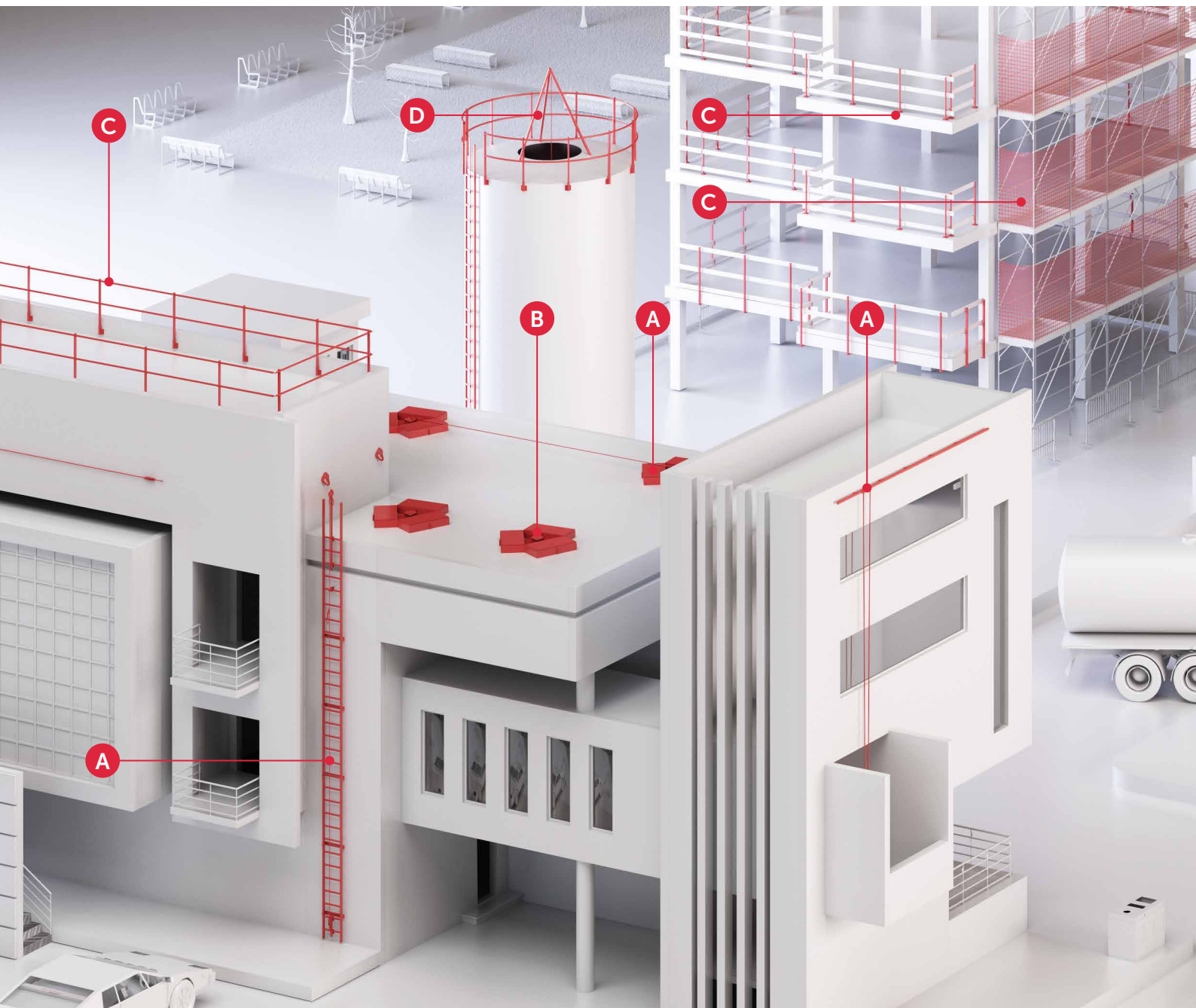

## A LIFELINE AND RAIL SYSTEMS

Our lifeline systems meet every design requirement: rope or rail, fixed or temporary, horizontal or vertical.

They are convenient systems for the operators: they allow easier movement than single points, are comfortable in use thanks to the through systems and offer the possibility of securing up to 4 operators at the same time.

## B ANCHOR POINTS

Anchor points are the alternative or complement to lifelines. Those in the Rothoblaas Solutions for Safety range are designed to meet different construction requirements and to adapt to substrates made of various materials.

Designed for use with different techniques (anti-fall, restraint, suspension), they allow direct connection with the PPE, offering safety to a number of operators that can vary from 1 to 4 depending on the type of device.

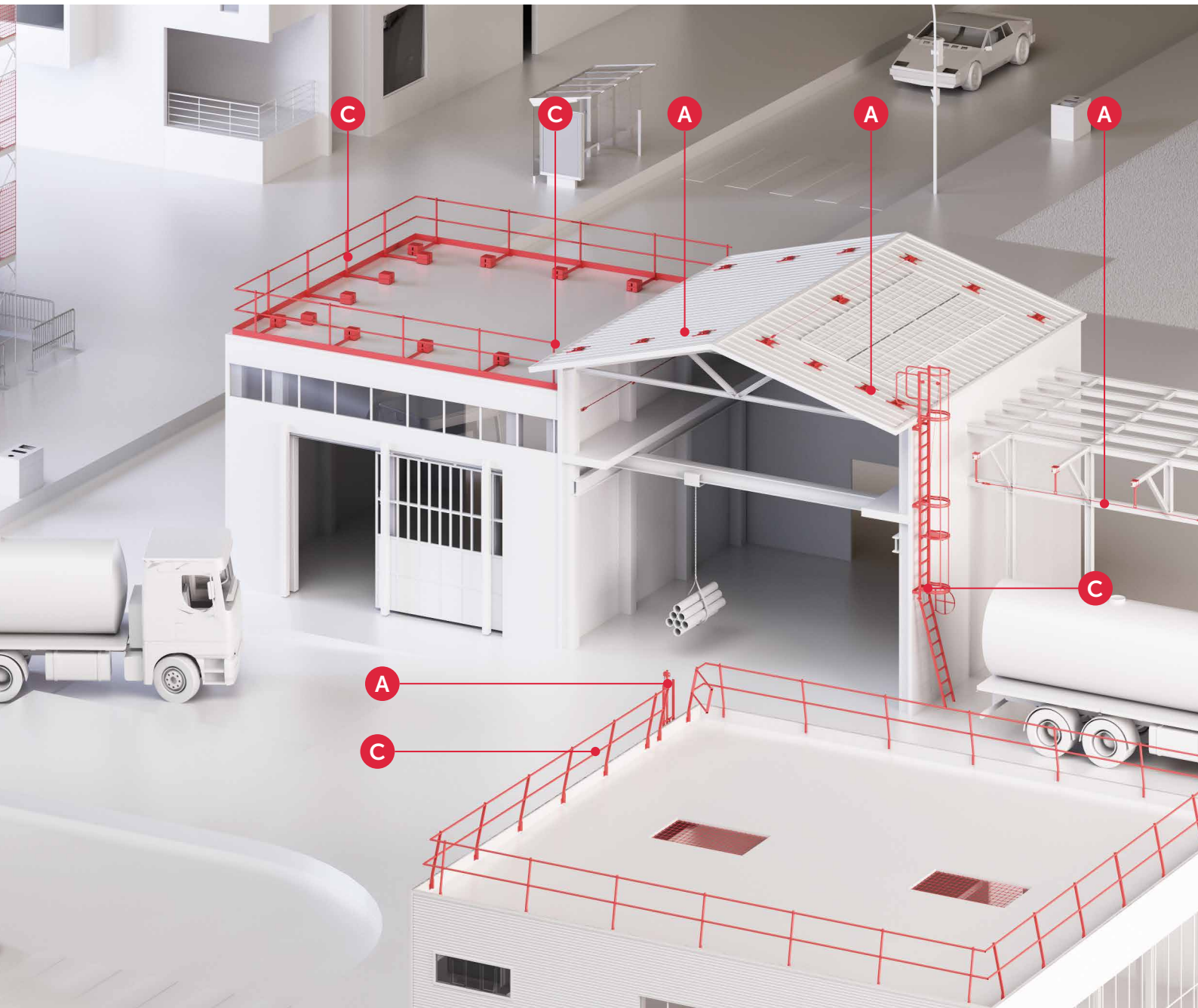

## **C** COLLECTIVE PROTECTION

Collective Protective Equipment (CPE) include all temporary or permanent devices designed to protect more than one operator from the risk of falling. These include, for example, railings, textile and metal nets, ladders with and without cages, steps and other types of protection.

Thanks to the CPE it is possible to work safely even without PPE.

## **D** PERSONAL PROTECTIVE EQUIPMENT

Personal Protective Equipment (PPE) includes any type of equipment designed to be worn or used by the workers in order to protect them from risks that could threaten their safety while carrying out operations at height.

# ONLINE RESOURCES

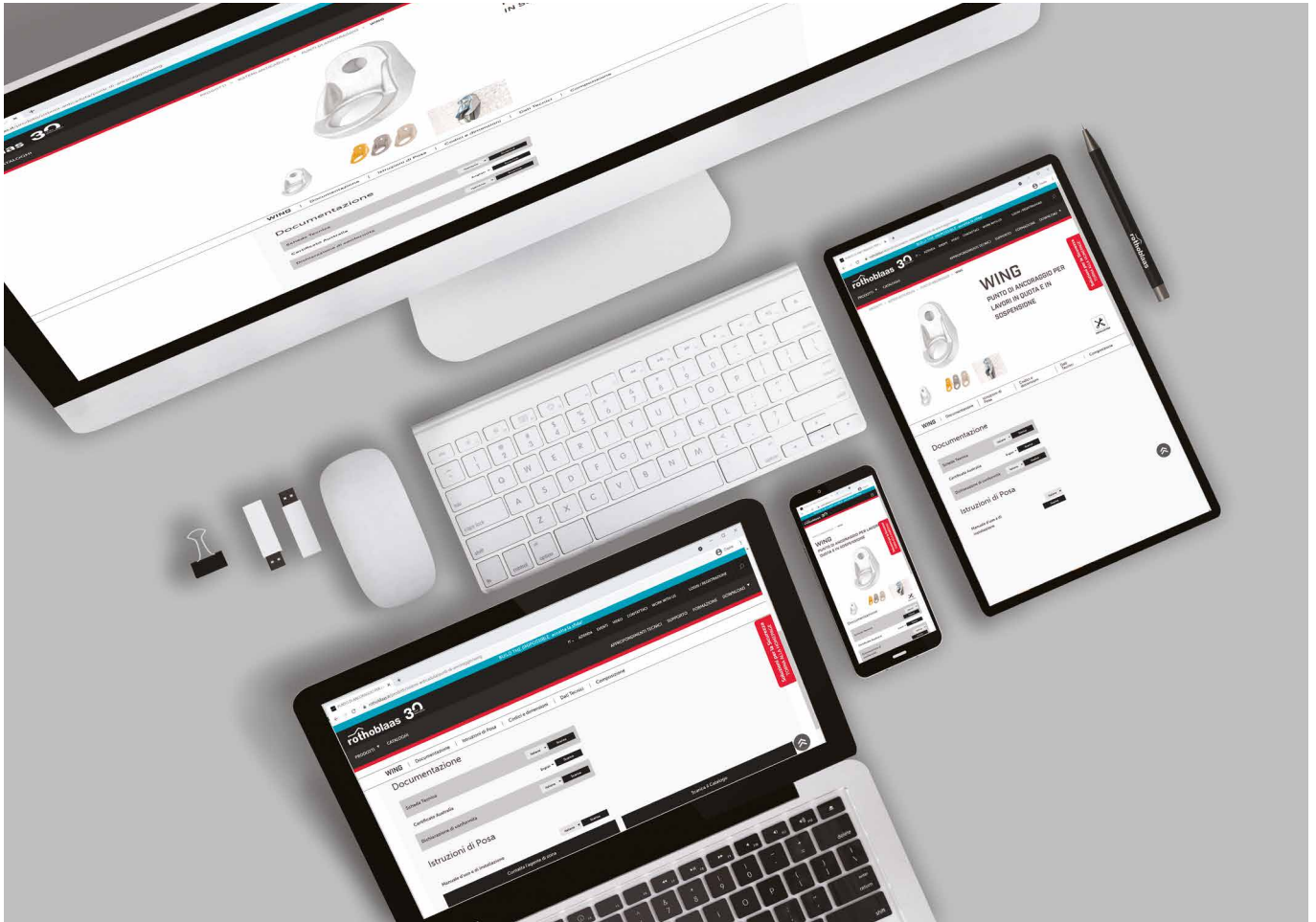

## COMPLETE MULTILINGUAL DOCUMENTATION





On our website we provide documentation and tools to simplify your work. The documents are easily accessible, either by scanning the QR codes you find in the catalogue next to the products, or through the advanced search function on the site, **using the appropriate filters**.

Among the available documentation you will find:

- catalogue
- technical data sheets
- installation manuals and safety regulations
- certificates
- declaration of conformity
- technical data

To support your planning, you will also find on our website:

- BIM and CAD objects
- calculation software for lifeline
- video available on our YouTube channel

FILTER	RESET
<b>MATERIAL</b>	
<input type="checkbox"/>	zinc-plated steel
<input checked="" type="checkbox"/>	stainless steel
<input type="checkbox"/>	A2 stainless steel
<input type="checkbox"/>	A4 stainless steel
<input type="checkbox"/>	aluminium alloy
<input type="checkbox"/>	plastic materials
<b>NUMBER OF USERS</b>	
<input type="checkbox"/>	
<input type="checkbox"/>	
<input type="checkbox"/>	
<input type="checkbox"/>	
<b>SUBSTRUCTURES</b>	
<input type="checkbox"/>	timber
<input type="checkbox"/>	concrete
<input type="checkbox"/>	steel
<input type="checkbox"/>	metal sheet/panel
<input type="checkbox"/>	continuous metal roof
<input type="checkbox"/>	fixed ladder
<input type="checkbox"/>	PVC
<input type="checkbox"/>	bituminous
<input type="checkbox"/>	green/gravel flat roof



# PRODUCT

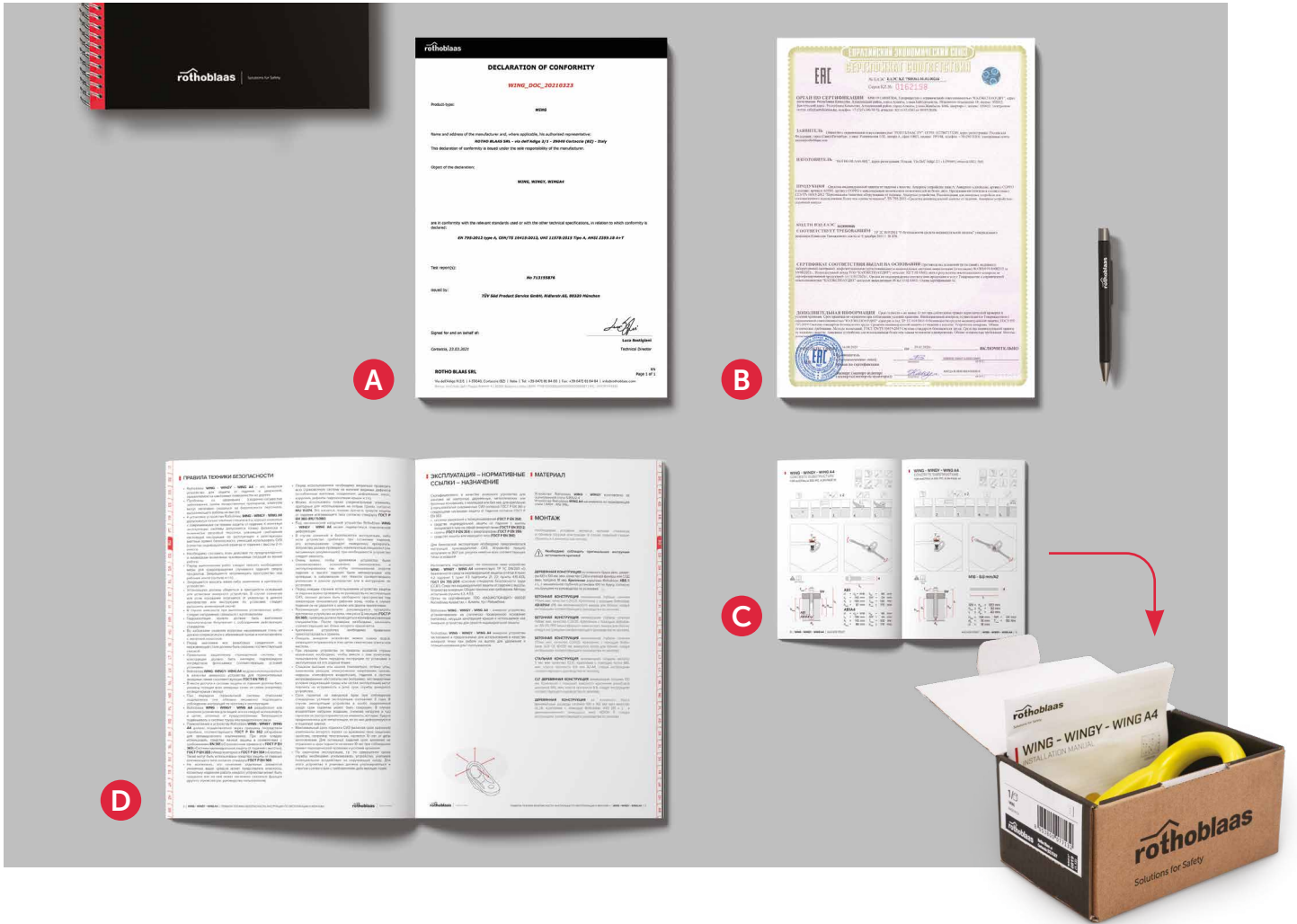

**A** DECLARATION OF CONFORMITY

**C** INSTALLATION MANUAL

**B** CERTIFICATE

**D** SAFETY REGULATIONS

## CERTIFIED PRODUCTS

Our products are tested in the presence of certification bodies that validate the tests performed and certify them according to the relevant standards.

The marking contains normative references, product traceability and information for correct use.

The documentation for the devices (declarations of conformity, certificates, installation manuals and safety regulations) are available on our web site [www.rothoblaas.com](http://www.rothoblaas.com), easily traceable thanks to the QR codes found inside this catalogue.

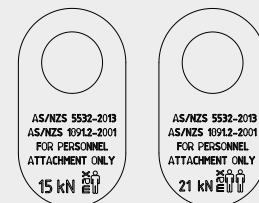
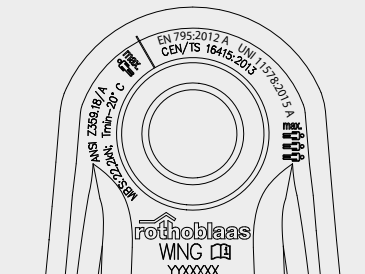

# TECHNIQUES FOR WORK AT HEIGHT

## POSITIONING

Working technique that allows the operator to work under tension with its devices, hands free:

- in the case where the risk of falling into the void is null: positioning harness and positioning lanyard.
- if there is a risk of falling (uncovered roof, roof not protected by collective protection, steep slope, etc.): positioning and fall protection harness, positioning lanyard, fall arrest system.

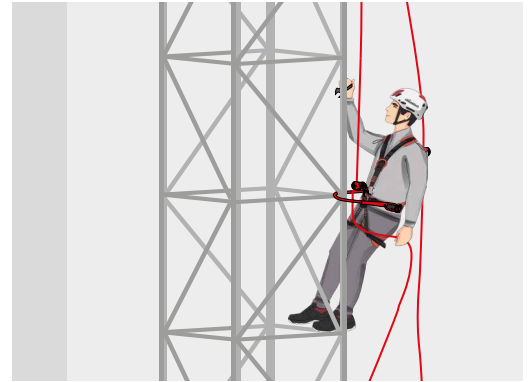

## RESTRAINT

Work with restraint involve a system that limits worker movement to prevent them reaching areas in which a fall from height could occur. This system does not arrest a fall from height, but instead prevents it.

**This system is generally preferable compared to working with a fall protection system.**



## FALL PROTECTION

The fall arrest system has the purpose of:

- reducing the distance required to arrest a fall;
- absorbing the energy of the fall to limit the arresting force transmitted to the human body;
- keeping the injured in an appropriate position to limit the effects of inert suspension.

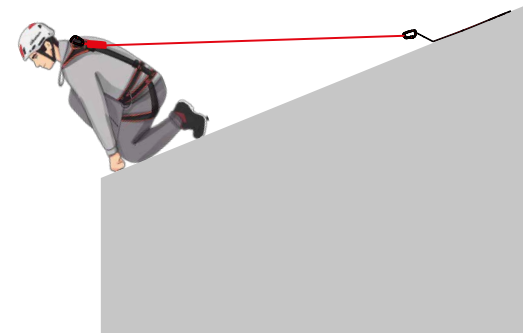

## RISKS: PENDULUM EFFECT

The "pendulum effect" refers to a lateral movement that occurs after a fall when the anchor is not located vertically with respect to the worker. This situation can be dangerous, as it can cause the worker to collide with an obstacle located along the fall trajectory.

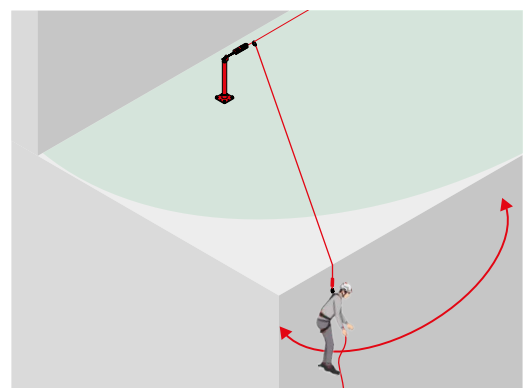

# PRINCIPLES OF WORK AT HEIGHT

## VERTICAL CLEARANCE

When working in fall protection, the **VERTICAL CLEARANCE** must be taken into account:

$$TA = LC + L_{max} + HA + D_{SIC} (+ f) \quad [m]$$

- TA** vertical clearance
- LC** length of the rope from the fixed anchoring point to the roof to the anchoring point of the harness at the moment the rope begins to stop the fall
- L<sub>max</sub>** maximum extension of the energy absorber (maximum 1,75 m)
- HA** 1,50 m average height above the operator's feet from the sternal/ dorsal anchor point of the harness
- D<sub>SIC</sub>** safety distance (minimum 1 m)
- f** possible deformation of the system caused by a fall

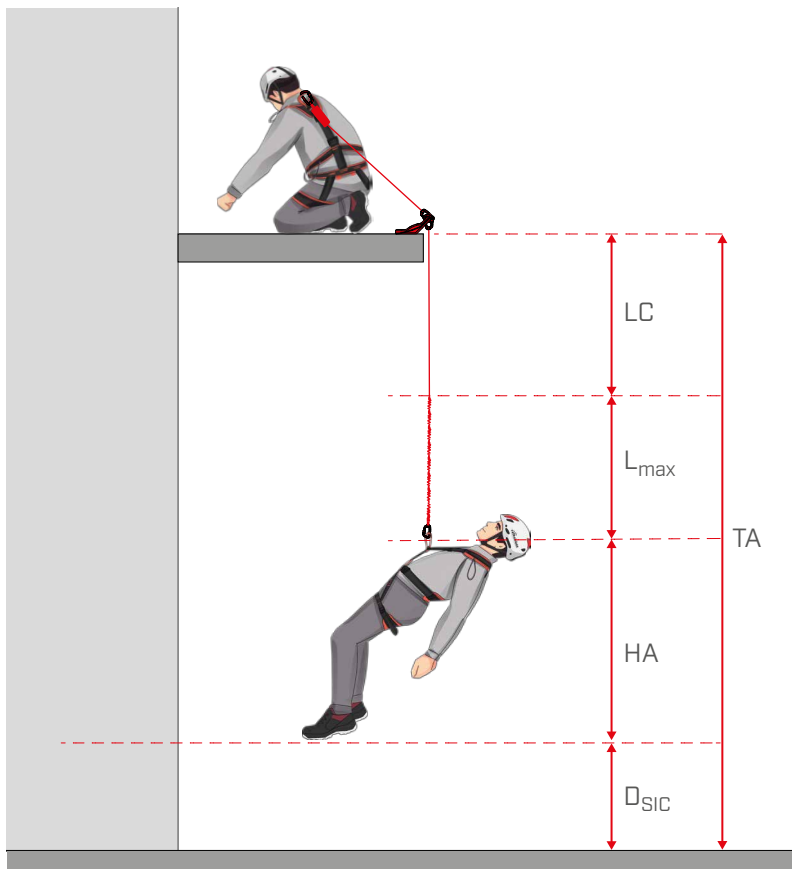

## FALL FACTOR

The **FALL FACTOR** expresses the degree of danger of a fall:

$$F_C = H / L$$

- F<sub>C</sub>** fall factor
- H** height fallen during the fall
- L** length of the rope / connection device

The value obtained from the equation must be between 0 and 2, with 2 representing the maximum fall factor.

The lower the value of the fall factor, the less stress will be placed on the operator's body. On the other hand, a high fall factor can result in high decelerations that are difficult for a human body to withstand and cause serious injuries to the operator.

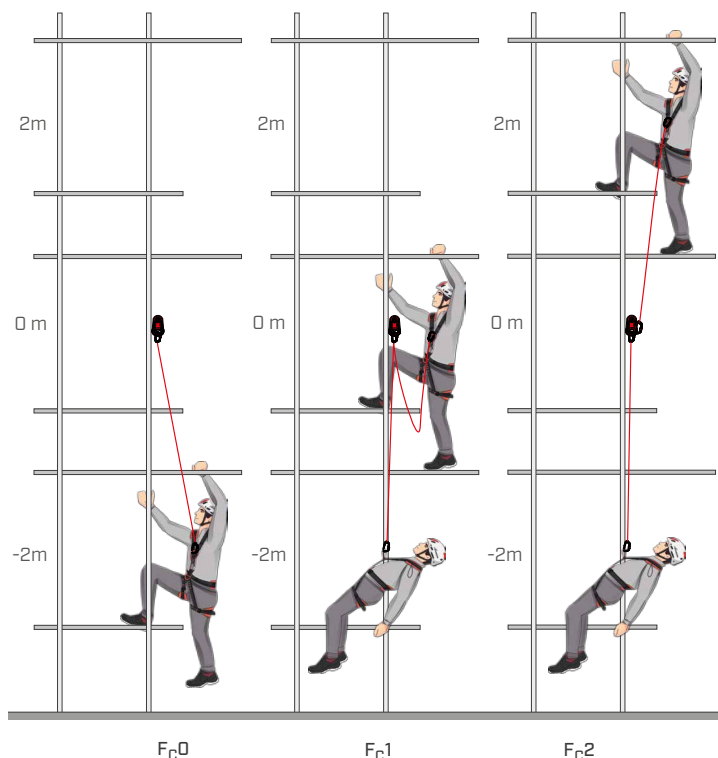

	F <sub>C0</sub>	F <sub>C1</sub>	F <sub>C2</sub>
without energy absorber	✓	!	✗
with energy absorber	✓	✓	!

# STANDARDS

## OVERVIEW OF REGULATIONS ON LIFELINES, RAILS AND ANCHOR POINTS

### PATROL + SHIELD



EAC

EN  
795:2012 C

CEN/TS  
16415:2013  

UNI  
11578:2015  
C  

AS/NZS  
1891.2:2001  

AS/NZS  
1891.4:2009

### AOS01 + BLOCK



CE

EN  
795:2012 E  































### H-RAIL ON FLOOR



EN  
795:2012 D

CEN/TS  
16415:2013  

UNI  
11578:2015  
D  

device type	Type A	Type B	Type C	Type D	Type E	CEN/TS 16415:2013	Type A	Type C	Type D
<b>STANDARD</b>	EN 795:2012 + CEN/TS 16415:2013					UNI 11578:2015			
<b>CE</b>	-	●	-	-	●	-	-	-	-
<b>EAC</b>	-	-	-	-	-	-	-	-	-
<b>deformation test</b>	0,7 kN	0,7 kN	0,7 kN	0,7 kN	0,7 kN		0,7 kN	0,7 kN	0,7 kN
<b>dynamic test according to standard (applied load)</b>	9 kN	9 kN	9 kN	9 kN	9 kN	12 kN  9 kN + 2 kN  9 kN + 3 kN 	9 kN  12 kN  9 kN + 2 kN  9 kN + 3 kN 	9 kN  12 kN  9 kN + 2 kN  9 kN + 3 kN 	9 kN  12 kN  9 kN + 2 kN  9 kN + 3 kN 
<b>dynamic-mass test</b>	100 kg	100 kg	100 kg	100 kg	100 kg	100 kg / 200 kg	100 kg / 200 kg	100 kg / 200 kg	100 kg / 200 kg
<b>static test according to standard (applied load)</b>	12 kN	12 kN	12 kN	12 kN	12 kN	13 kN  14 kN  15 kN 	12 kN  13 kN  14 kN  15 kN 	12 kN  13 kN  14 kN  15 kN 	12 kN  13 kN  14 kN  15 kN 

Comparable mechanical tests between the various standards were considered.

**V-RAIL**



**CE**

EN 353-1:2014 + A1:2017  
RfU 11.119

**VERTIGRIP**



**CE EAC**

EN 353-1:2014 + A1:2017  
RfU 11.119















**WING**



**EAC**

EN 795:2012 A  
CEN/TS 16415:2013  
UNI 11578:2015 A

AS/NZS 5532:2013  
AS/NZS 1891.4:2009  
ANSI Z359.18/A

STANDARD	TP TC 019/2011	EN 353-1:2014 + A1:2017, RfU11.119	ANSI Z359.18/A	AS/NZS 5532:2013 AS/NZS 1891.4:2009	AS/NZS 1891.2:2001 AS/NZS 1891.4:2009
CE	-	●	-	-	-
EAC	●	-	-	-	-
deformation test	0,7 kN	-	-	-	-
dynamic test according to standard (applied load)	9 kN  12 kN  9 kN + 2 kN  9 kN + 3 kN 	●	-	-	-
dynamic-mass test	1100 kg / 200 kg	100 kg	128 kg	100 kg  150 kg 	100 kg
static test according to standard (applied load)	12 kN  13 kN  14 kN  15 kN 	min. 15 kN 	22,2 kN 	15 kN  21 kN 	15 kN 



# LIFELINE AND RAIL SYSTEMS

## LIFELINE AND RAIL SYSTEMS

### HORIZONTAL LIFELINE

---

<b>PATROL   OVERVIEW</b> .....	19
<b>PATROL + TOWER</b>	
LIFELINE ON SUPPORT FOR TIMBER, CONCRETE AND STEEL ROOFS .....	22
<b>PATROL + TOWER A2</b>	
LIFELINE ON STAINLESS STEEL SUPPORT ON TIMBER, STEEL AND CONCRETE ROOFS .....	24
<b>PATROL + TOWER XL</b>	
LIFELINE ON SUPPORT WITH INCREASED BOTTOM PLATE FOR TIMBER, STEEL AND CONCRETE ROOFS .....	26
<b>PATROL + SHIELD   SHIELD 2</b>	
LIFELINE ON SUPPORT FOR TRAPEZOIDAL METAL ROOFS WITH AND WITHOUT INSULATION LAYER .....	28
<b>PATROL + SIANK 4   SIANKINT</b>	
LIFELINE ON SUPPORT FOR STANDING SEAM METAL ROOFS ..	30
<b>PATROL + SEAMO</b>	
LIFELINE ON SUPPORT FOR ROUND SEAM METAL ROOFS ....	32
<b>PATROL + COPPO</b>	
LIFELINE ON SUPPORT FOR ROOFS WITH FAUX TILES .....	34
<b>PATROL + TWIST</b>	
LIFELINE ON SUPPORT FOR CONTINUOUS ROOFS AND PVC/TPO AND OSB ROOFS .....	36
<b>PATROL + BLOCK</b>	
LIFELINE ON SUPPORT WITH BALLAST FOR FLAT ROOFS ....	38
<b>PATROL + PATROLEND</b>	
LIFELINE WITH DIRECT FASTENING ON STEEL AND CONCRETE SUBSTRUCTURES .....	40
<b>PATROL OVERHEAD</b>	
OVERHEAD LIFELINE ON STEEL AND CONCRETE .....	42
<b>PATROL ON WALL</b>	
WALL-MOUNTED LIFELINE ON STEEL AND CONCRETE .....	44
<b>PATROL A4</b>	
LIFELINE WITH A4 STAINLESS STEEL COMPONENTS .....	46
<b>PATROL   COMPONENTS</b> .....	48
<b>PATROL   TENSIONERS WITH ABSORBER</b> .....	52
<b>PATROL   INTERMEDIATE - ANGLE BRACKETS</b> .....	53



## VERTICAL LIFELINE

---

VERTIGRIP   OVERVIEW .....	55
<b>VERTIGRIP ON LADDER</b>	
VERTICAL LIFELINE ON LADDERS .....	56
<b>VERTIGRIP ON WALL</b>	
VERTICAL LIFELINE ON WALL .....	58
<b>VERTIGRIP A4</b>	
VERTICAL LIFELINE WITH A4 STAINLESS STEEL ELEMENTS .....	60
VERTIGRIP   COMBINATIONS .....	62
VERTIGRIP   COMPONENTS .....	64
VERTIGRIP   SLIDING DEVICES .....	67

## HORIZONTAL RAIL

---

H-RAIL   OVERVIEW .....	71
<b>H-RAIL ON FLOOR</b>	
HORIZONTAL RAIL SYSTEM .....	72
<b>H-RAIL + TOWER</b>	
HORIZONTAL RAIL SYSTEM ON SUPPORTS .....	74
<b>H-RAIL OVERHEAD</b>	
HORIZONTAL OVERHEAD RAIL SYSTEM .....	76
<b>H-RAIL ON WALL</b>	
HORIZONTAL WALL-MOUNTED RAIL SYSTEM .....	78
H-RAIL   COMPONENTS .....	80

## VERTICAL RAIL

---

<b>V-RAIL</b>	
VERTICAL RAIL SYSTEM .....	82

## GREEN ROOF LIFELINE

---

<b>GREEN LINE</b>	
LIFE LINE ON SUPPORTS WITH BALLAST .....	86
<b>GREEN LINE   COMPONENTS</b> .....	88

## TEMPORARY DEVICES

---

TEMPORARY DEVICES .....	90
<b>TEMPORARY</b>	
TEMPORARY LIFE LINE .....	90
<b>HOLD-SYSTEM®</b>	
TEMPORARY HORIZONTAL ANCHORING DEVICE .....	91

# PATROL

## HORIZONTAL LIFELINE

### MODULAR, SIMPLE, SAFE SYSTEM.

With PATROL LIFELINE SYSTEMS, horizontal, overhead or façade life-lines, both through and overhead, are child's play. Dedicated brackets allow you to quickly install the system on timber, metal or concrete substrates, and with the wide selection of specific accessories it is easy to meet all project requirements.

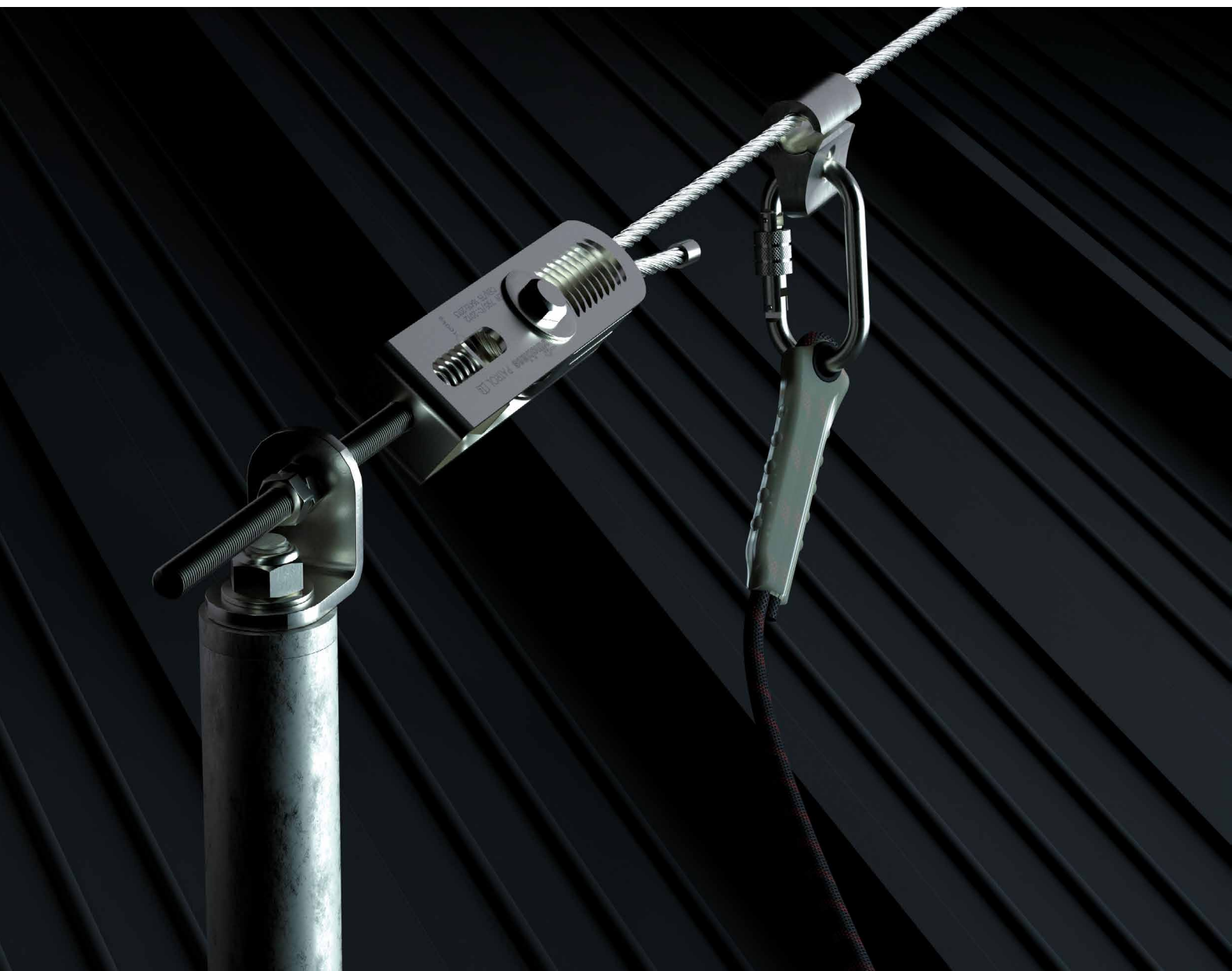
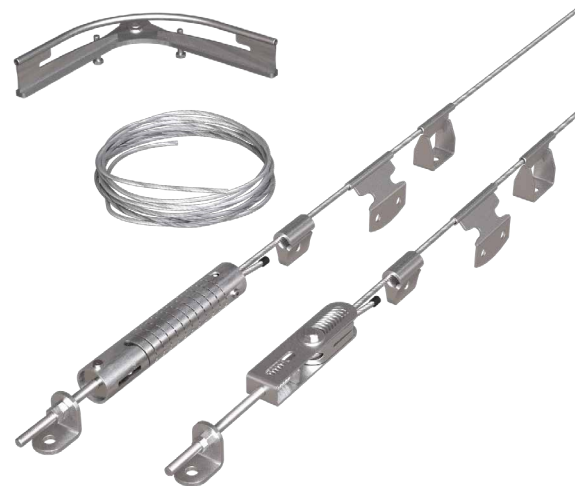

# PATROL | overview

## PATROL + TOWER

LIFILINE ON SUPPORT FOR TIMBER, CONCRETE AND STEEL ROOFS

EAC

EN 795:2012 C	CEN/TS 16415:2013	UNI 11578:2015 C	AS/NZS 1891.2:2001	AS/NZS 1891.4:2009
------------------	----------------------	---------------------	-----------------------	-----------------------



► PAGE 22

## PATROL + TOWER A2

LIFILINE ON STAINLESS STEEL SUPPORT FOR TIMBER, STEEL AND CONCRETE ROOFS

A2  
AISI 304

EN 795:2012 C	CEN/TS 16415:2013	UNI 11578:2015 C	AS/NZS 1891.2:2001	AS/NZS 1891.4:2009
------------------	----------------------	---------------------	-----------------------	-----------------------

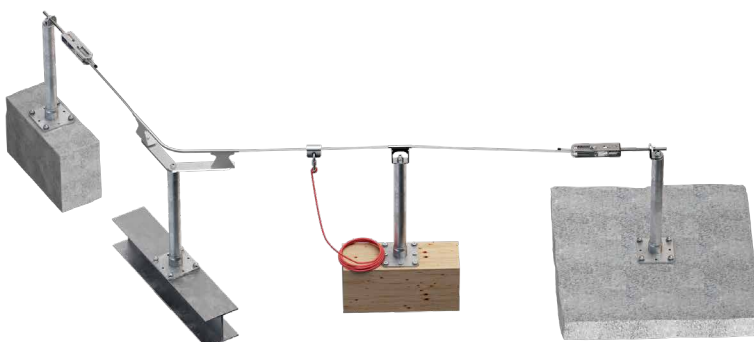

► PAGE 24

## PATROL + TOWER XL

LIFILINE ON SUPPORT WITH INCREASED BOTTOM PLATE FOR TIMBER, STEEL AND CONCRETE ROOFS

EN 795:2012 C	CEN/TS 16415:2013	UNI 11578:2015 C
------------------	----------------------	---------------------



► PAGE 26

## PATROL + SHIELD | SHIELD 2

LIFILINE ON SUPPORT FOR TRAPEZOIDAL METAL ROOFS WITH AND WITHOUT INSULATION LAYER

EAC

A2  
AISI 304

EN 795:2012 C	CEN/TS 16415:2013 SPEAR	UNI 11578:2015 C SPEAR	AS/NZS 1891.2:2001	AS/NZS 1891.4:2009
	CEN/TS 16415:2013 SPEAREVO	UNI 11578:2015 C SPEAREVO		

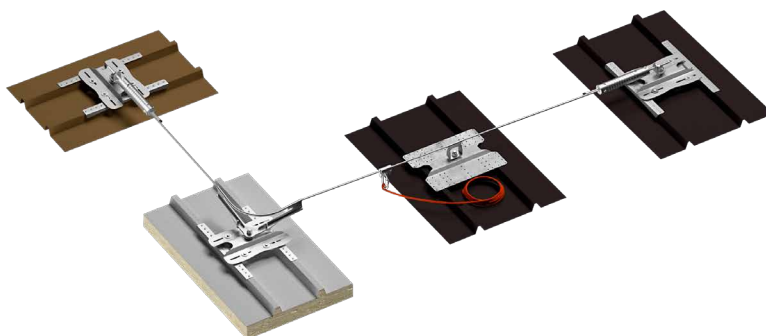

► PAGE 28

## PATROL + SIANK 4 | SIANKINT

LIFELINE ON SUPPORT  
FOR STANDING SEAM METAL ROOFS

ERC

A2  
AISI 304

EN  
795:2012 C

CEN/TS  
16415:2013

UNI  
11578:2015 C

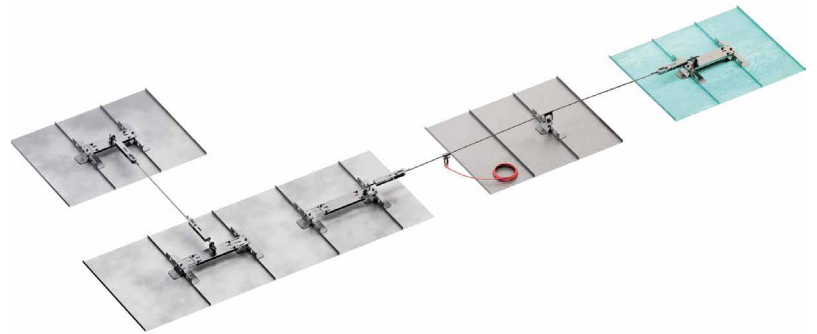

▶ PAGE 30

## PATROL + SEAMO

LIFELINE ON SUPPORT  
FOR ROUND SEAM METAL ROOFS

A2  
AISI 304

EN  
795:2012 C

CEN/TS  
16415:2013

UNI  
11578:2015 C

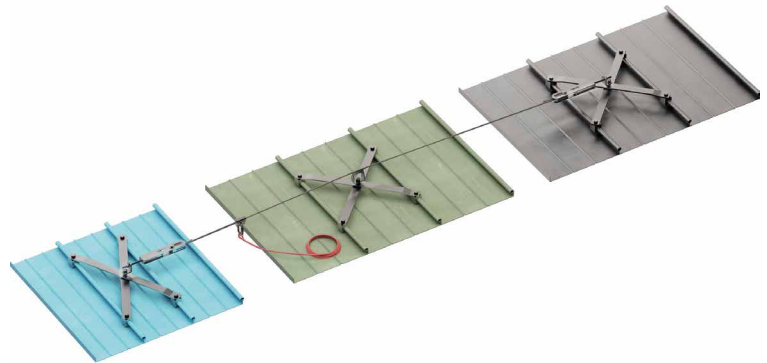

▶ PAGE 32

## PATROL + COPPO

LIFELINE ON SUPPORT ROOFS  
WITH FAUX TILES

A2  
AISI 304

EN  
795:2012 C

CEN/TS  
16415:2013

UNI  
11578:2015 C

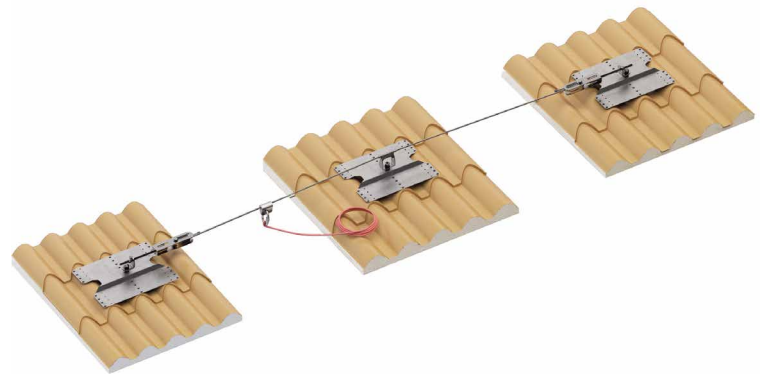

▶ PAGE 34

## PATROL + TWIST

LIFELINE ON SUPPORT FOR CONTINUOUS  
ROOFS AND PVC/TPO AND OSB ROOFS

A2  
AISI 304

EN  
795:2012 C

CEN/TS  
16415:2013

UNI  
11578:2015 C



▶ PAGE 36

## PATROL + BLOCK

LIFELINE ON SUPPORT  
WITH BALLAST FOR FLAT ROOFS

A2  
AISI 304

EN  
795:2012  
E + C

CEN/TS  
16415:2013

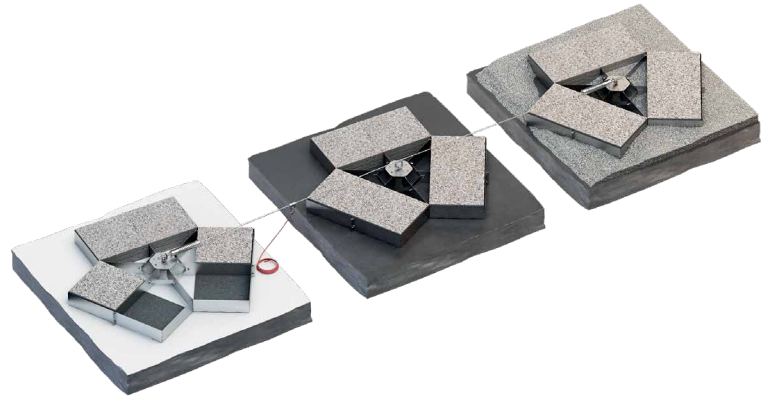

➤ PAGE 38

## PATROL + PATROLEND

LIFELINE WITH DIRECT FASTENING ON  
STEEL AND CONCRETE SUBSTRUCTURES

ETC

A2  
AISI 304

A4  
AISI 316

EN  
795:2012 C

CEN/TS  
16415:2013

UNI  
11578:2015 C

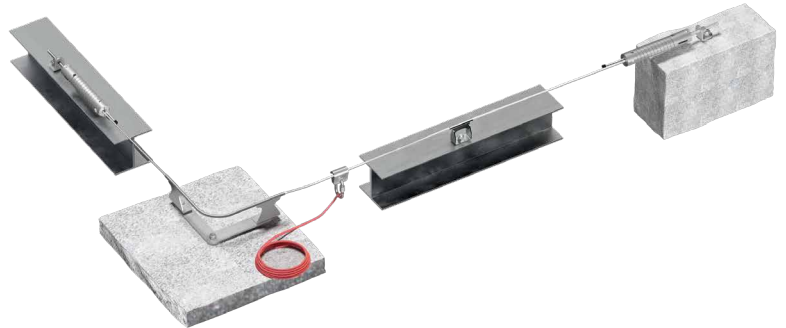

➤ PAGE 40

## PATROL OVERHEAD

OVERHEAD LIFELINE ON STEEL  
AND CONCRETE

ETC

A2  
AISI 304

A4  
AISI 316

EN  
795:2012 C

CEN/TS  
16415:2013

UNI  
11578:2015 C



➤ PAGE 42

## PATROL ON WALL

WALL-MOUNTED LIFELINE ON STEEL  
AND CONCRETE

ETC

A2  
AISI 304

A4  
AISI 316

EN  
795:2012 C

CEN/TS  
16415:2013

UNI  
11578:2015 C

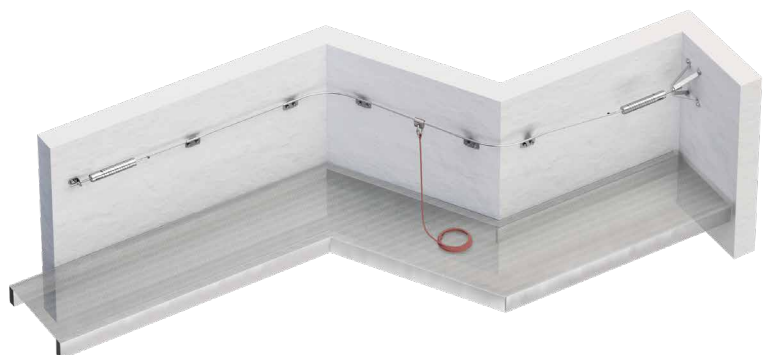

➤ PAGE 44

# PATROL + TOWER



## LIFELINE ON SUPPORT FOR TIMBER, CONCRETE AND STEEL ROOFS

EN 795:2012 C	CEN/TS 16415:2013	UNI 11578:2015 C	AS/NZS 1891.2:2001	AS/NZS 1891.4:2009

### ADJUSTABLE

Support height between 300 and 600 mm to adapt to different thicknesses of roofing packages.



### AESTHETICS

Small-sized cylindrical support to minimize the visual impact on the roofing.

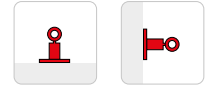

### SAFETY

Controlled deformation device to reduce the load on the fastening systems and structure.



LOAD DIRECTION



TYPES OF APPLICATION

VIDEO	MANUALS	

▼ *Installation of a PATROL lifeline on TOWER supports on a structural glulam roof.*



## PATROL LIFELINE COMPONENTS

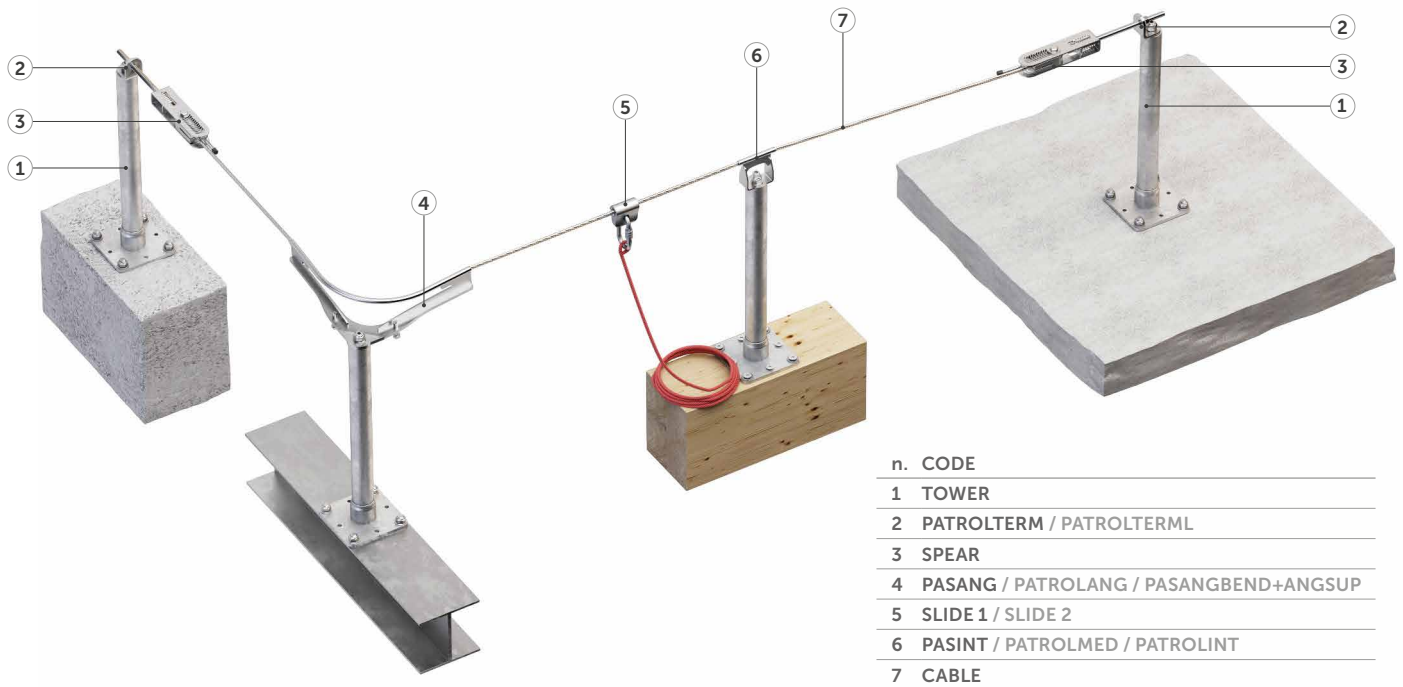

n.	CODE
1	TOWER
2	PATROLTERM / PATROLTERML
3	SPEAR
4	PASANG / PATROLANG / PASANGBEND+ANGSUP
5	SLIDE 1 / SLIDE 2
6	PASINT / PATROLMED / PATROLINT
7	CABLE

## TECHNICAL DATA\*

substructure	minimum thickness	fasteners
GL24h	160 x 160 mm	VGS Ø9
CLT	200 mm	VGS Ø9
C20/25	140 mm	AB1 Ø12
		rod Ø12
S235JR	6 mm	VIN-FIX
		HYB-FIX
S235JR	6 mm	EKS + ULS + MUT
		MUT

		with SPEAR
Minimum spacing	$X_{min}$ [m]	2
Maximum spacing	$X_{max}$ [m]	15
Maximum deflection	$Y_{max}$ [m]	3,26

\* The values indicated are the result of experimental tests carried out under the supervision of third parties in accordance with the standard referred to. For a calculation report with minimum distances according to the relevant standard requirements, the substructure must be checked by a qualified engineer before installation.

## TOWER | CODES AND DIMENSIONS

CODE	material	$d_1$ [mm]	B [mm]	H [mm]	L [mm]	pcs
TOWER300	S235JR zinc plated steel	48	150	300	150	1
TOWER400	S235JR zinc plated steel	48	150	400	150	1
TOWER500	S235JR zinc plated steel	48	150	500	150	1
TOWER600	S235JR zinc plated steel	48	150	600	150	1
TOWER22500	S235JR zinc plated steel	48	150	500	150	1

## COMPLEMENTARY PRODUCTS

CODE	description	page
TOWERPEAK	adaptor for double layer ridge piece	228
TOWERSLOPE	fastening guide for rafter	228
TOWLATEVO	TOWER fastening to the wall	229

CODE	description	page
TOPLATE	counterplate	229
BEF201VGS	fastening set	231
BEF202VGS	fastening set	231
MANPOST1	adhesive sealing sleeve for outdoors	232
MANPOST2	adhesive sealing sleeve for outdoors	232
MANEPDM	EPDM sleeve	232
MANLEAD	lead waterproofing cover	232

# PATROL + TOWER A2

LIFELINE ON STAINLESS STEEL SUPPORT  
ON TIMBER, STEEL AND CONCRETE ROOFS

EN 795:2012 C	CEN/TS 16415:2013	UNI 11578:2015 C	AS/NZS 1891.2:2001	AS/NZS 1891.4:2009
------------------	----------------------	------------------------	-----------------------	-----------------------

## MATERIAL

A2 stainless steel support that guarantees excellent resistance and durability in corrosive environments.

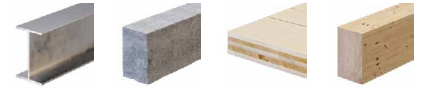

## AESTHETICS

Product that meets high aesthetic and functional requirements.

## SAFETY

Controlled deformation device to reduce the load on the fastening systems and structure.

 LOAD DIRECTION	 TYPES OF APPLICATION
--------------------	--------------------------

▼ Installation of a PATROL lifeline with stainless steel TOWER A2 steel supports on a structure close to the edge.

 VIDEO	 MANUALS	
-----------	-------------	--





## PATROL LIFELINE COMPONENTS

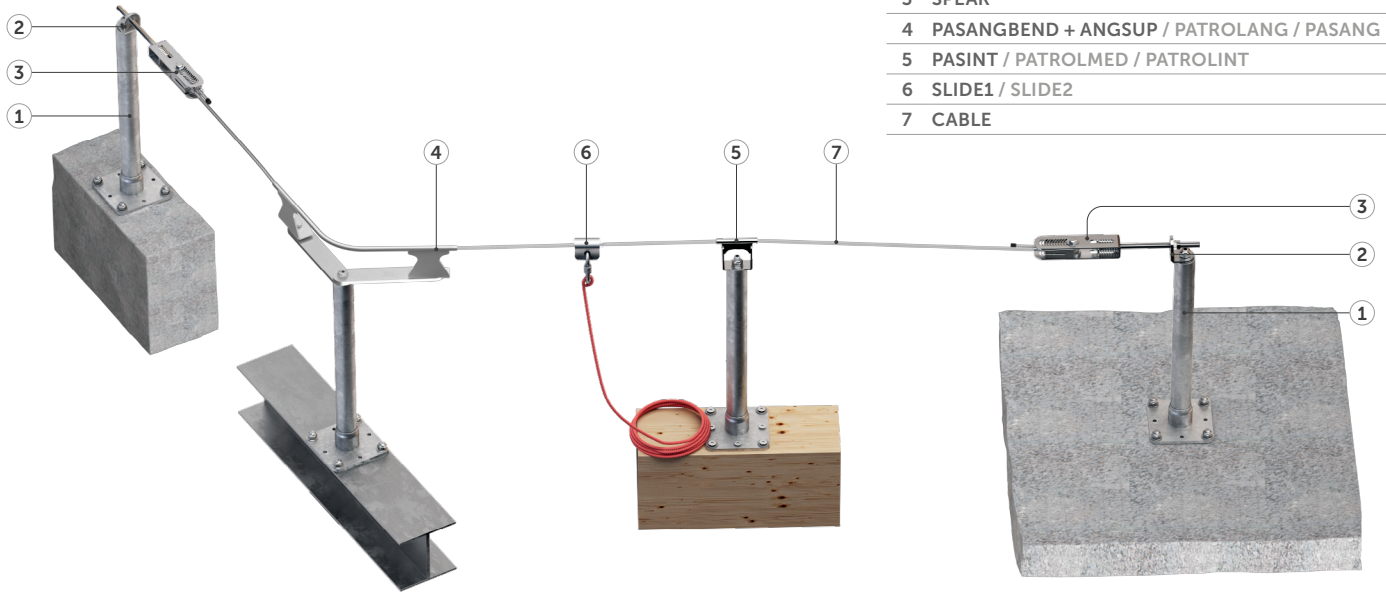

n. CODE

1	TOWER A2
2	PATROLTERM / PATROLTERML
3	SPEAR
4	PASANGBEND + ANGSUP / PATROLANG / PASANG
5	PASINT / PATROLMED / PATROLINT
6	SLIDE1 / SLIDE2
7	CABLE

## TECHNICAL DATA\*

substructure	minimum thickness	fasteners
GL24h	160 x 160	VGS Ø9
CLT	200	VGS Ø9
C20/25	140	AB1 Ø12
		rod Ø12
S235JR	6	VIN-FIX
		HYB-FIX
		EKS + ULS + MUT

		with SPEAR
Minimum spacing	$X_{min}$ [m]	2
Maximum spacing	$X_{max}$ [m]	15
Maximum deflection	$Y_{max}$ [m]	3,26

\* The values indicated are the result of experimental tests carried out under the supervision of third parties in accordance with the standard referred to. For a calculation report with minimum distances according to the relevant standard requirements, the substructure must be checked by a qualified engineer before installation.

## TOWER A2 | CODES AND DIMENSIONS

A2  
AISI 304

CODE	material	$d_1$ [mm]	B [mm]	H [mm]	L [mm]	pcs
TOWERA2300	AISI 304 stainless steel grade 1.4301	48	150	300	150	1
TOWERA2400	AISI 304 stainless steel grade 1.4301	48	150	400	150	1
TOWERA2500	AISI 304 stainless steel grade 1.4301	48	150	500	150	1

## COMPLEMENTARY PRODUCTS

CODE	description	page
BEF201VGS	fastening set	231
BEF202VGS		
MANPOST1	adhesive sealing sleeve for outdoors	232
MANPOST2		

CODE	description	page
MANEPDM	EPDM sleeve	232
MANLEAD	lead waterproofing cover	

# PATROL + TOWER XL

LIFELINE ON SUPPORT WITH INCREASED BOTTOM PLATE FOR TIMBER, STEEL AND CONCRETE ROOFS

## VERSATILE

It can be mounted on various types of structure with tested fastenings.

## ADJUSTABLE

Support height between 300 and 800 mm to adapt to different thicknesses of roofing packages.

## SAFE

The enlarged bottom plate makes it possible to distribute the actions arising from the anchoring devices over a larger area.



LOAD DIRECTION



TYPES OF APPLICATION

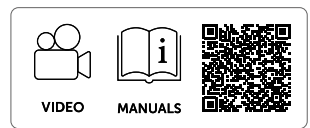

▼ Installation of a PATROL lifeline with TOWER XL supports on a flat roof with CLT structure and waterproofed with a synthetic covering.



## PATROL LIFELINE COMPONENTS

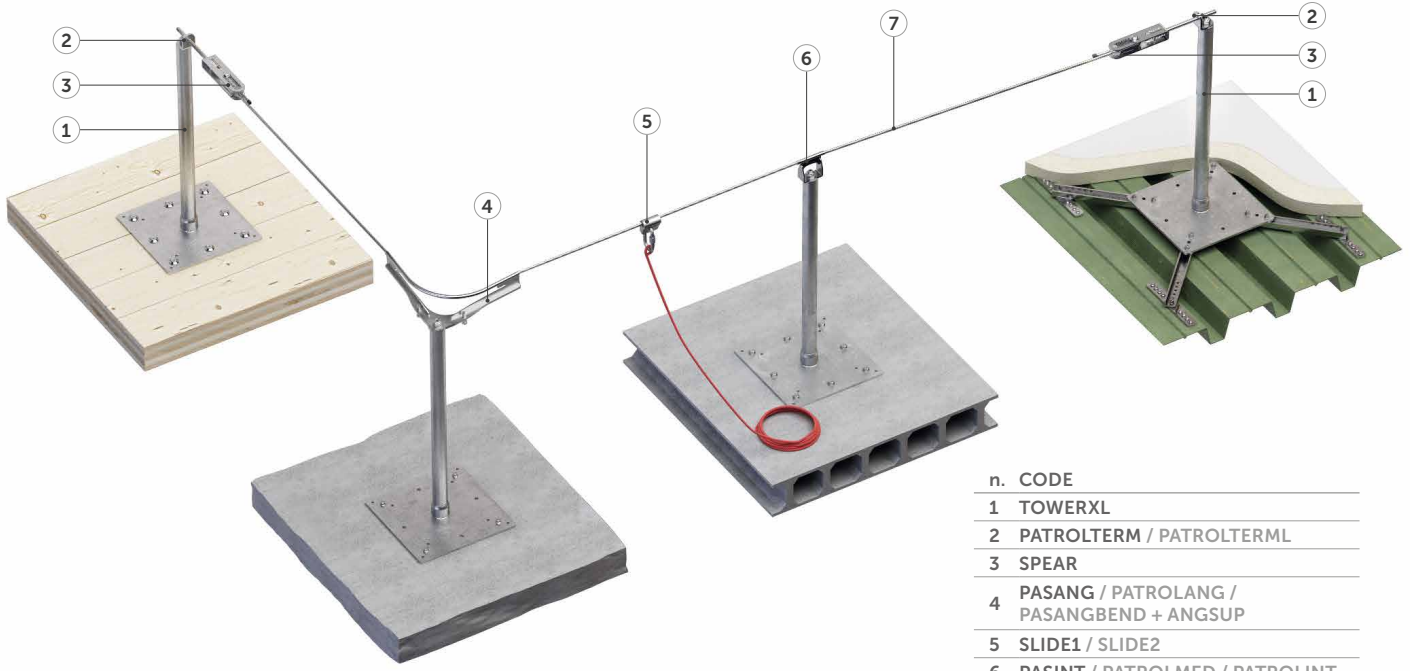

n.	CODE
1	TOWERXL
2	PATROLTERM / PATROLTERML
3	SPEAR
4	PASANG / PATROLANG / PASANGBEND + ANGSUP
5	SLIDE1 / SLIDE2
6	PASINT / PATROLMED / PATROLINT
7	CABLE

## TECHNICAL DATA\*

substructure	minimum thickness	fasteners
CLT	100 mm	VGS Ø11
C20/25	110 mm	AB7 Ø10
		rod Ø10
		VIN-FIX
C45/55	30 mm	BEFTOWERXL1
	0,75 mm	MTS A2 AISI 304

		with SPEAR
minimum spacing	$X_{min}$ [m]	2
maximum spacing	$X_{max}$ [m]	15
maximum deflection	$Y_{max}$ [m]	3,60

\* The values indicated are the result of experimental tests carried out under the supervision of third parties in accordance with the standard referred to. For a calculation report with minimum distances according to the relevant standard requirements, the substructure must be checked by a qualified engineer before installation.

## TOWER XL | CODES AND DIMENSIONS

CODE	material	$d_1$	B	H	L	pcs
		[mm]	[mm]	[mm]	[mm]	
TOWERXL300	S235JR zinc plated steel	48	350	300	350	1
TOWERXL400	S235JR zinc plated steel	48	350	400	350	1
TOWERXL500	S235JR zinc plated steel	48	350	500	350	1
TOWERXL600	S235JR zinc plated steel	48	350	600	350	1
TOWERXL700	S235JR zinc plated steel	48	350	700	350	1
TOWERXL800	S235JR zinc plated steel	48	350	800	350	1

## COMPLEMENTARY PRODUCTS

CODE	description	page	
MANPOST1	adhesive sealing sleeve for outdoors	232	
MANPOST2			
MANEPDM	EPDM sleeve	232	
MANLEAD	lead waterproofing cover	232	

CODE	description	page	
TOPLATE 2.0	counterplate	230	
TRAPO	support for trapezoidal steel deck	230	
BEFTOWERXL1	fastening set for aerated cement	231	

# PATROL + SHIELD | SHIELD 2



## LIFELINE ON SUPPORT FOR TRAPEZOIDAL METAL ROOFS WITH AND WITHOUT INSULATION LAYER

### COMPLETE

The package includes fasteners and cellular rubber seals, to ensure waterproofing.

### APPLICATION

Used on all trapezoidal metal roofs with and without insulation layer with spacing between frets of up to 420 mm.

### USE

SHIELD for use as a start, end or corner lifeline; SHIELD 2 for use as a straight intermediate point.



LOAD DIRECTION



TYPES OF APPLICATION



▼ Installation of a PATROL lifeline with SHIELD supports on a steel sandwich panel roof.



## PATROL LIFELINE COMPONENTS

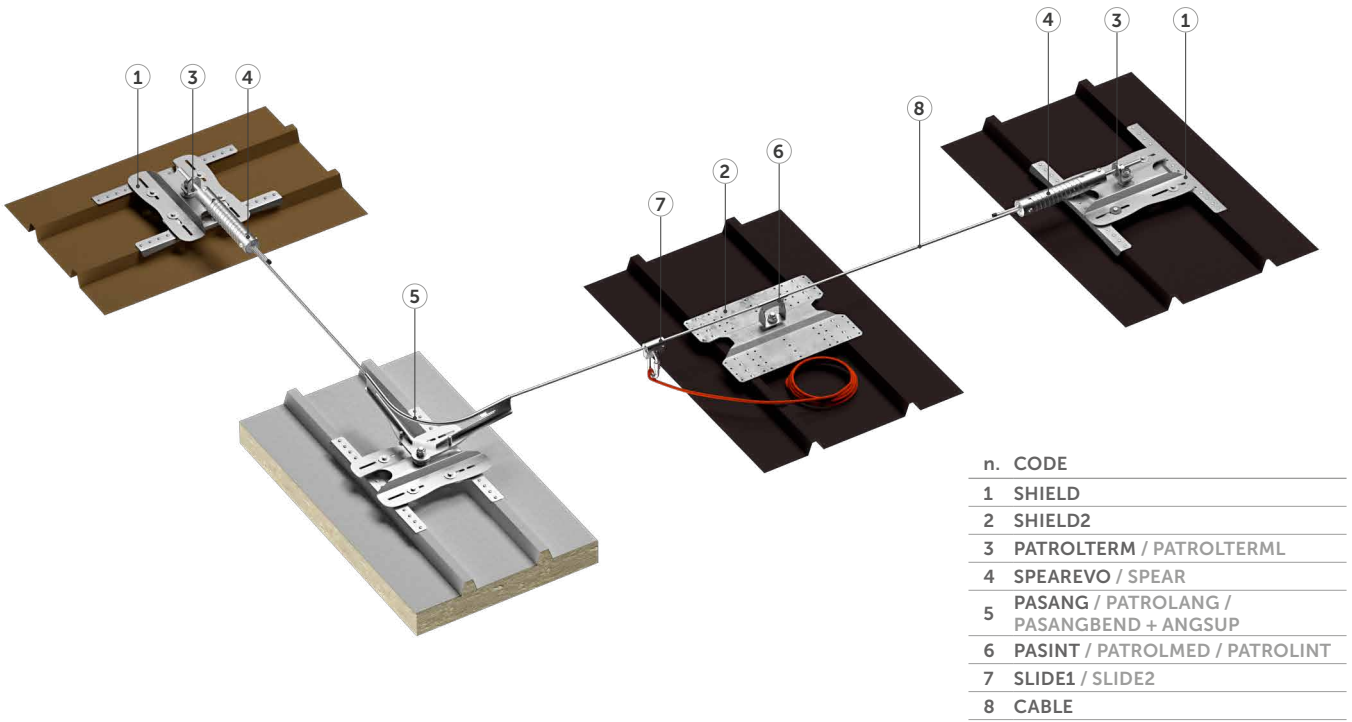

## TECHNICAL DATA\*

substructure	minimum thickness	fastening systems included
 Fe	0,5 mm	SHIELD: rivet 6,3 x 20,2 mm with EPDM washer (x 32)
 Fe	0,5 mm	
 Al	1 mm	SHIELD2: rivet 6,3 x 20,2 mm with EPDM washer (x 16)
 Al	1 mm	

		with SPEAR	with SPEAREVO <b>NEW</b>
minimum spacing	$x_{min}$ [m]	2	2
maximum spacing	$x_{max}$ [m]	7,5	15
maximum deflection	$y_{max}$ [m]	1,44	3,40
users	n.	2	4

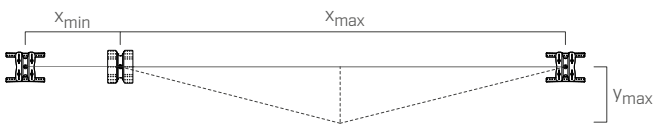

\* The values indicated are the result of experimental tests carried out under the supervision of third parties in accordance with the standard referred to. For a calculation report with minimum distances according to the relevant standard requirements, the substructure must be checked by a qualified engineer before installation.

## SHIELD | CODES AND DIMENSIONS

**A2**  
AISI 304

CODE	description	material	B	H	L	pcs
			[mm]	[mm]	[mm]	
SHIELD	lifeline support	AISI 304 stainless steel grade 1.4301	180-420	85	476	1

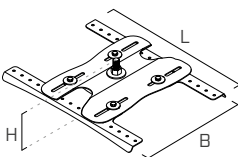

## SHIELD 2 | CODES AND DIMENSIONS

CODE	description	material	B	H	L	pcs
			[mm]	[mm]	[mm]	
SHIELD2	intermediate lifeline support	AISI 304 stainless steel grade 1.4301	250 - 370	65	322	1

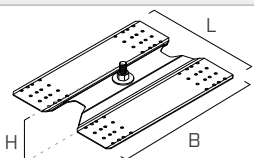

## COMPLEMENTARY PRODUCTS

CODE	description	pcs
RIV6320	rivets 6,3 x 20,2 mm with EPDM washer	33

# PATROL + SIANK 4 | SIANKINT



## LIFELINE ON SUPPORT FOR STANDING SEAM METAL ROOFS



### PRACTICAL

The system can be installed on existing roofs without having to remove the metal sheet.

### SAFE

Installation does not require the sheet metal to be drilled, thanks to the gripper which distributes the load over the double seam, thus ensuring the integrity of the building envelope.

### SIMPLE

Designed to ensure quick and easy assembly with just a few tools.



LOAD DIRECTION



TYPES OF APPLICATION



▼ *Installation of a PATROL lifeline with SIANK 4 supports on standing seam sheet.*





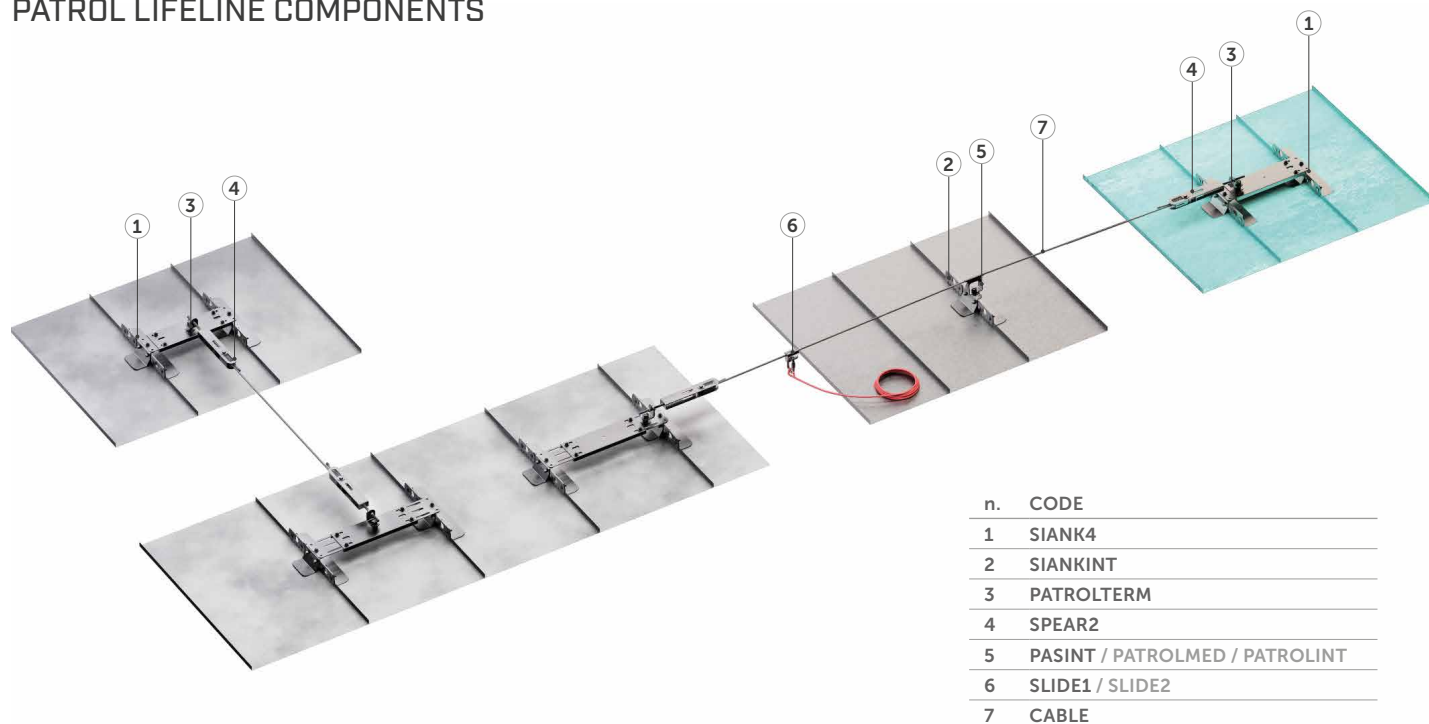

## PATROL LIFELINE COMPONENTS



n.	CODE
1	SIANK4
2	SIANKINT
3	PATROLTERM
4	SPEAR2
5	PASINT / PATROLMED / PATROLINT
6	SLIDE1 / SLIDE2
7	CABLE

## TECHNICAL DATA\*

substructure	minimum thickness
 Fe	0,5 mm
 Al	0,7 mm
 Cu	0,5 mm
 Zn - Ti	0,7 mm
 stainless steel	0.4 mm

		with SPEAR2
minimum spacing	$X_{min}$ [m]	4
maximum spacing	$X_{max}$ [m]	8
maximum recommended system length	L [m]	50
maximum deflection	$Y_{max}$ [m]	1,60



\* The values indicated are the result of experimental tests carried out under the supervision of third parties in accordance with the standard referred to. For a calculation report with minimum distances according to the relevant standard requirements, the substructure must be checked by a qualified engineer before installation.

## SIANK 4 | CODES AND DIMENSIONS

A2  
AISI 304

CODE	description	material	B [mm]	H [mm]	L [mm]	pcs
SIANK4	lifeline support	AISI 304 stainless steel grade 1.4301	430-600	90	400	1
SIANK465	lifeline support	AISI 304 stainless steel grade 1.4301	430-600	113	400	1

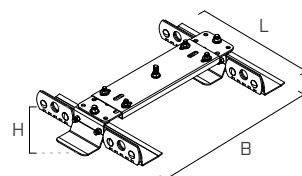

## SIANKINT | CODES AND DIMENSIONS

CODE	description	material	B [mm]	H [mm]	L [mm]	pcs
SIANKINT	intermediate lifeline support	AISI 304 stainless steel grade 1.4301	163	80	400	1
SIANKINT65	intermediate lifeline support	AISI 304 stainless steel grade 1.4301	104	113	400	1

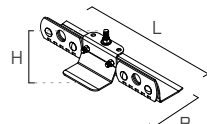

# PATROL + SEAMO

## LIFELINE ON SUPPORT FOR ROUND SEAM METAL ROOFS



### PRACTICAL

Device to be fastened to the seam with four clamps, without the need to make openings in the sheet metal.



### SAFE

The fastening is done on two round seams of the sheet, to ensure greater strength.

### SIMPLE

Fast and safe assembly on different spacing between seams.



LOAD DIRECTION



TYPES OF APPLICATION

▼ *Installation of a PATROL lifeline with SEAMO brackets on round seams*

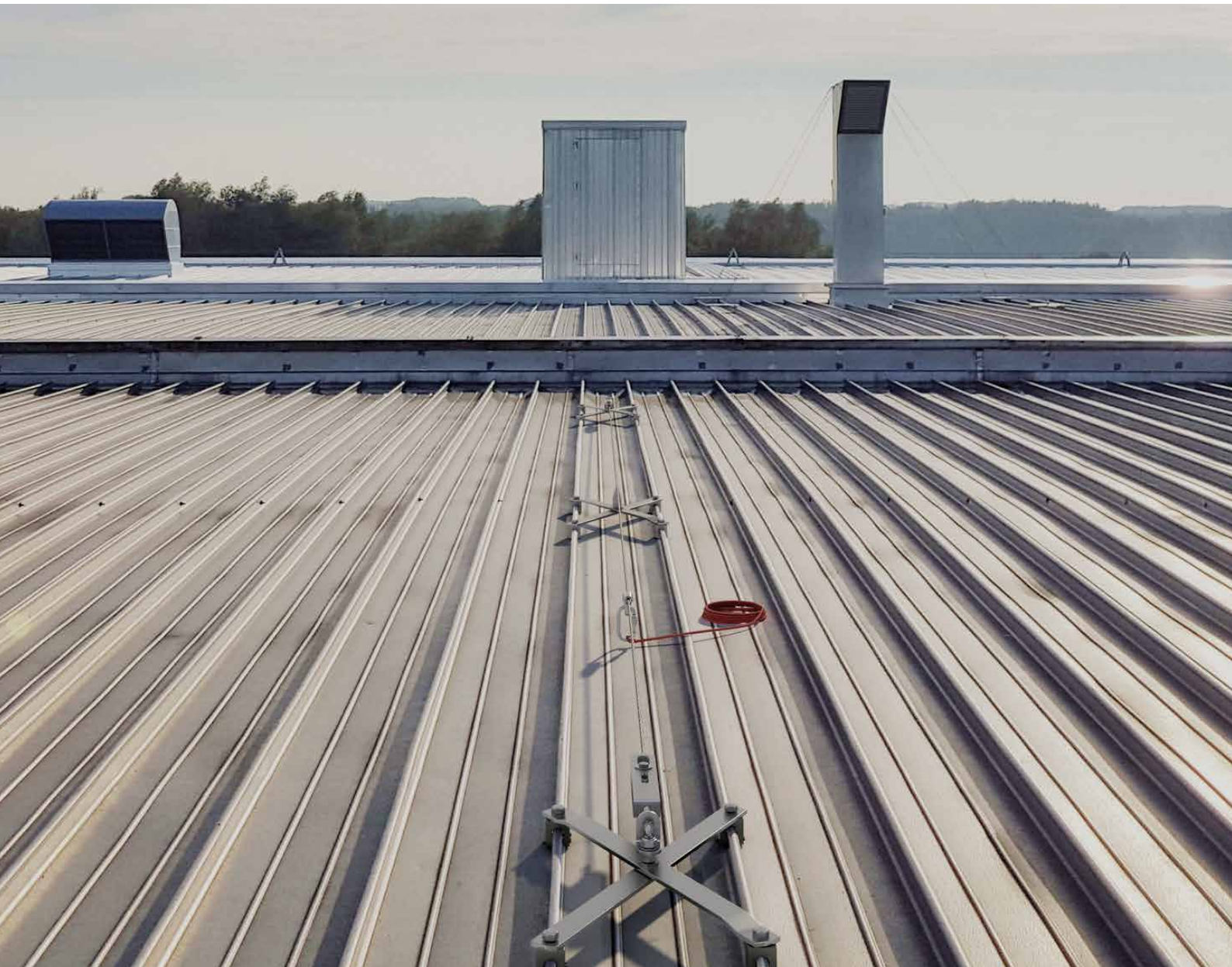



## PATROL LIFELINE COMPONENTS

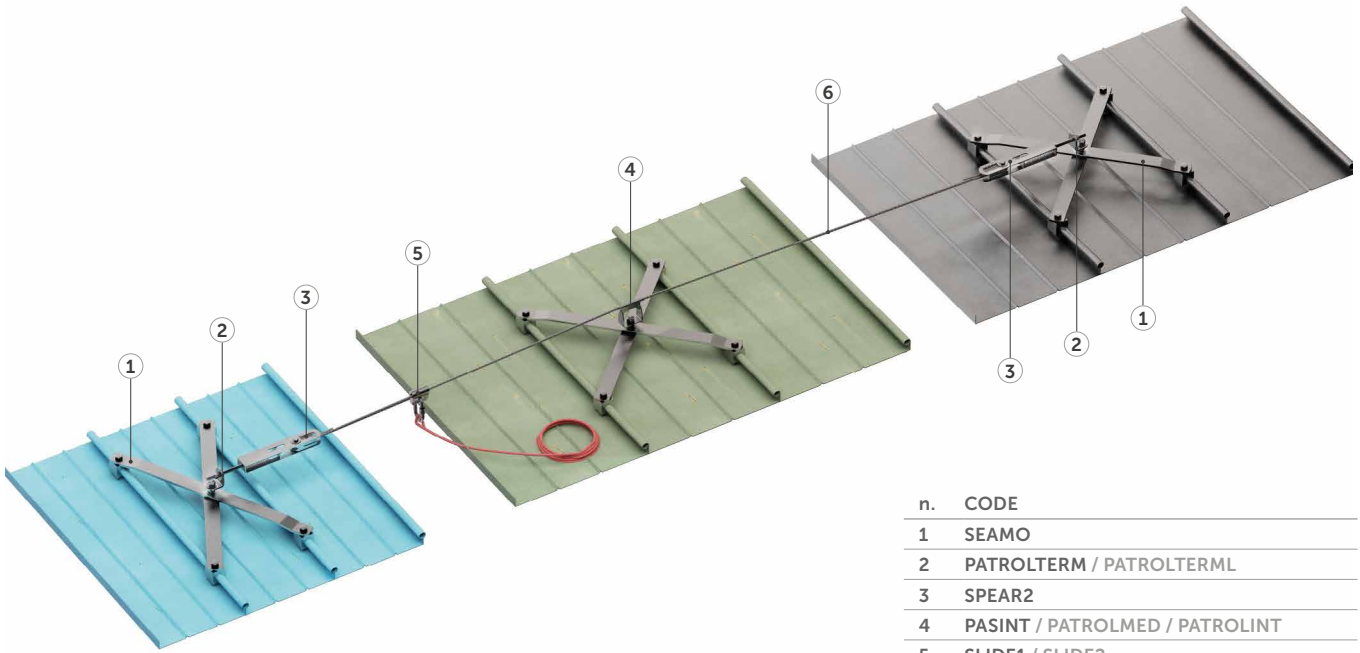

n.	CODE
1	SEAMO
2	PATROLTERM / PATROLTERML
3	SPEAR2
4	PASINT / PATROLMED / PATROLINT
5	SLIDE1 / SLIDE2
6	CABLE

## TECHNICAL DATA\*

substructure	minimum thickness
 ALUFALZ, INTERFALZ, BEMO ROOF, KALZIP Fe	0,6 mm
Al	0,8 mm

			with SPEAR2
minimum spacing	$X_{min}$	[m]	4
maximum spacing	$X_{max}$	[m]	10
maximum recommended system length	L	[m]	50
maximum deflection	$Y_{max}$	[m]	1,80

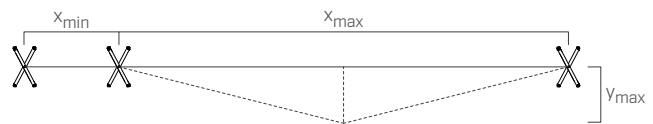

\* The values indicated are the result of experimental tests carried out under the supervision of third parties in accordance with the standard referred to. For a calculation report with minimum distances according to the relevant standard requirements, the substructure must be checked by a qualified engineer before installation.

## SEAMO | CODES AND DIMENSIONS

**A2**  
AISI 304

CODE	material	B [mm]	pcs
SEAMO	AISI 304 stainless steel grade 1.4301 - EN AW 6061 T6	305-500	1

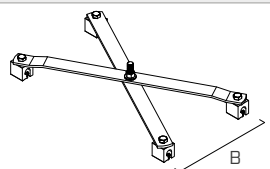

# PATROL + COPPO

## LIFELINE ON SUPPORT FOR ROOFS WITH FAUX TILES



### COMPLETE

The package includes fasteners and cellular rubber seals, to ensure roof waterproofing.



### ADJUSTABLE

Pre-drilled plate with holes at different distances to suit various types of sheet metal.

### FAST

Very quick assembly after covering with just a few tools.



LOAD DIRECTION



TYPES OF APPLICATION

▼ Installation of a PATROL lifeline with COPPO supports on a sandwich panel of the "faux tiles" type



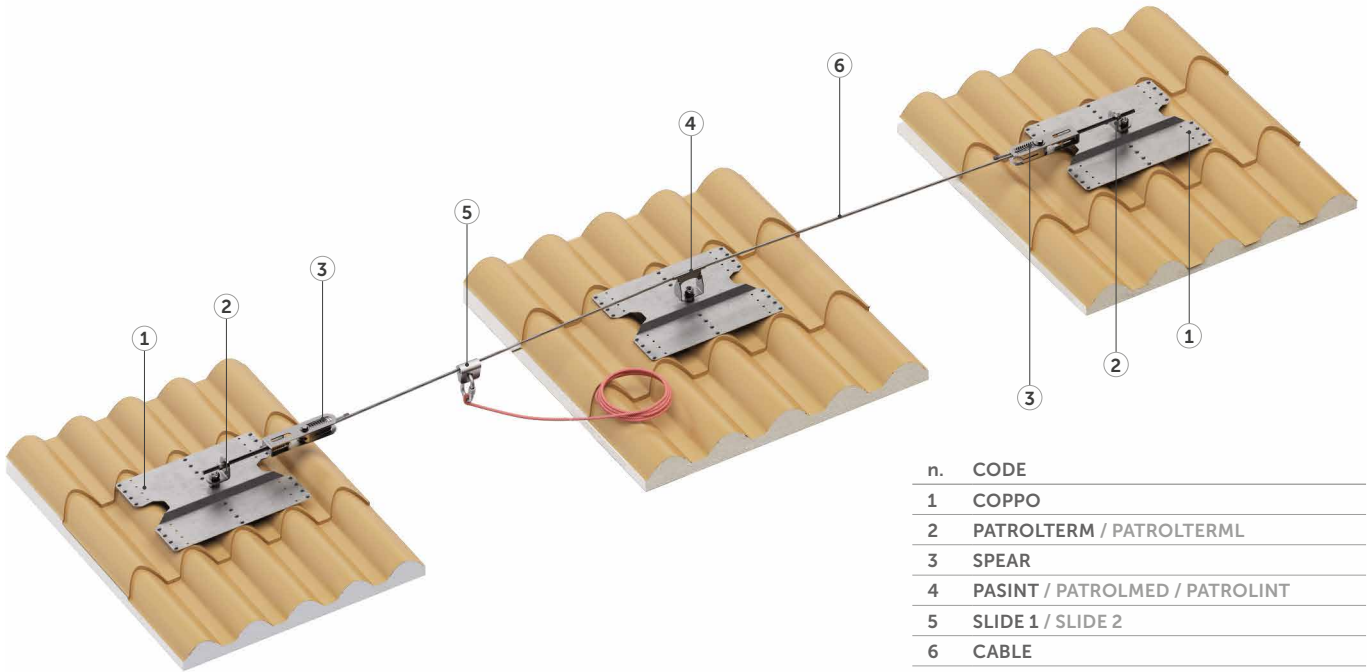

## PATROL LIFELINE COMPONENTS



n.	CODE
1	COPPO
2	PATROTERM / PATROTERML
3	SPEAR
4	PASINT / PATROLMED / PATROLINT
5	SLIDE 1 / SLIDE 2
6	CABLE

## TECHNICAL DATA\*

substructure	minimum thickness	fastening systems included
 Fe	0,5 mm	rivet 6,3 x 20,2 mm with EPDM washer (x 24) 
 Al	0,7 mm	

		with SPEAR
minimum spacing	$X_{min}$ [m]	2
maximum spacing	$X_{max}$ [m]	7,5
maximum deflection	$Y_{max}$ [m]	1,44

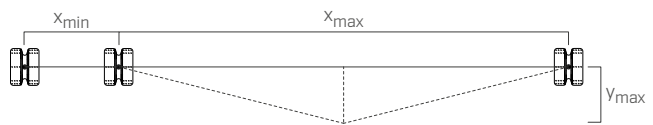

\* The values indicated are the result of experimental tests carried out under the supervision of third parties in accordance with the standard referred to. For a calculation report with minimum distances according to the relevant standard requirements, the substructure must be checked by a qualified engineer before installation.

## COPPO | CODES AND DIMENSIONS

A2  
AISI 304

CODE	material	B [mm]	H [mm]	L [mm]	pcs
COPPO	AISI 304 stainless steel grade 1.4301	166 - 200	65	322	1

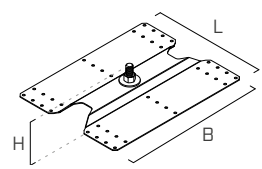

## COMPLEMENTARY PRODUCTS

CODE	description	pcs
RIV6320	rivets 6,3 x 20,2 mm with EPDM washer	33

# PATROL + TWIST

LIFELINE ON SUPPORT FOR CONTINUOUS ROOFS AND PVC/TPO AND OSB ROOFS



## UNIVERSAL

Unique fall absorption system offering solutions on several types of structure.

## ADJUSTABLE

The various sizes of the bottom plates guarantee a solution for every substructure and sheet metal option.

## SAFE

Certified fastening kits and installation accessories ensure that the structure is waterproofed to the highest standard.

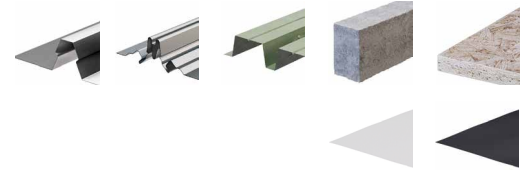

LOAD DIRECTION



TYPES OF APPLICATION

▼ *Installation of a PATROL lifeline with TWIST supports for continuous roofing.*



## PATROL LIFELINE COMPONENTS

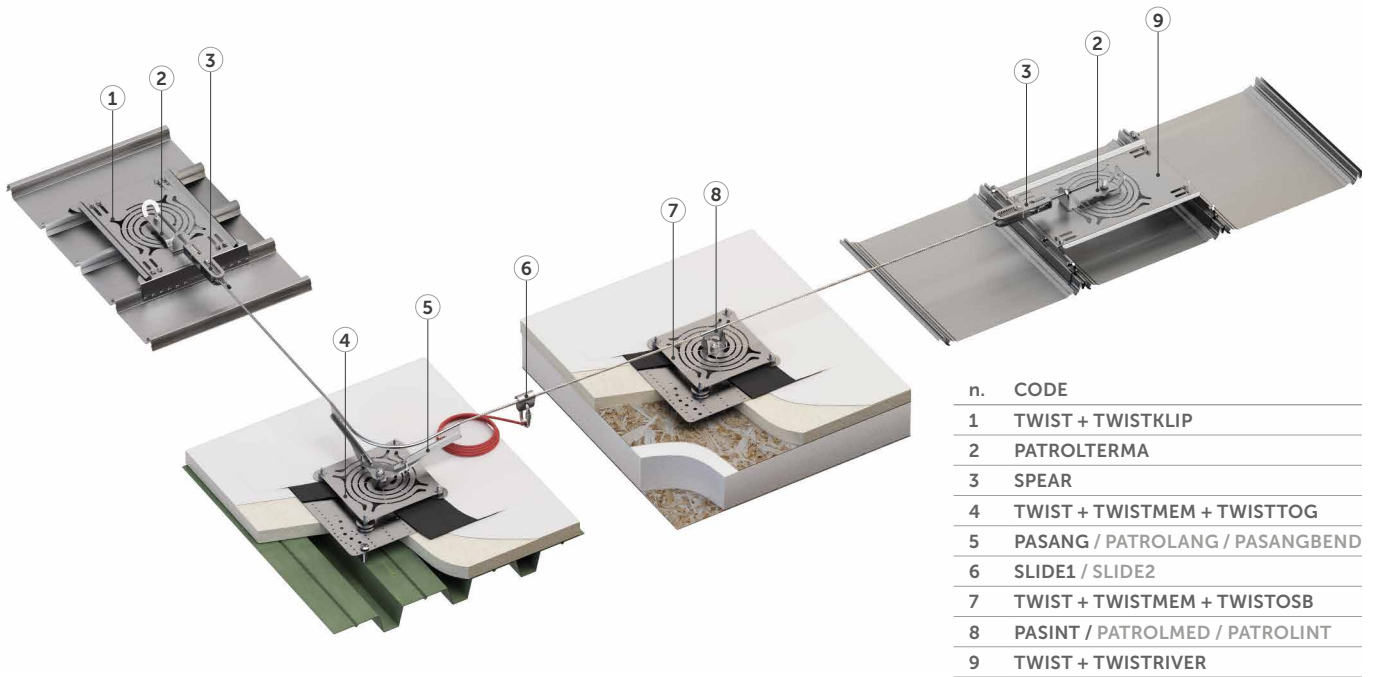

n.	CODE
1	TWIST + TWISTKLIP
2	PATROLTERMA
3	SPEAR
4	TWIST + TWISTMEM + TWISTTOG
5	PASANG / PATROLANG / PASANGBEND
6	SLIDE1 / SLIDE2
7	TWIST + TWISTMEM + TWISTOSB
8	PASINT / PATROLMED / PATROLINT
9	TWIST + TWISTRIVER

## TWIST | CODES AND DIMENSIONS

**A2**  
AISI 304

CODE	description	material	B [mm]	L [mm]	pcs	
TWIST300	universal plate	AISI 304 stainless steel grade 1.4301	300	300	1	
TWIST460	universal plate	AISI 304 stainless steel grade 1.4301	460	352	1	
TWIST540	universal plate	AISI 304 stainless steel grade 1.4301	540	352	1	
TWIST640	universal plate	AISI 304 stainless steel grade 1.4301	640	352	1	
TWISTRIVER	fastening kit for roofs Riverclack	AISI 304 stainless steel grade 1.4301	-	-	1	
TWISTKLIP	fastening kit for roofs Kliplok	AISI 304 stainless steel grade 1.4301	-	-	1	
TWISTMEM	fastening kit for roofs with membrane	AISI 304 stainless steel grade 1.4301	-	-	1	
PATROLTERMA	end element with anchor point	AISI 304 stainless steel grade 1.4301	235	60	1	
TWISTOSB	kit for fastening on OSB	bright zinc plated carbon steel	-	-	1	
TWISTTOG	fastening kit with toggle bolt	bright zinc plated carbon steel	-	-	1	
TWISTSCR	fastening kit with screws for metal	bright zinc plated carbon steel	-	-	1	



# PATROL + BLOCK

## LIFELINE ON SUPPORT WITH BALLAST FOR FLAT ROOFS

### WITHOUT DRILLING

It is designed for installation on flat roofs, and does not require to drill the roof covering, avoiding thermal bridges and preserving the waterproofing layer of the structure.

### FLAT ROOFS

Designed for flat roofs with inclines up to 5° with PVC or bituminous final covering, with or without gravel.

### SIMPLE

Concrete ballast slabs in standard sizes.



LOAD DIRECTION



TYPES OF APPLICATION

▼ *Installation of a PATROL lifeline on a flat roof using BLOCK ballast supports.*



## PATROL LIFELINE COMPONENTS

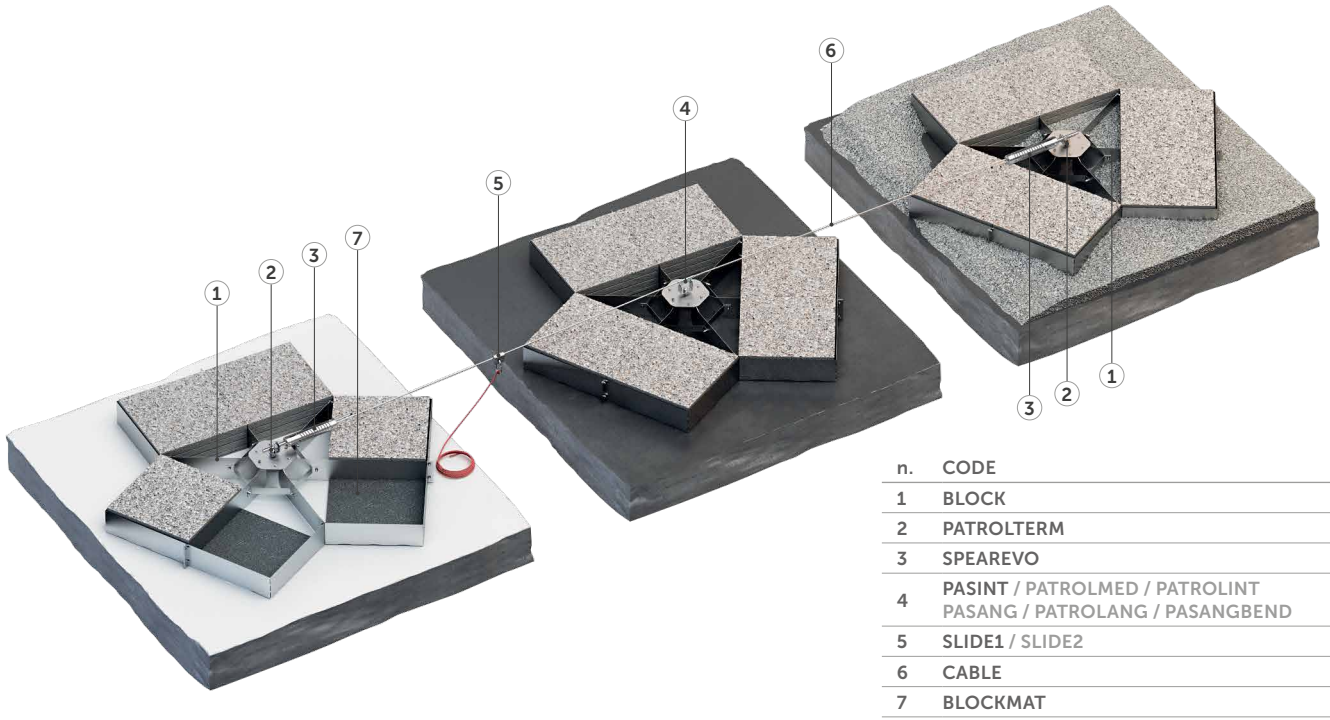

n.	CODE
1	BLOCK
2	PATROLMTERM
3	SPEAREVO
4	PASINT / PATROLMED / PATROLINT PASANG / PATROLANG / PASANGBEND
5	SLIDE1 / SLIDE2
6	CABLE
7	BLOCKMAT

## TECHNICAL DATA\*

		with SPEAREVO
minimum spacing	$X_{min}$ [m]	-
maximum spacing	$X_{max}$ [m]	-
maximum deflection	$Y_{max}$ [m]	-

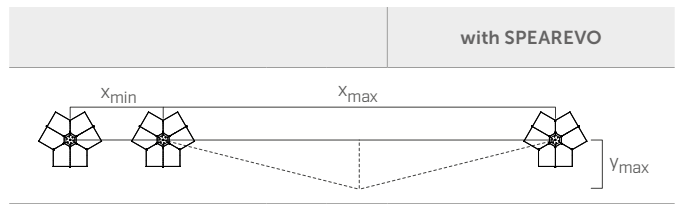

\* The values indicated are the result of experimental tests carried out under the supervision of third parties in accordance with the standard referred to. For a calculation report with minimum distances according to the relevant standard requirements, the substructure must be checked by a qualified engineer before installation.

## BLOCK | CODES AND DIMENSIONS



CODE	material	B	H	L	pcs
		[mm]	[mm]	[mm]	

BLOCK	AISI 304 stainless steel grade 1.4301	1870	165	1645	1
-------	---------------------------------------	------	-----	------	---



## COMPLEMENTARY PRODUCTS

CODE	description	B	L	s	pcs
		[mm]	[mm]	[mm]	

BLOCKMAT (1)	BLOCKMAT mats not included in the supply of the BLOCK item (3 pieces per BLOCK are required) it can be ordered separately.	550	1050	6	1
--------------	--	-----	------	---	---

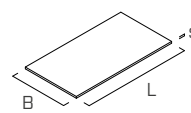

(1) Concrete slabs (500 x 500 x 40 mm) for ballasting not included (24 pieces per BLOCK to achieve a total weight of 530 kg).

Example of single system composition EN 795:2012 C+E:

- BLOCK 1 pc
- BLOCKMAT 3 pcs

# PATROL + PATROLEND



## LIFELINE WITH DIRECT FASTENING ON STEEL AND CONCRETE SUBSTRUCTURES



### EASY

Quick and easy assembly directly onto concrete or steel structure.



### UNIVERSAL

System designed for different applications: flat, façade, overhead.

### USE

Specially designed shuttles can be used to enable the operator to overcome bends and intermediate points without ever becoming disconnected from the system.



LOAD DIRECTION



TYPES OF APPLICATION

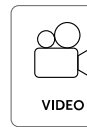

VIDEO



MANUALS



▼ *Installation of a PATROL lifeline directly on the steel or concrete supporting structure.*

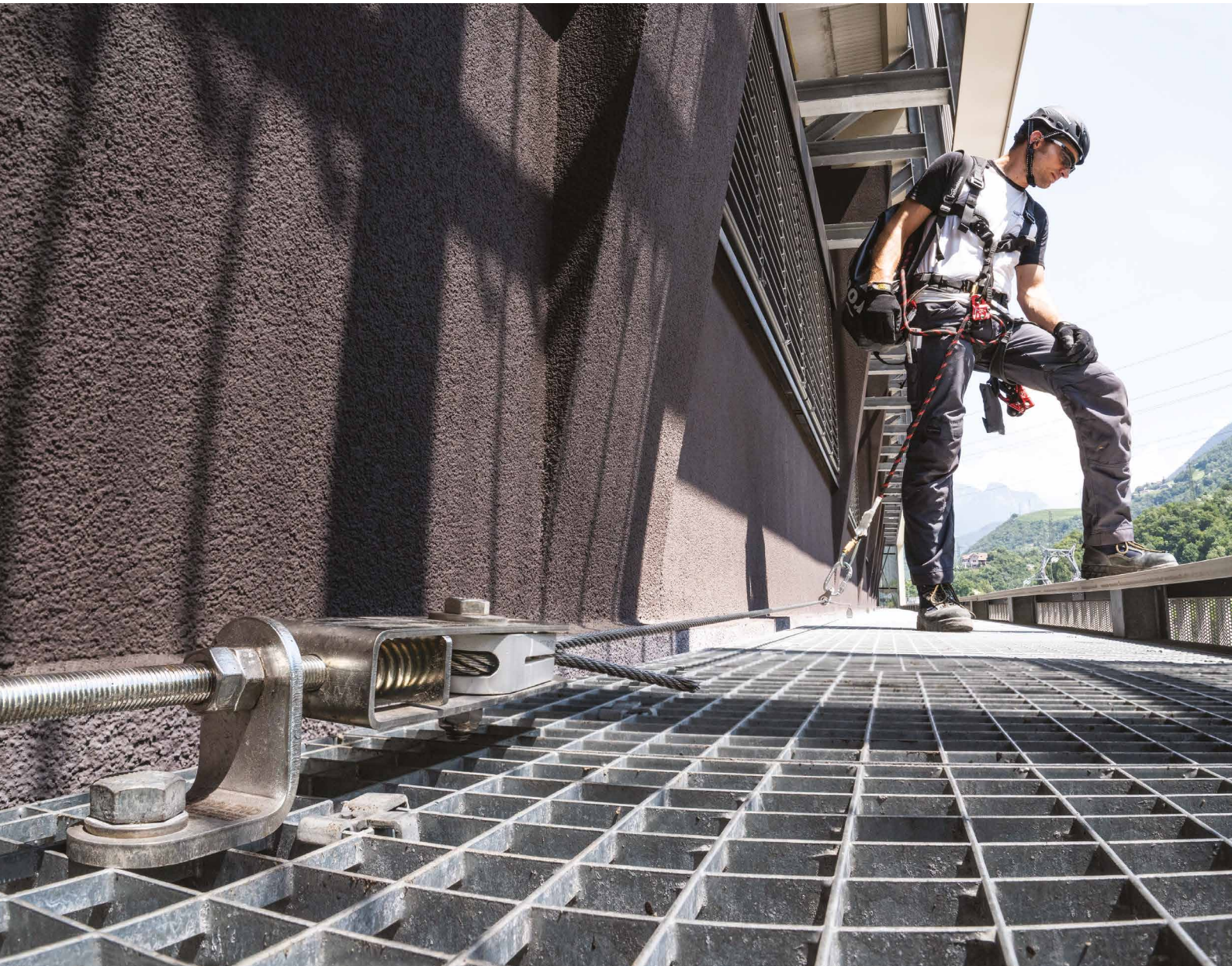



## PATROL LIFELINE COMPONENTS

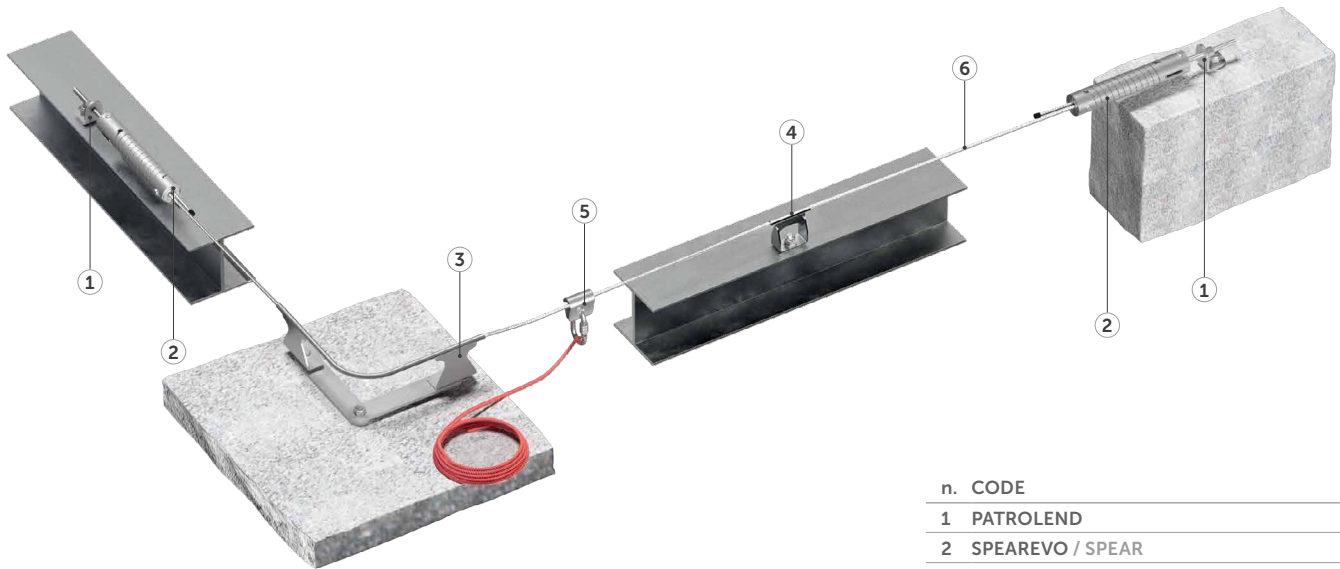

n. CODE

1	PATROLEND
2	SPEAREVO / SPEAR
3	PASANGBEND + ANGSUP / PASANG / PATROLANG
4	PASINT / PATROLMED / PATROLINT
5	SLIDE 1 / SLIDE 2
6	CABLE

## TECHNICAL DATA\*

substructure	minimum thickness	fasteners
C20/25	140 mm	rod Ø16 VIN-FIX HYB-FIX
S235JR	5 mm	EKS + ULS + MUT

		with SPEAR	with SPEAREVO <b>NEW</b>
minimum spacing	$X_{min}$ [m]	2	2
maximum spacing	$X_{max}$ [m]	7,5	15
maximum deflection	$Y_{max}$ [m]	1,30	3,35

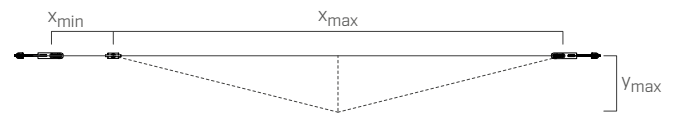

\* The values indicated are the result of experimental tests carried out under the supervision of third parties in accordance with the standard referred to. For a calculation report with minimum distances according to the relevant standard requirements, the substructure must be checked by a qualified engineer before installation.

## PATROLEND | CODES AND DIMENSIONS

**A2**  
AISI 304

CODE	material	B [mm]	H [mm]	L [mm]	s [mm]	pcs
PATROLEND	AISI 304 stainless steel grade 1.4301	40	61	66	6	1

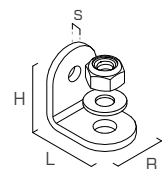

# PATROL OVERHEAD



## OVERHEAD LIFELINE ON STEEL AND CONCRETE



### APPLICATION

Lifeline for aerial applications such as maintenance of coaches, trucks, machinery and aeroplanes.



### SAFE

Sliding device that allows operators to pass intermediate elements and curves without ever disengaging from the system.

### PRACTICAL

Possibility of anchoring to the upside-down TOWER support to lower the lifeline relative to the ceiling.



LOAD DIRECTION



TYPES OF APPLICATION

▼ Installation of an overhead PATROL lifeline directly on the steel or concrete supporting structure.



## PATROL LIFELINE COMPONENTS

n.	CODE
1	PATROLEND / PATROLTERM
2	SPEAREVO / SPEAR
3	OHANGEXT + ANGSUP / OHANGINT + ANGSUP
4	OHINT
5	OHSLIDE
6	CABLE

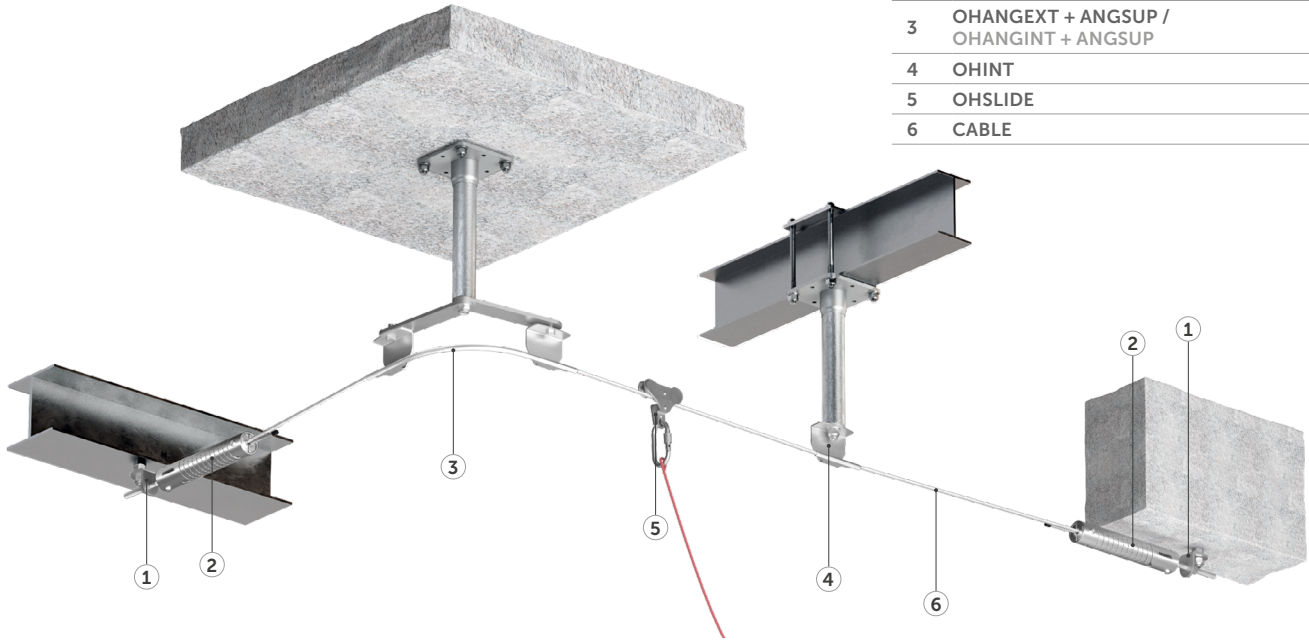

## TECHNICAL DATA\*

substructure	minimum thickness	fasteners
C20/25	140 mm	rod $\varnothing 12/\varnothing 16$ VIN-FIX HYB-FIX
S235JR	5 mm	EKS + ULS + MUT

		with SPEAR	with SPEAREVO <b>NEW</b>
minimum spacing	$X_{min}$ [m]	2	2
maximum spacing	$X_{max}$ [m]	7,5	15
maximum deflection	$Y_{max}$ [m]	1,30	3,35

\* The values indicated are the result of experimental tests carried out under the supervision of third parties in accordance with the standard referred to. For a calculation report with minimum distances according to the relevant standard requirements, the substructure must be checked by a qualified engineer before installation.

## PATROLEND | CODES AND DIMENSIONS

**A2**  
AISI 304

CODE	material	B	H	L	s	pcs	
		[mm]	[mm]	[mm]	[mm]		
PATROLEND	AISI 304 stainless steel grade 1.4301	40	61	66	6	1	
PATROLTERM	AISI 304 stainless steel grade 1.4301						

## COMPLEMENTARY PRODUCTS

CODE	description	page		CODE	description	page	
OHINT	pass-through intermediate element for aerial application	48		OHANGEXT	outside pass-through angle bracket for aerial application in A4	50	
OHANGINT	inside pass-through angle bracket for aerial application in A4	49		ANGSUP	support for PASANGBENDA4, OHANGINTA4 and OHANGEXTA4	50	

For TOWER codes see page 22.

# PATROL ON WALL



## WALL-MOUNTED LIFELINE ON STEEL AND CONCRETE



### AESTHETICS

The size of the components minimises the aesthetic impact of the safety device on the roof.



### FUNCTIONAL

Thanks to the different components available, it is possible to create life-lines according to site requirements.

### PRACTICAL

Possibility of using components that allow the operator to pass through intermediate points and curves by means of a sliding device.



LOAD DIRECTION



TYPES OF APPLICATION



VIDEO



MANUALS



▼ *PATROL lifeline installed on the wall directly on a steel or concrete support structure.*



## PATROL LIFELINE COMPONENTS

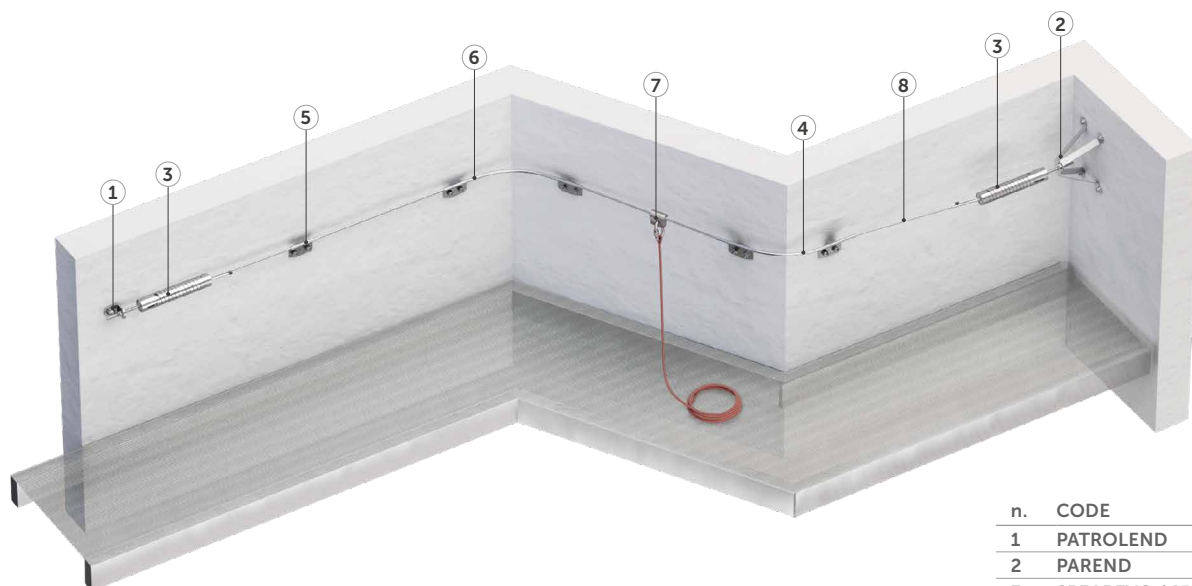

n.	CODE
1	PATROLEND
2	PAREND
3	SPEAREVO / SPEAR
4	PAREXBEND / PAREX
5	PARINTER
6	PARINBEND / PARIN
7	SLIDE 1 / SLIDE 2
8	CABLE

## TECHNICAL DATA\*

substructure	minimum thickness	fasteners
C20/25	140 mm	rod Ø12/Ø16 VIN-FIX HYB-FIX
S235JR	5 mm	EKS + ULS + MUT

		with SPEAR	with SPEAREVO <b>NEW</b>
minimum spacing	$X_{min}$ [m]	2	2
maximum spacing	$X_{max}$ [m]	7,5	15
maximum deflection	$Y_{max}$ [m]	1,30	3,35

\* The values indicated are the result of experimental tests carried out under the supervision of third parties in accordance with the standard referred to. For a calculation report with minimum distances according to the relevant standard requirements, the substructure must be checked by a qualified engineer before installation.

## PATROLEND | CODES AND DIMENSIONS

**A2**  
AISI 304

CODE	material	B [mm]	H [mm]	L [mm]	s [mm]	pcs	
PATROLEND	AISI 316 stainless steel grade 1.4401	40	61	66	6	1	
PAREND	AISI 304 stainless steel grade 1.4301	300	150	300	-	1	

## COMPLEMENTARY PRODUCTS

CODE	description	page	
PAREX	external pass through angle bracket for façades	49	
PARIN	internal pass through angle bracket for façades	50	
PARINTER	pass through intermediate element for façades	49	

CODE	description	page	
PARINBEND	internal pass-through angle bracket for façades adjustable 105°-165°	50	
PAREXBEND	external pass-through angle bracket for façades adjustable 105°-165°	50	

# PATROL A4

## LIFELINE WITH A4 STAINLESS STEEL COMPONENTS

A4  
AISI 316

EN  
795:2012 C

CEN/TS  
16415:2013

UNI  
11578:2015  
C



### STRONG

AISI 316 stainless steel elements provide excellent corrosion resistance in marine and industrial environments.



### USE

Specially designed shuttles can be used to enable the operator to pass through bends and intermediate points without ever disconnecting.

### ASSEMBLY

Quick and easy directly on concrete or steel structure.



LOAD DIRECTION



TYPES OF APPLICATION



VIDEO



MANUALS



▼ *PATROL lifeline installed with stainless steel supports on the deck of a ship.*



## PATROL A4 LIFELINE COMPONENTS

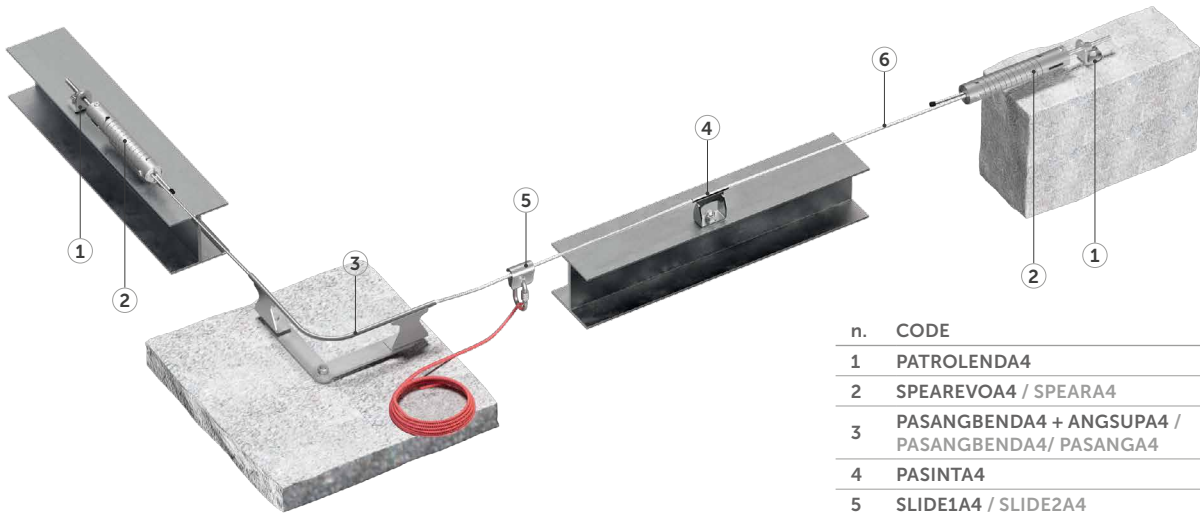

n.	CODE
1	PATROLENDA4
2	SPEAREVOA4 / SPEARA4
3	PASANGBENDA4 + ANGSUPA4 / PASANGBENDA4/ PASANGA4
4	PASINTA4
5	SLIDE1A4 / SLIDE2A4
6	CABLE

For technical data please refer to PATROL + PATROLEND on page 40.

## PATROL OVERHEAD A4 LIFELINE COMPONENTS

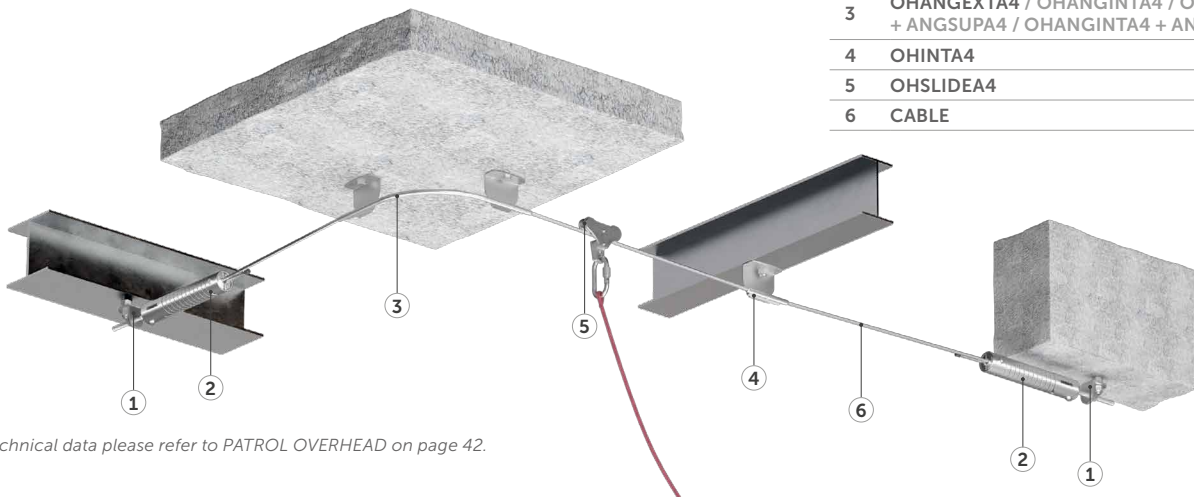

n.	CODE
1	PATROLENDA4
2	SPEAREVOA4 / SPEARA4
3	OHANGEXTA4 / OHANGINTA4 / OHANGEXTA4 + ANGSUPA4 / OHANGINTA4 + ANGSUPA4
4	OHINTA4
5	OHSLIDEA4
6	CABLE

For technical data please refer to PATROL OVERHEAD on page 42.

## PATROL ON WALL A4 LIFELINE COMPONENTS

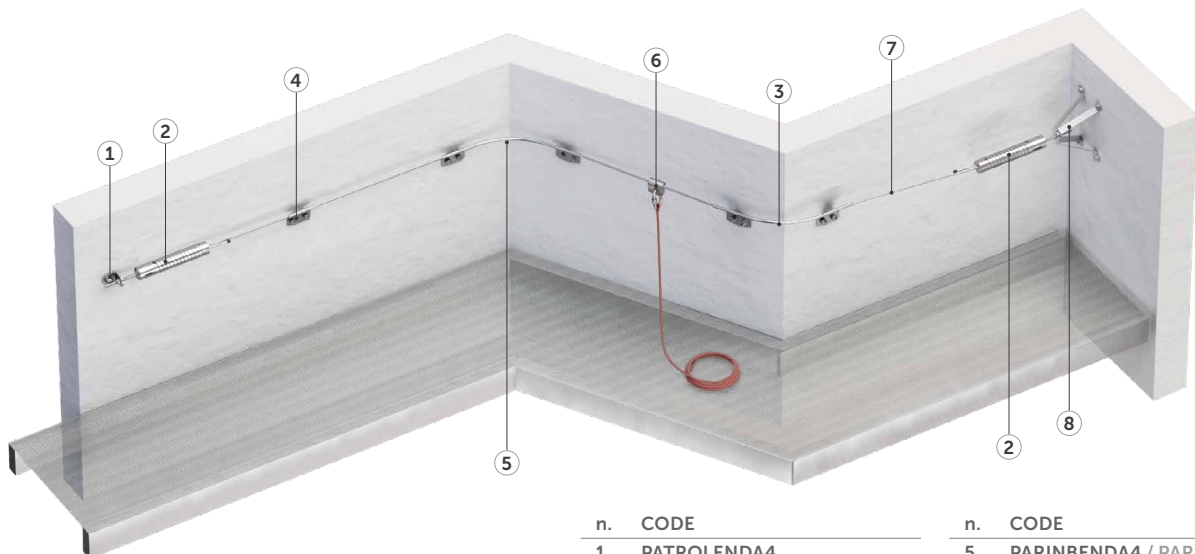

n.	CODE	n.	CODE
1	PATROLENDA4	5	PARINBENDA4 / PARINA4
2	SPEAREVOA4 / SPEARA4	6	SLIDE1A4 / SLIDE2A4
3	PAREXBENDA4 / PAREXA4	7	CABLE
4	PARINTERA4	8	PARENDA4

For technical data please refer to PATROL ON WALL on page 44.

## TERMINAL ELEMENTS | CODES AND DIMENSIONS

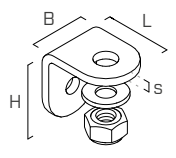
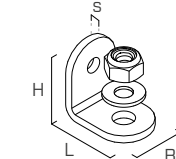
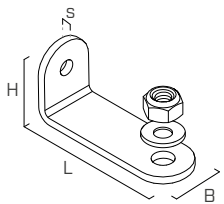
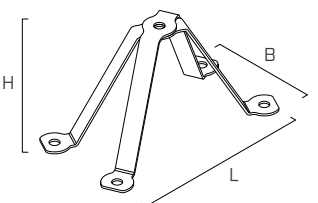

CODE	description	material	B [mm]	H [mm]	L [mm]	s [mm]	pcs	
PATROLTERM	terminal element	AISI 304 stainless steel grade 1.4301	40	61	66	6	1	
PATROLEND	terminal element	AISI 304 stainless steel grade 1.4301	40	61	66	6	1	
PATROLEND4	A4 stainless steel terminal element	AISI 316 stainless steel grade 1.4401						
PATROLTERML	long terminal	AISI 304 stainless steel grade 1.4301	40	61	180	6	1	
PAREND	terminal element with 4 feet per side	AISI 304 stainless steel grade 1.4301	300	150	300	-	1	
PAREND4	terminal element with 4 feet per façade made of A4 stainless steel	AISI 316 stainless steel grade 1.4401						

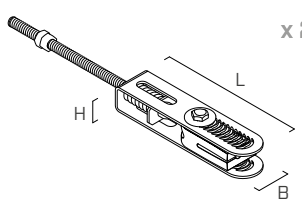
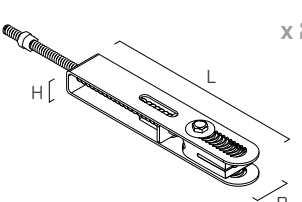
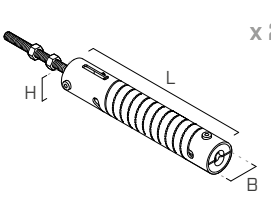
## TENSIONERS AND ENERGY ABSORBERS | CODES AND DIMENSIONS



CODE	description	material	B [mm]	H [mm]	L [mm]	s [mm]	pcs	
SPEAR	set of pair of tensioners with absorber	AISI 304 stainless steel grade 1.4301 EN AW 6082 aluminium	63	50	380	-	1	 x 2
SPEAR4	set of pair of tensioners with A4 absorber	AISI 316 stainless steel grade 1.4401 EN AW 6082 aluminium						
SPEAR2	set of pair of tensioners with absorber for standing seam roofs	AISI 304 stainless steel grade 1.4301 EN AW 6082 aluminium	63	50	472	-	1	 x 2
SPEAREVO	set of pair of tensioners with absorber	AISI 304 stainless steel grade 1.4301	50	50	291	-	1	 x 2
SPEAREVOA4	set of pair of tensioners with A4 absorber	AISI 316 stainless steel grade 1.4401						

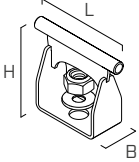
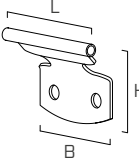
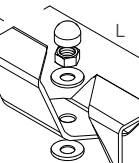
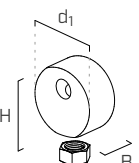
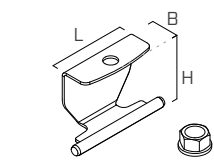

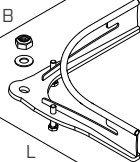
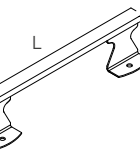
## INTERMEDIATE ELEMENTS | CODES AND DIMENSIONS

CODE	description	material	d <sub>1</sub> [mm]	B [mm]	H [mm]	L [mm]	s [mm]	pcs	
PASINT	pass-through intermediate element	AISI 304 stainless steel grade 1.4301	-	35	86	100	-	1	
PASINTA4	pass-through intermediate element INOX A4	AISI 316 stainless steel grade 1.4401	-	35	86	100	-	1	
PARINTER	pass through intermediate element for façades	AISI 304 stainless steel grade 1.4301	-	100	88	120	-	1	
PARINTERA4	A4 stainless steel pass through intermediate element for façades	AISI 316 stainless steel grade 1.4401	-	100	88	120	-	1	
PATROLINT	semi-pass-through intermediate element	AISI 304 stainless steel grade 1.4301	-	50	50	375	5	1	
PATROLMED	non-pass-through intermediate element	AISI 304 stainless steel grade 1.4301 EN AW 6082 aluminium	55	30	50	-	-	1	
OHINT	pass-through intermediate element for aerial application	AISI 304 stainless steel grade 1.4301	-	40	86	130	-	1	
OHINTA4	pass-through intermediate element for aerial application in A4	AISI 316 stainless steel grade 1.4401	-	40	86	130	-	1	

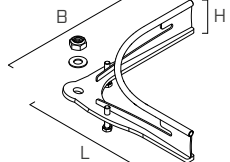
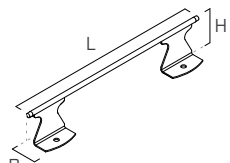
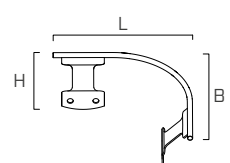
## ANGLE BRACKETS | CODES AND DIMENSIONS

CODE	description	material	d <sub>1</sub> [mm]	B [mm]	H [mm]	L [mm]	pcs	
PASANG	corner pass-through element	AISI 304 stainless steel grade 1.4301	-	300	69	300	1	
PASANGA4	A4 stainless steel pass through angle bracket	AISI 316 stainless steel grade 1.4401	-	300	69	300	1	
PASANGBEND	pass-through angle bracket for adjustable supports 105°-165°	AISI 304 stainless steel grade 1.4301	-	54,5	102	565	1	
PASANGBENDA4	pass-through angle bracket for adjustable A4 supports 105°-165°	AISI 316 stainless steel grade 1.4401	-	54,5	102	565	1	
PAREX	external pass through angle bracket for façades	AISI 304 stainless steel grade 1.4301	-	326	117	326	1	
PAREXA4	external pass through angle bracket for A4 façades	AISI 316 stainless steel grade 1.4401	-	326	117	326	1	

## ANGLE BRACKETS | CODES AND DIMENSIONS

CODE	description	material	d <sub>1</sub> [mm]	B [mm]	H [mm]	L [mm]	pcs	
PAREXBEND	external pass-through angle bracket for façades adjustable 105°-165°	AISI 304 stainless steel grade 1.4301	-	72	116	565	1	
PAREXBENDA4	external pass-through angle bracket for A4 façades adjustable 105°-165°	AISI 316 stainless steel grade 1.4401	-	72	116	565	1	
PARIN	internal pass through angle bracket for façades	AISI 304 stainless steel grade 1.4301	-	357	88	357	1	
PARINA4	internal pass through angle bracket for A4 façades	AISI 316 stainless steel grade 1.4401	-	357	88	357	1	
PARINBEND	internal pass-through angle bracket for façades adjustable 105°-165°	AISI 304 stainless steel grade 1.4301	-	42	87	565	1	
PARINBENDA4	internal pass-through angle bracket for A4 façades adjustable 105°-165°	AISI 316 stainless steel grade 1.4401	-	42	87	565	1	
PATROLANG	non-pass-through angle bracket	AISI 304 stainless steel grade 1.4301 EN AW 6082 aluminium	90	-	58	175	1	
OHANGINT	internal pass through angle bracket for overhead application	AISI 304 stainless steel grade 1.4301	-	354	86	354	1	
OHANGINTA4	inside pass-through angle bracket for aerial application in A4	AISI 316 stainless steel grade 1.4401	-	354	86	354	1	
OHANGEXT	external pass-through angle bracket for overhead application	AISI 304 stainless steel grade 1.4301	-	326	86	326	1	
OHANGEXTA4	outside pass-through angle bracket for aerial application in A4	AISI 316 stainless steel grade 1.4401	-	326	86	326	1	
BENDTOOL	adjustable angle bracket bending tool	S235JR zinc plated steel	-	199	435	200	1	
ANGSUP	support for PASANGBEND, OHANGINT and OHANGEXT	AISI 304 stainless steel grade 1.4301	-	275	16	0 - 550	1	
ANGSUPA4	support for PASANGBENDA4, OHANGINTA4 and OHANGEXTA4	AISI 316 stainless steel grade 1.4401	-	275	16	0 - 550	1	

## SLIDING DEVICES | CODES AND DIMENSIONS

CODE	description	material	d <sub>1</sub> [mm]	B [mm]	H [mm]	L [mm]	pcs	
SLIDE1	removable sliding device	AISI 304 stainless steel grade 1.4301	-	30	60	60	1	
SLIDE1A4	removable A4 sliding device	AISI 316 stainless steel grade 1.4401	-	30	60	60	1	
SLIDE2	fixed sliding device	AISI 304 stainless steel grade 1.4301	-	30	60	60	1	
SLIDE2A4	fixed A4 sliding device	AISI 316 stainless steel grade 1.4401	-	30	60	60	1	
OHSLIDE	removable sliding device for overhead lifeline	AISI 304 stainless steel grade 1.4301	-	120	30	102	1	
OHSLIDEA4	removable sliding device for overhead A4 lifeline	AISI 316 stainless steel grade 1.4401	-	120	30	102	1	

## ROPE | CODES AND DIMENSIONS

CODE	description	material	pcs
CABLE	stainless steel rope Ø8 7x7	AISI 316 stainless steel grade 1.4401	1



## INFORMATION PLATES AND ACCESSORIES | CODES AND DIMENSIONS

CODE	description	pcs
TARGA	system information plate	1
TARGAST11	additional adhesive for TARGA: PL-SK-CZ-HU-RO	1
TARGAST12	additional adhesive for TARGA: NL-SV-NO-FI-RU	1
PATROLSTOP	limit switch element	1

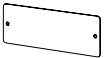

## PATROLKIT10 | 10 m LIFELINE KIT

CODE	description	material	
PATROLKIT10	PATROLTERM	terminal element	AISI 304 stainless steel grade 1.4301
	SPEAR	set of pair of tensioners with absorber	AISI 304 stainless steel grade 1.4301 EN AW 6082 aluminium
	CABLE	stainless steel rope Ø8 7x7 11 m	AISI 316 stainless steel grade 1.4401

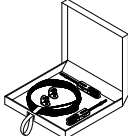

Also includes a 22 kN webbing length 0.4 m EN 795/B EN 566 - EN 354.

## PATROLKIT15 | 15 m LIFELINE KIT

CODE	description	material	
PATROLKIT15	PATROLTERM	terminal element	AISI 304 stainless steel grade 1.4301
	SPEAR	set of pair of tensioners with absorber	AISI 304 stainless steel grade 1.4301 EN AW 6082 aluminium
	CABLE	stainless steel rope Ø8 7x7 16 m	AISI 304 stainless steel grade 1.4301



Also includes a 22 kN webbing length 0.4 m EN 795/B EN 566 - EN 354.

## PATROLKIT30 | 30 m LIFELINE KIT

CODE	description	material	
PATROLKIT30	PATROLTERM	terminal element	AISI 304 stainless steel grade 1.4301
	SPEAR	set of pair of tensioners with absorber	AISI 304 stainless steel grade 1.4301 EN AW 6082 aluminium
	PATROLMED	non-pass-through intermediate element	AISI 304 stainless steel grade 1.4301 EN AW 6082 aluminium
	CABLE	stainless steel rope Ø8 7x7 31 m	AISI 316 stainless steel grade 1.4401



Also includes a 22 kN webbing length 0.4 m EN 795/B EN 566 - EN 354.

# PATROL | tensioners with absorber



**SPEAR**  
Pair of tensioners with absorber.



**SPEAR2**  
Pair of tensioners with absorber for lifeline on double and round seam.

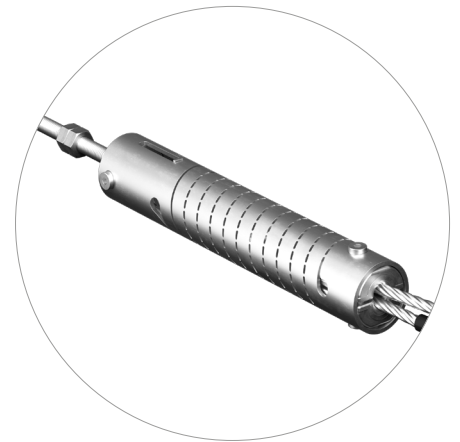

**SPEAREVO**  
Pair of tensioners with absorber. It further reduces the strain on the terminals.

characteristics	SPEAR	SPEAR 2	SPEAR EVO
complete set for both terminals	●	●	●
few components	●	●	●
compact	●	-	●
installation in just a few steps	●	●	●
installation with standard tools	●	●	●
adjustable during assembly	●	●	●
indication of pretension	●	●	●
easy to inspect	●	●	●
entirely made of stainless steel	-	-	●
rope closing with self-locking function	-	-	●
designed and tested to further reduce strain on terminals	-	-	●
designed and tested to increase the distance between supports	-	-	●
designed and tested to increase the number of users	-	-	●
compatible supports	TOWER, TOWERA2, TOWERXL, PATROLEND, PAREND, SHIELD, COPPO, TWIST	SIANK4, SEAMO	BLOCK, SHIELD, PATROLEND, PAREND

# PATROL | intermediate - angle brackets

## PRODUCTS WITH FIXED GEOMETRY



PARINTER



PARIN/PAREX



PASANG



PASINT

## FLEXIBLE / ADAPTABLE "BEND" PRODUCTS



### PARINBEND/PAREXBEND

Internal/external pass through angle bracket for façades. An angle of 165°-105° can be adjusted using the BENDTOOL.



### PASANGBEND

Adjustable pass-through angle bracket for direct installation. An angle of 165°-105° can be adjusted using the BENDTOOL.



### PASANGBEND + ANGSUP

Adjustable pass-through angle bracket for supports. An angle of 165°-105° can be adjusted using the BENDTOOL.

## BENDTOOL

Tool for adjusting the angle of PARINBEND/PAREXBEND/PASANGBEND devices between 165° and 105°.

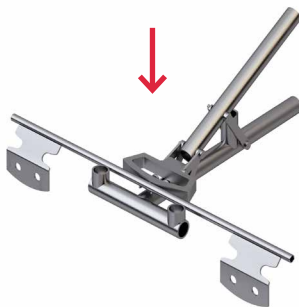

1. Insert the selected bendable angle element into the BENDTOOL bending device.



2. Bend the angle element by levering with the bending device.

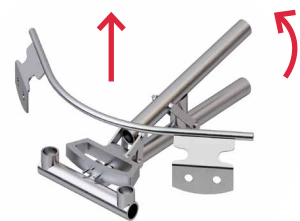

3. Remove the angle element from the bending device. The element is ready to be installed.

# VERTIGRIP

## VERTICAL LIFELINE

### SIMPLE, MODULAR, DURABLE.

The VERTIGRIP vertical lifeline is the ideal system for ensuring safety on ladders and vertical accesses.

Fast and easy to assemble, installation only takes a few steps. Modular system that can meet any design requirement thanks to the wide range of available accessories offering greater versatility of use. Complete system in AISI 316 stainless steel - AISI 304 stainless steel - EN AW 6082 aluminium alloy, guarantees good corrosion resistance.

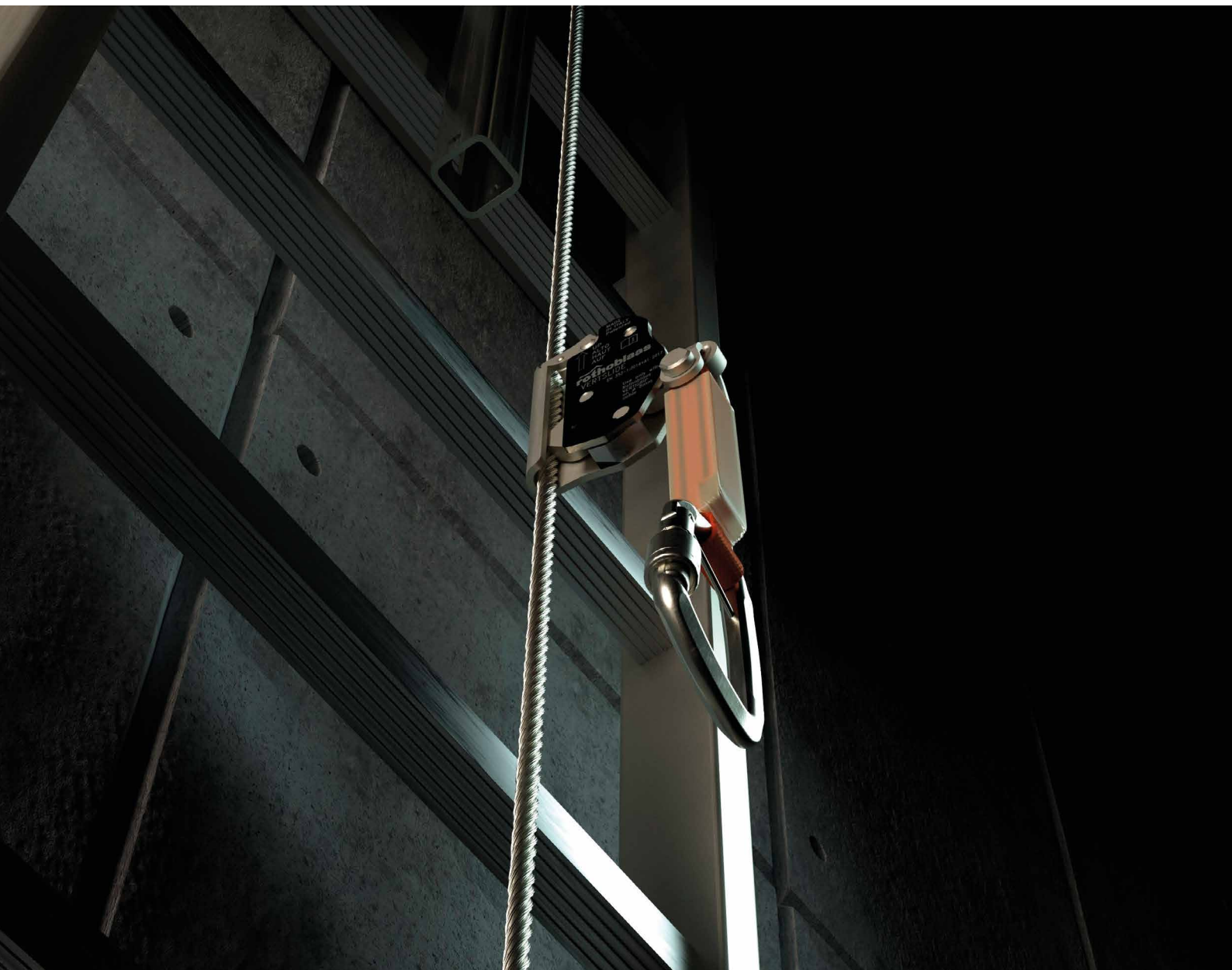
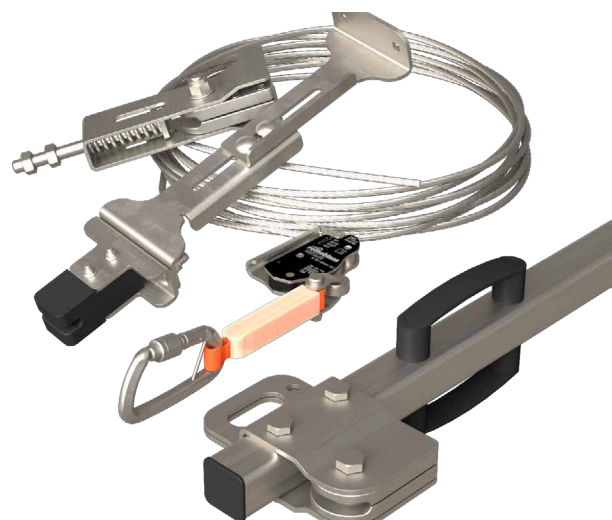

## VERTIGRIP ON LADDER

VERTICAL LIFELINE ON LADDERS



▶ PAGE 56



## VERTIGRIP ON WALL

VERTICAL LIFELINE ON WALL



▶ PAGE 58



## VERTIGRIP A4

VERTICAL LIFELINE WITH A4 STAINLESS STEEL ELEMENTS



▶ PAGE 60



# VERTIGRIP ON LADDER

## VERTICAL LIFELINE ON LADDERS

CE EAC

EN  
353-1:2014  
+ A1:2017  

RFU 11.119

### QUALITY

Complete system in AISI 316 stainless steel - AISI 304 stainless steel  
EN AW 6082 aluminium alloy, guarantees excellent corrosion resistance.



### TOTAL CONTROL

Guided type fall arrester on rope with integrated energy absorber, which allows a controlled ascent and descent in safe conditions.

### PRACTICAL

The system can be assembled off-centre on the ladder.

▼ Installation of a VERTIGRIP vertical lifeline on a ladder for maintenance of an automated warehouse.



VIDEO



MANUALS

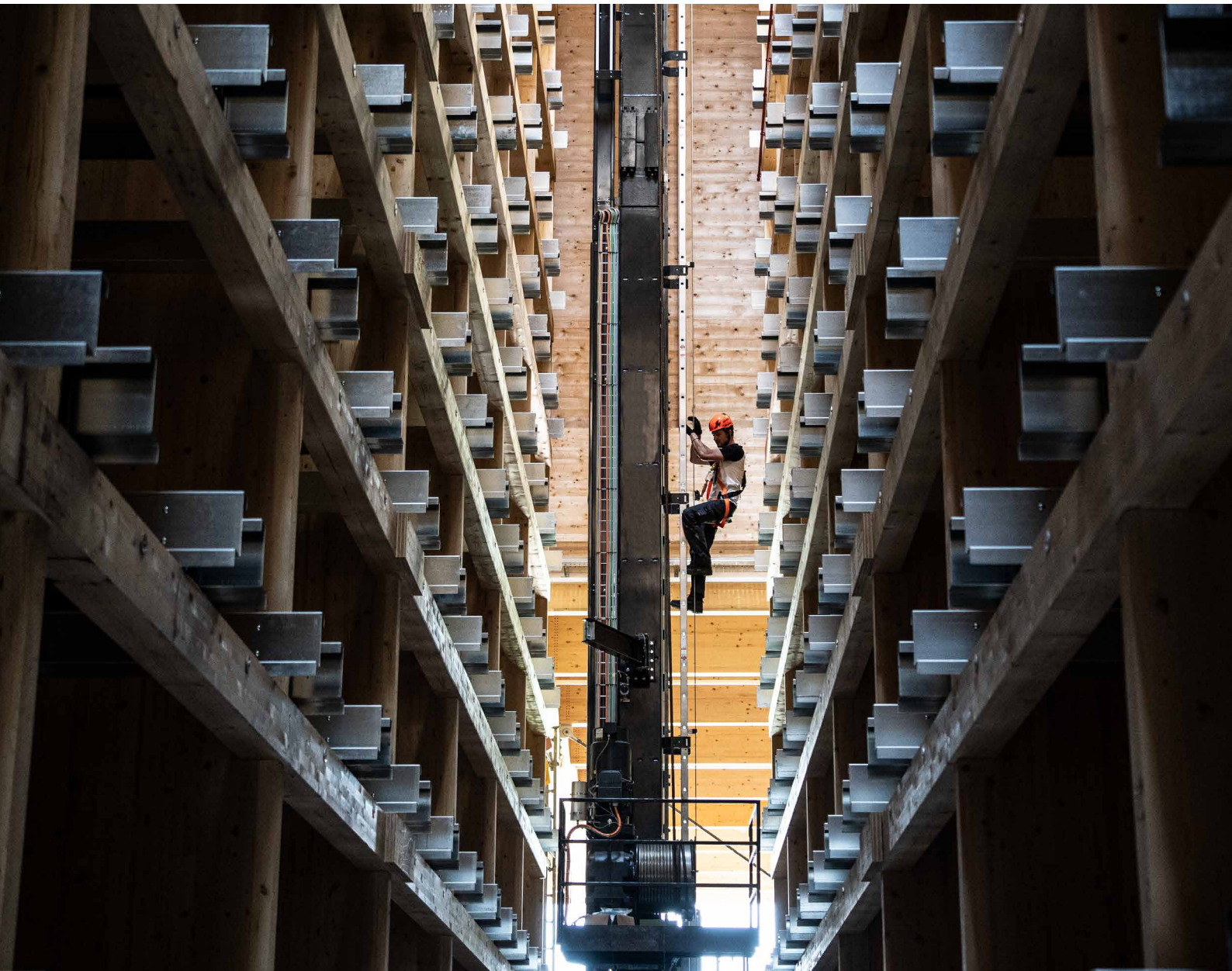



## VERTICAL LIFELINE COMPONENTS

n.	CODE
1	VERTBASE
2	VERTSPEAR
3	VERTHAND
4	VERTSUP
5	CABLE
6	VERTINTPAS1 / VERTINTPAS2 / VERTINT
7	VERTSLIDEPAS / VERTSLIDE
8	VERTOP17 / VERTOP09

## TECHNICAL DATA\*

A2  
AISI 304

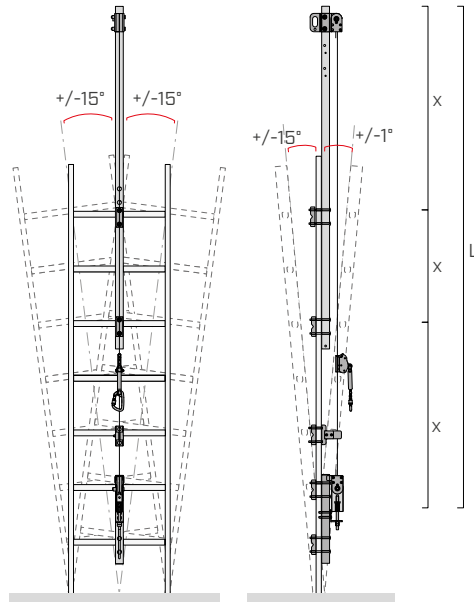

L = max 200 m  
x = max 5 m

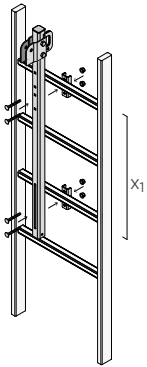

$450 \text{ mm} \leq x_1 \leq 700 \text{ mm}$

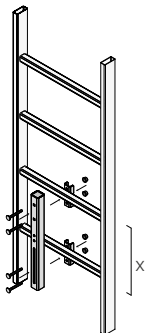

$225 \text{ mm} \leq x \leq 350 \text{ mm}$

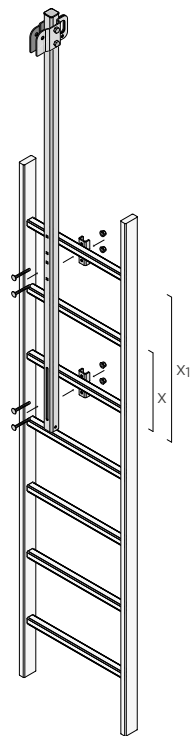

$450 \text{ mm} \leq x_1 \leq 700 \text{ mm}$   
 $225 \text{ mm} \leq x \leq 350 \text{ mm}$

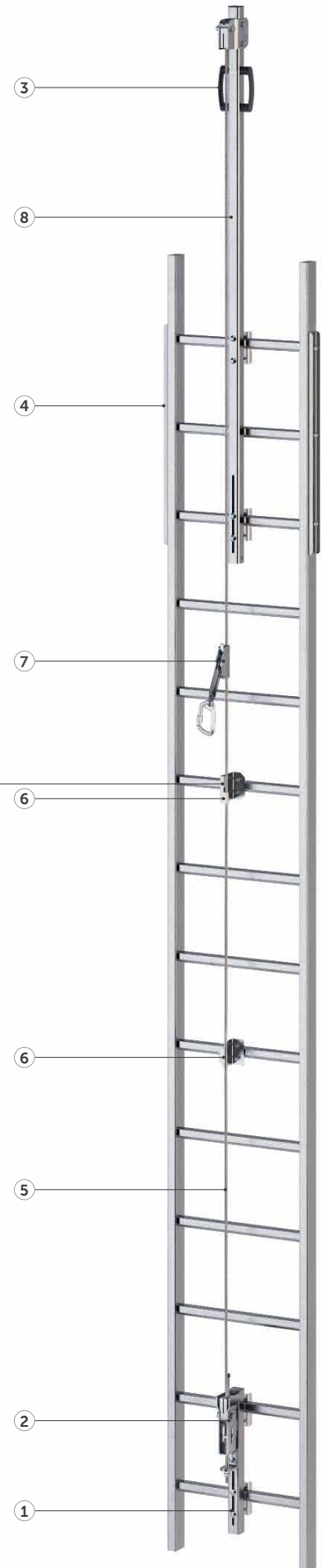

\* The values indicated are the result of experimental tests carried out under the supervision of third parties in accordance with the standard referred to. For a calculation report with minimum distances according to the relevant standard requirements, the substructure must be checked by a qualified engineer before installation.

# VERTIGRIP ON WALL

## VERTICAL LIFELINE ON WALL

A2  
AISI 304

CE

EN  
353-1:2014  
+ A1:2017

RFU 11.119

### ALTERNATIVE

Alternative solution when it is not possible to assemble the vertical lifeline on the ladder.



### ADJUSTABLE

Possibility of adjusting the distance of the lifeline from the wall.

### FUNCTIONAL

It can be installed on walls inclined at an angle of up to 15° from the vertical.

▼ Installation of VERTIGRIP vertical lifeline on a ladder for maintenance of a high voltage tower.



## VERTICAL LIFELINE COMPONENTS

n.	CODE
1	VERTBASEW
2	VERTSPEAR
3	CABLE
4	VERTINTPAS1 / VERTINTPAS1 / VERTINTPAS2
5	VERTSLIDEPAS / VERTSLIDE
6	VERTOPW
7	VERTINTPAS1 / VERTINTPAS2 / VERTINT

## TECHNICAL DATA\*

substructure	minimum thickness	fasteners
 CLT	200 mm	VGS Ø9 
 C20/25	140 mm	AB1 Ø12 
		rod Ø12 
		VIN-FIX HYB-FIX 
 S235JR	6 mm	EKS + ULS + MUT 

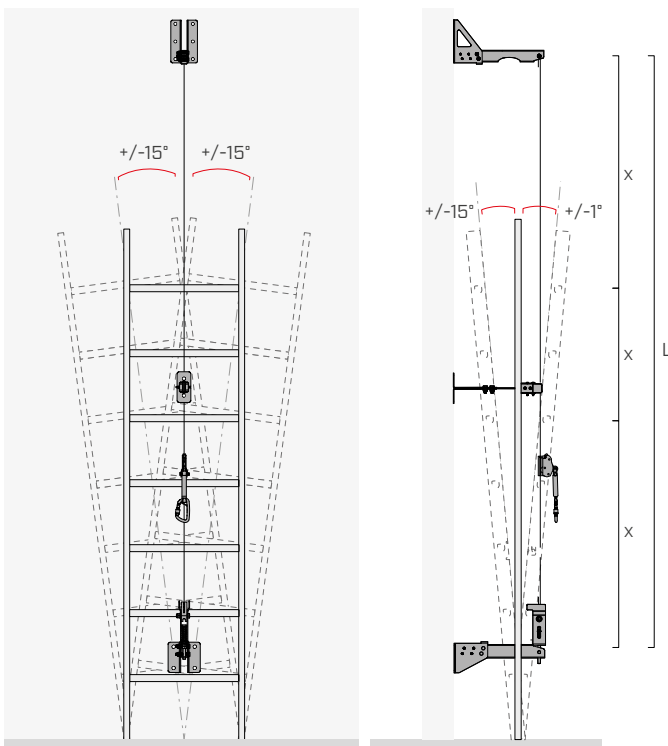

L = max 200 m

x = max 5 m

\* The values indicated are derived from experimental tests carried out under the supervision of third party organisations according to the referenced standard. For a calculation report with minimum distances, according to the referenced normative requirements, the substructure must be verified by a qualified engineer before installation.

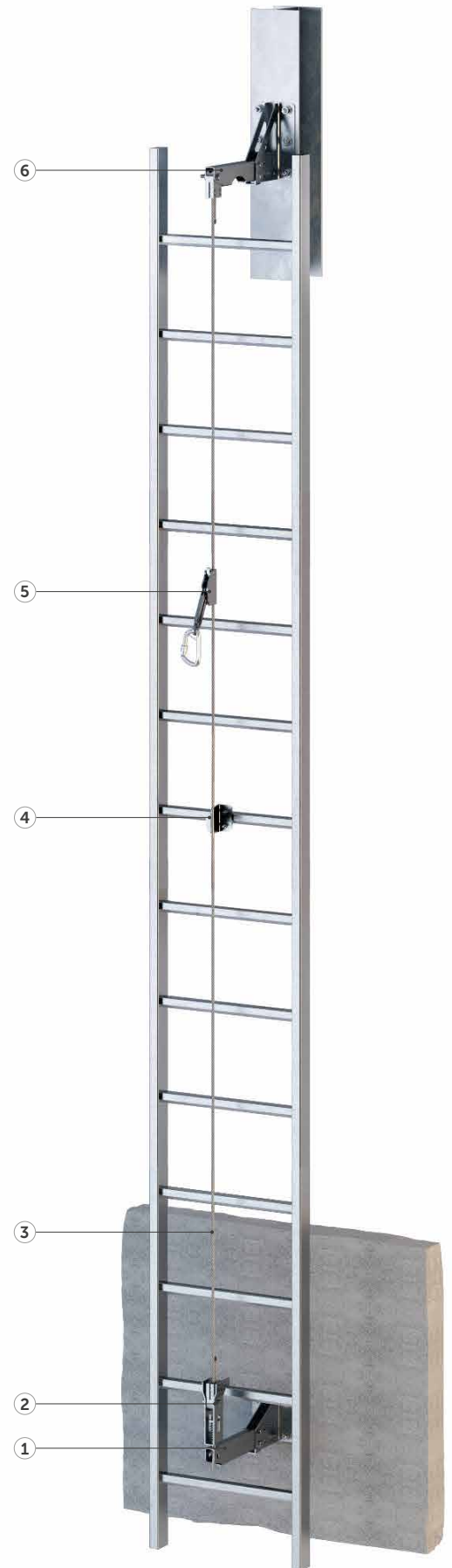

# VERTIGRIP A4

A4  
AISI 316

CE

## VERTICAL LIFELINE WITH A4 STAINLESS STEEL ELEMENTS

EN  
353-1:2014  
+ A1:2017  

RFU 11.119

### STRONG

AISI 316 stainless steel elements provide excellent corrosion resistance in marine and industrial environments.



### TOTAL CONTROL

Guided type fall arrester on rope with integrated energy absorber, which allows a controlled ascent and descent in safe conditions.

### FUNCTIONAL

It can be installed on walls inclined at an angle of up to 15° from the vertical.

▼ Installation of VERTIGRIP A4 vertical lifeline on a ladder for maintenance of an offshore installation.

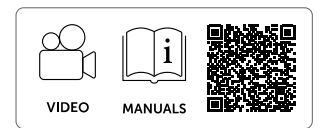

## VERTICAL LIFELINE COMPONENTS

n. CODE

1 VERTBASEA4

2 VERTSPEARA4

3 VERTINTPAS1A4 / VERTINTA4 /  
VERTINTPAS2A4

4 VERTSLIDEPAS / VERTSLIDE

5 VERTOP09A4

6 CABLE

### TECHNICAL DATA

For technical data, please refer to the VERTIGRIP ON LADDER page 56.

n. CODE

1a VERTBASEWA4

2a VERTSPEARA4

3a VERTINTPAS1A4 / VERTINTPAS2A4  
VERTINTA4 / VERTINTWA4

4a VERTOPWA4

5a VERTSLIDEPAS / VERTSLIDE

6a CABLE

### TECHNICAL DATA

For technical data, please refer to the VERTIGRIP ON WALL page 58.

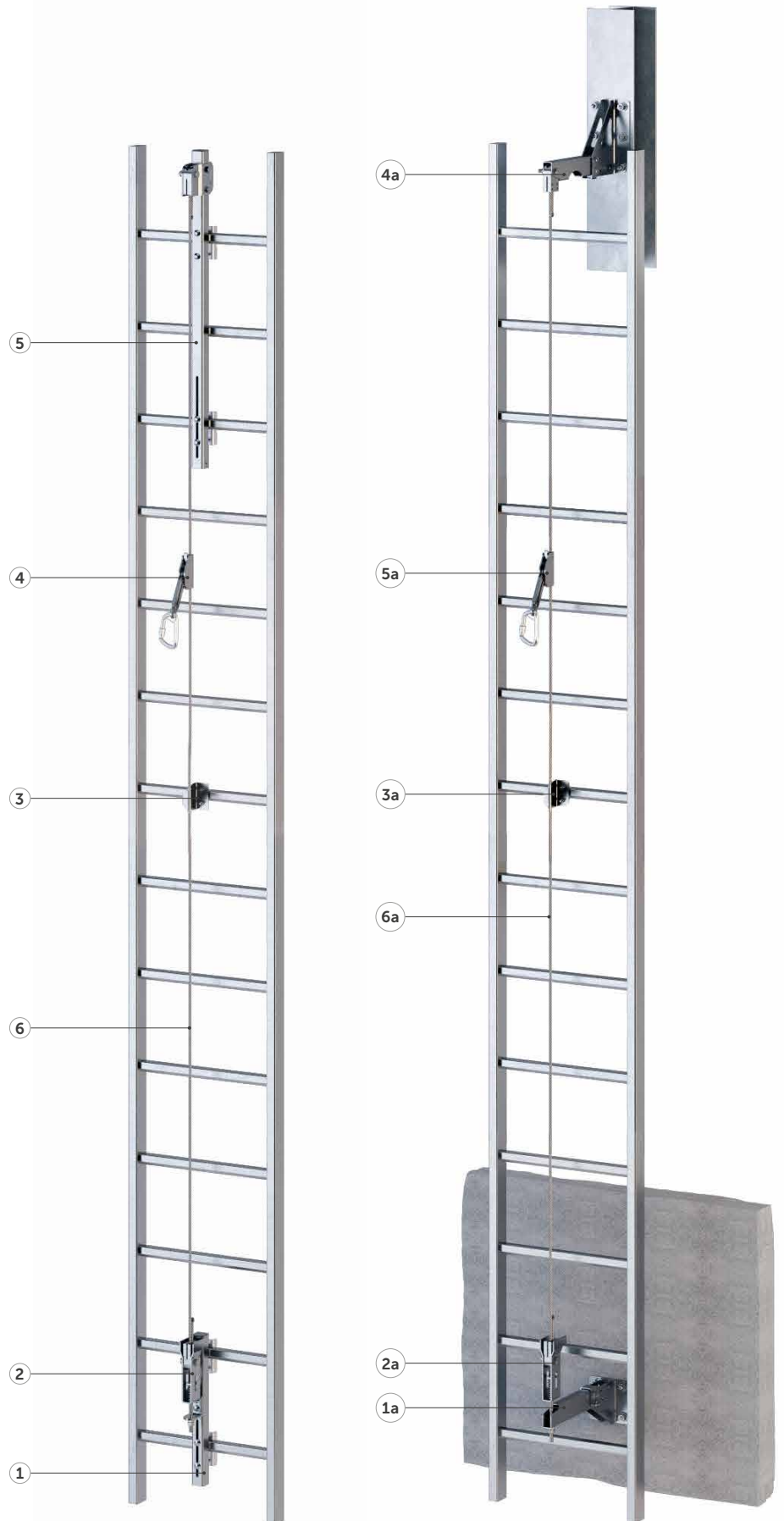



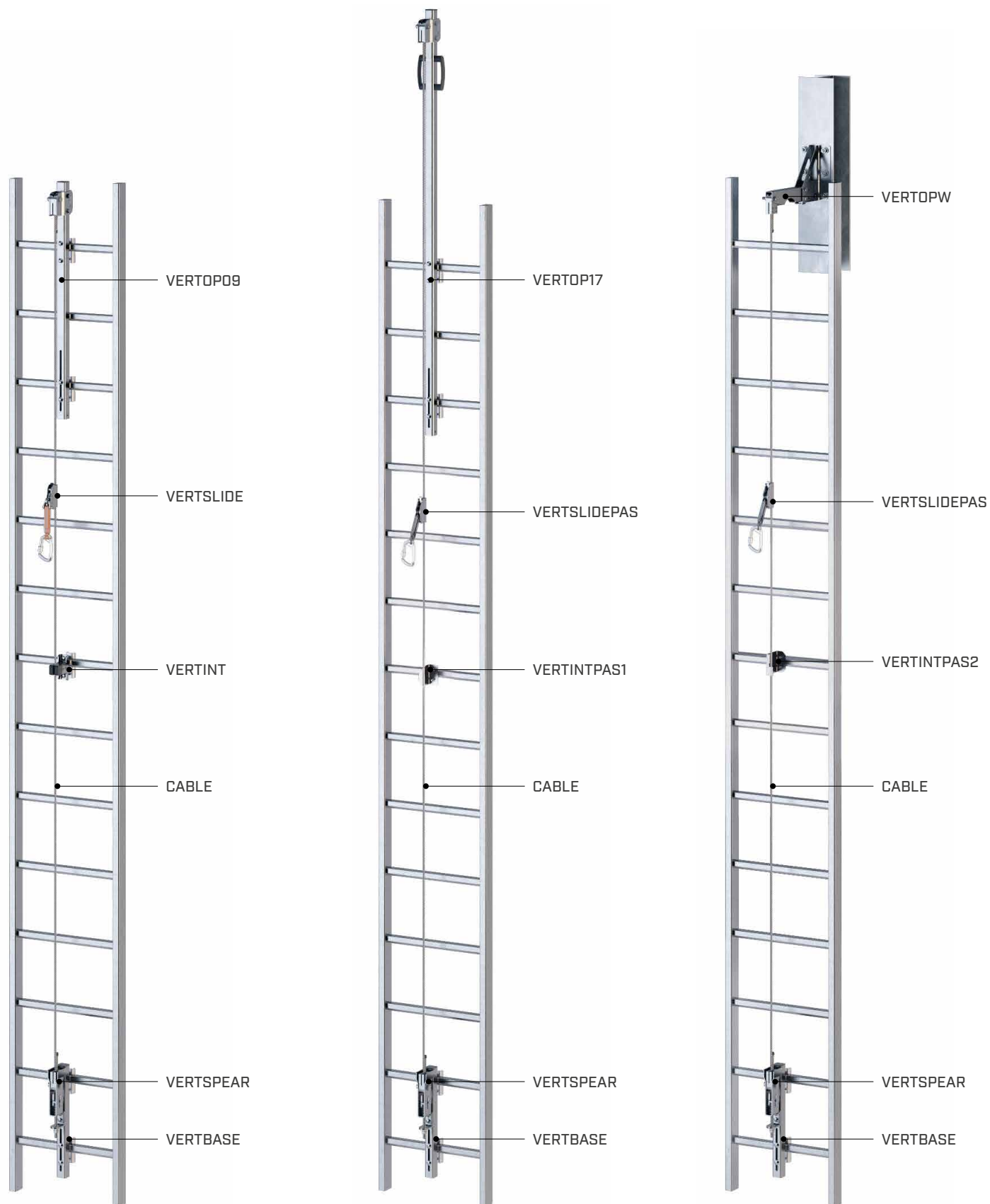

# VERTIGRIP | combinations



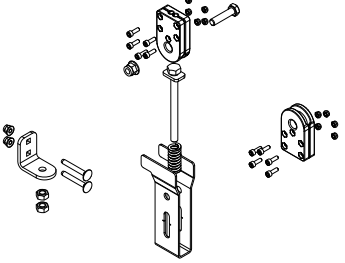

# VERTIGRIP | components

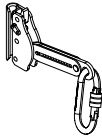
## MAIN COMPONENTS OF THE VERTICAL LIFELINE

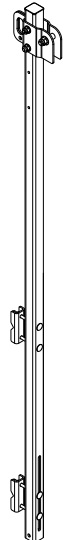
GROUP	CODE	description	material	weight [kg]	pcs	
TENSIONER	VERTSPEAR	set for vertical lifeline with clamps and tensioner	stainless steel 1.4301 / AISI 304 EN AW 6082 aluminium	2,60	1	
	VERTSPEARA4	set for vertical lifeline with A4 clamps and tensioner	AISI 316 stainless steel grade 1.4401			
ROPE	CABLE	stainless steel rope AISI 316 Ø8 mm 7x7	AISI 316 stainless steel	0,259	1	
GUIDED TYPE FALL ARRESTER	VERTSLIDE	removable guided type fall arrester with energy absorber for vertical lifeline	AISI 304 stainless steel grade 1.4301 EN AW 7075 T6 aluminium	0,465	1	
	VERTSLIDEPAS	removable sliding through fall arrest device with energy absorber for vertical lifeline	AISI 304 stainless steel grade 1.4301	0,67	1	
UPPER ANCHOR SYSTEM	VERTOP09	upper anchor system (0,9 m) for vertical lifeline on ladder	AISI 304 stainless steel grade 1.4301	4,44	1	
	VERTOP09A4	upper anchor system (0,9 m) for vertical lifeline on A4 ladder	AISI 316 stainless steel grade 1.4401			
	VERTOP17	upper anchor system (1,7 m) for vertical lifeline on ladder	AISI 304 stainless steel grade 1.4301	9,46	1	
	VERTOP17A4	upper anchor system (1,7 m) for vertical lifeline on A4 ladder	AISI 316 stainless steel grade 1.4401			



GROUP	CODE	description	material	weight	pcs	
				[kg]		
LOWER ANCHOR SYSTEM	VERTBASE	lower anchor system for vertical lifeline on ladder	AISI 304 stainless steel grade 1.4301	1,84	1	
	VERTBASEA4	lower anchor system for vertical lifeline on A4 ladder	AISI 316 stainless steel grade 1.4401			
INTERMEDIATE BRACKET*	VERTINT	intermediate bracket for vertical lifeline on ladder	AISI 304 stainless steel grade 1.4301 - ABS	0,64	1	
	VERTINTA4	intermediate anchor system for vertical lifeline on A4 ladder	AISI 316 stainless steel grade 1.4401 - ABS			
	VERTINTPAS1	fixed pass-through intermediate for vertical lifeline	AISI 304 stainless steel grade 1.4301	0,126	1	
	VERTINTPAS1A4	fixed pass-through intermediate element for vertical A4 lifeline	AISI 316 stainless steel grade 1.4401			
	VERTINTPAS2	removable pass-through intermediate element for vertical lifeline	AISI 304 stainless steel grade 1.4301	0,155	1	
	VERTINTPAS2A4	removable pass-through intermediate element for vertical A4 lifeline	AISI 316 stainless steel grade 1.4401			

\*Recommended every 5 meters.

## SUPPORT FOR VERTICAL LIFELINE ON STRUCTURE

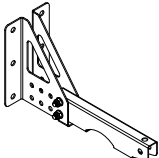
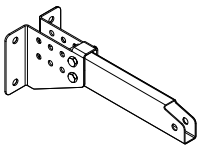
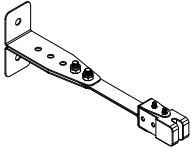
GROUP	CODE	description	material	weight	pcs	
				[kg]		
UPPER ANCHOR SYSTEM	VERTOPW	upper anchor system for vertical lifeline on structure	stainless steel 1.4301 / AISI 304	5,17	1	
	VERTOPWA4	upper anchor system for vertical lifeline on A4 structure	AISI 316 stainless steel grade 1.4401			
LOWER ANCHOR SYSTEM	VERTBASEW	lower anchor system for vertical lifeline on structure	stainless steel 1.4301 / AISI 304	4,52	1	
	VERTBASEWA4	lower anchor system for vertical lifeline on A4 structure	AISI 316 stainless steel grade 1.4401			
INTERMEDIATE BRACKET*	VERTINTW	intermediate bracket for vertical lifeline on structure	stainless steel 1.4301 / AISI 304 - ABS	1,52	1	
	VERTINTWA4	intermediate anchor system for vertical lifeline on A4 structure	AISI 316 stainless steel grade 1.4401 - ABS			

\*Recommended every 5 meters.

## VERTICAL LIFELINE ACCESSORIES

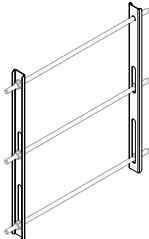
GROUP	CODE	description	material	weight [kg]	pcs	
HANDLE	VERTHAND	set of handles for VERTOP17	PA6 - stainless steel 1.4301 / AISI 304	0,14	1	
LADDER REINFORCE- MENT	VERTSUP1	additional reinforcement set for ladder*	stainless steel 1.4301 / AISI 304	1,48	1	

\*Threaded bars, nuts and washers not included in the set.

## INFORMATION PLATE

CODE	description	pcs
TARGA	system information plate: IT-EN-DE-ES-FR	1
TARGASTI1	additional adhesive for TARGA: PL-SK-CZ-HU-RO	1
TARGASTI2	additional adhesive for TARGA: NL-SV-NO-FI-RU	1

# VERTIGRIP | sliding devices



## VERTSLIDE

Removable guided type fall arrester with energy absorber for vertical lifeline.



## VERTSLIDEPAS

Removable sliding through fall arrest device with energy absorber for vertical lifeline.

technical features		VERTSLIDE	VERTSLIDEPAS
standard		EN 353-1:2014 + A1:2017	EN 353-1:2014 + A1:2017
absorber		fabric	stainless steel
types		semi - pass-through	through
cable diameter	[mm]	8	8
dimensions	[mm]	150 x 80 x 25	150 x 80 x 25
weight	[g]	200	300
type of closure		double block	triple block

## VERTIGRIP | ELEMENTS AND INTERMEDIATE ELEMENTS



### VERTINTPAS1

Fixed pass-through intermediate element for vertical lifeline.

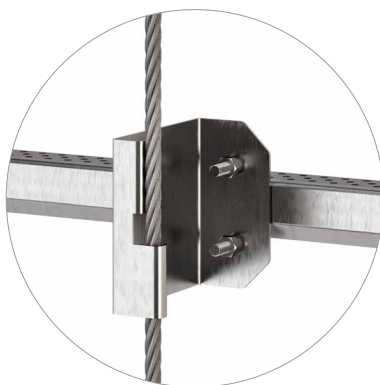

### VERTINTPAS2

Removable intermediate element for vertical lifeline.



### VERTINT

Intermediate bracket for vertical lifeline on ladder.

# RAIL SYSTEM OVERVIEW

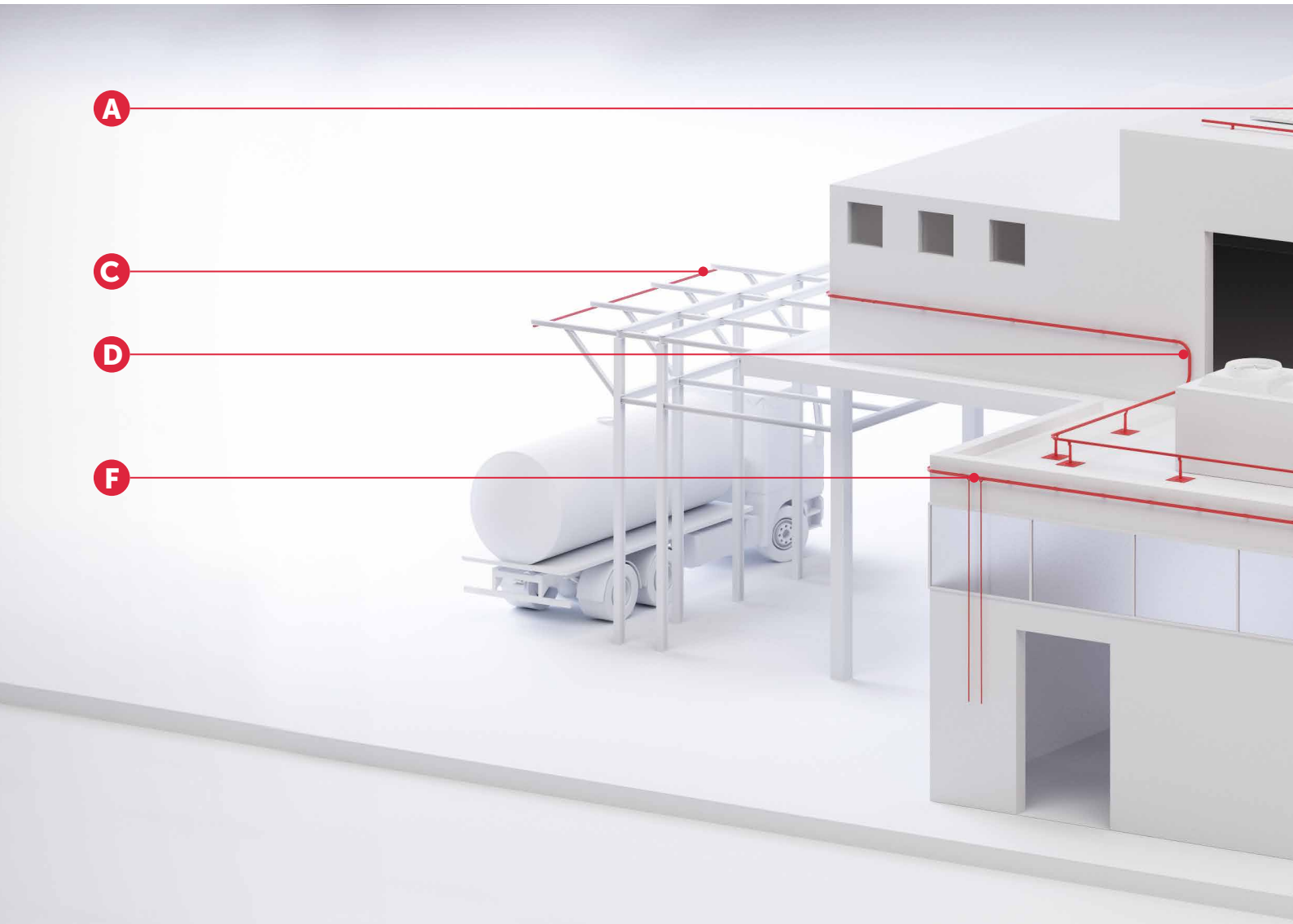

## **A** H-RAIL ON FLOOR

Rigid pass-through LIFELINE for horizontal use for direct application with or without metal brackets on different types of substructure. The accessories allow the rigid LIFELINE to be conformed to the structure on which it is assembled.  
Possible use of detachable sliding device along the whole system.

## **B** H-RAIL + TOWER

Rigid pass-through LIFELINE for horizontal use with TOWER bracket application, for assembly on various types of substructure. Ideal for elevated installation for overcoming obstacles.

## **C** H-RAIL OVERHEAD

Rigid pass-through LIFELINE for direct application with or without metal brackets on different types of substructure. Ideal for carrying out operations in special conditions, such as working on tanks, tankers, unsafe walkways and other potentially dangerous situations. Equipped with a sliding device with wheels for optimal sliding on the rail.

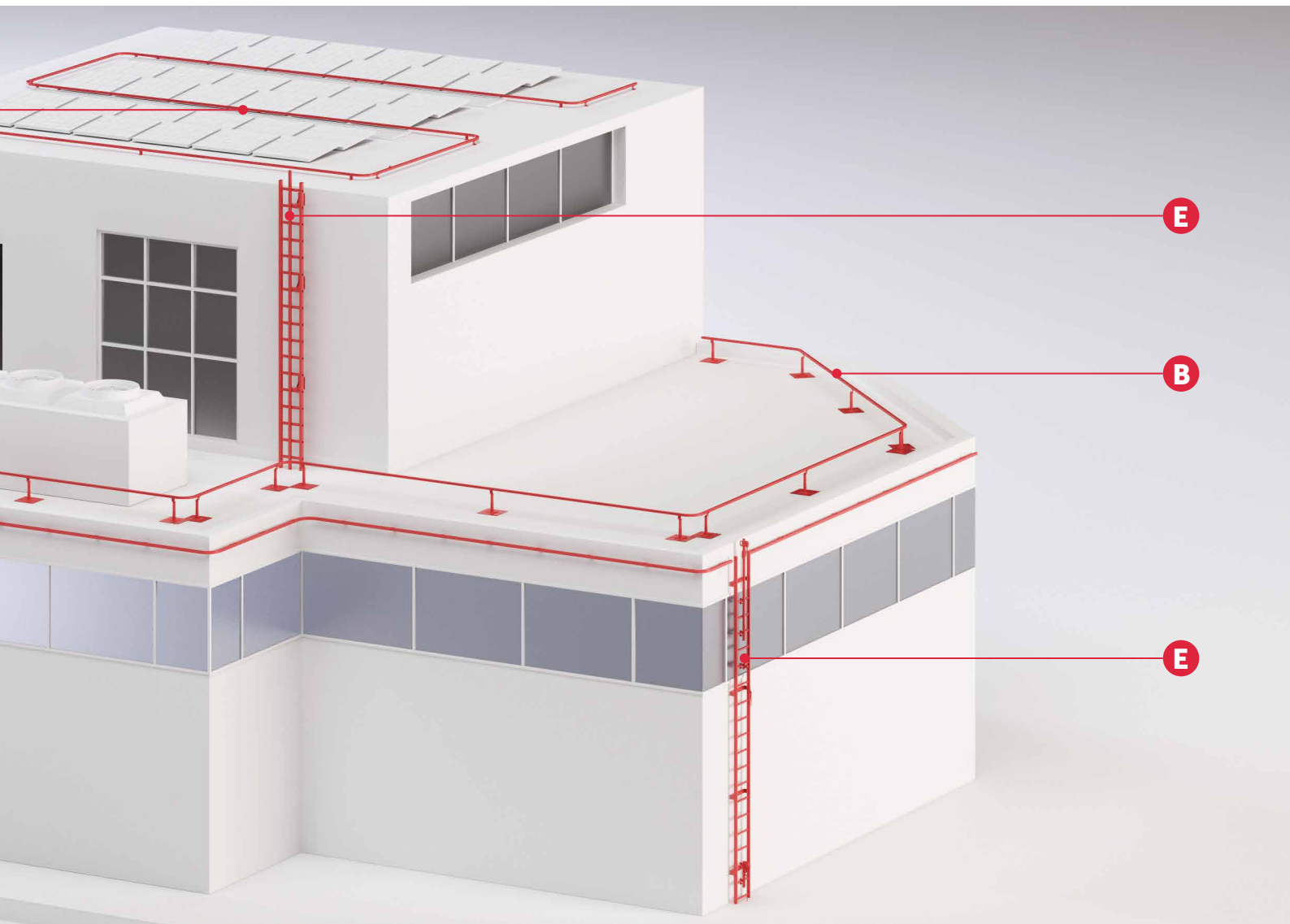

**D** H-RAIL ON WALL

Rigid pass-through life line for horizontal use for direct application with or without metal brackets on different types of structure. Sliding device suitable for assembled rail with both vertical and horizontal fastening.

**E** V-RAIL

Rigid pass-through life line for vertical use for direct application on different types of substructure or for application with metal brackets on the rungs of fixed ladders. Equipped with a sliding device to lock immediately if the operator falls.

**F** S-RAIL

Rigid pass-through life line for use in suspension for direct application with metal brackets on different types of substructure. The sliding device is designed to facilitate the movement of the operator during suspended work, ensuring comfort of use.

# H-RAIL

## HORIZONTAL RAIL SYSTEM

### TO ALWAYS WORK ON THE RIGHT RAIL.

The H-RAIL rail LIFELINE system is safe and versatile. It is possible to create horizontal rigid LIFELINES, using only a few fasteners, and thanks to the modularity of the system it is possible to create curved or straight rigid LIFELINES. H-RAIL is also suitable for suspended work on building façades. The three sliding devices available meet different needs: choose the one that suits you and operate safely with H-RAIL!

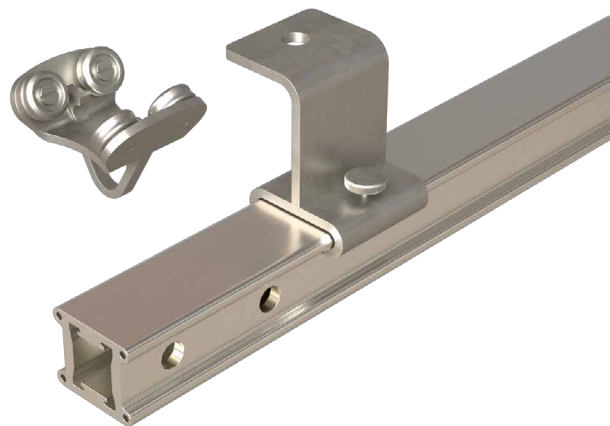

# H-RAIL | overview

## H-RAIL ON FLOOR

HORIZONTAL RAIL SYSTEM

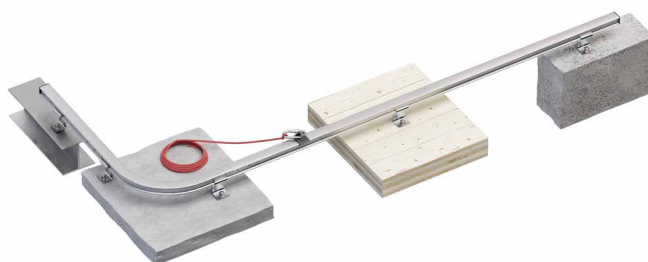

➤ PAGE 72

## H-RAIL + TOWER

HORIZONTAL RAIL SYSTEM ON SUPPORTS

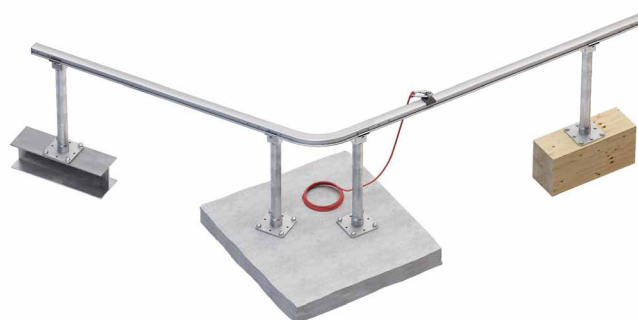

➤ PAGE 74

## H-RAIL OVERHEAD

HORIZONTAL OVERHEAD RAIL SYSTEM



➤ PAGE 76

## H-RAIL ON WALL

HORIZONTAL WALL-MOUNTED RAIL SYSTEM



➤ PAGE 78

# H-RAIL ON FLOOR

## HORIZONTAL RAIL SYSTEM



### UNOBTRUSIVE

The rail ensures a small footprint on the cover and thus a minimal visual impact.

### COMPLETE

The system can be used for different applications (horizontal, vertical and overhead) by using the specific sliding devices.

### FAST INSTALLATION

Thanks to the large centre distance between the rail fasteners (6 m), assembly requires a limited number of fastening points.



LOAD DIRECTION



TYPES OF APPLICATION



VIDEO



MANUALS



▼ Installation of H-RAIL rail on flat roof for use as a walkway for the maintenance of a photo-voltaic system.





## H-RAIL COMPONENTS

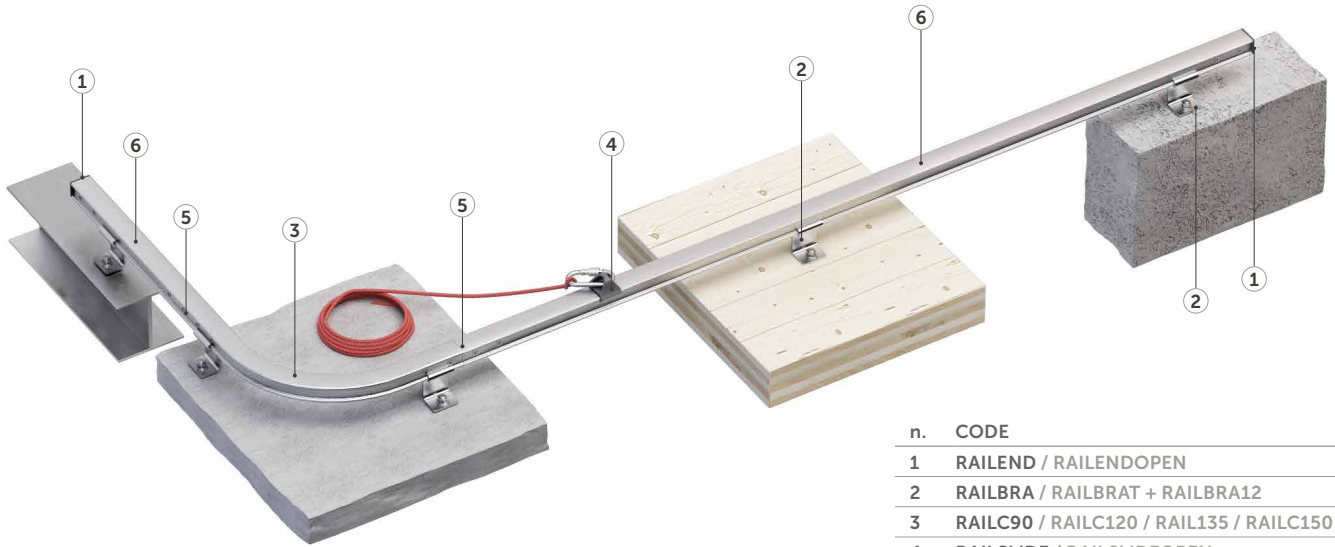

n.	CODE
1	RAILEND / RAILENDOPEN
2	RAILBRA / RAILBRAT + RAILBRA12
3	RAILC90 / RAILC120 / RAIL135 / RAILC150
4	RAILSLIDE / RAILSLIDEOPEN
5	RAILJUN
6	RAIL3000

## TECHNICAL DATA\*

substructure	minimum thickness	fastening		work method	max supports pacing [m]	max. no. of system operators	no. of users per span
		direct	with RAILBRA				
GL24h	100 mm	VGS Ø11	HBS12	 fall protection/ restraint	6	4	4
CLT	100 mm	VGS Ø11	HBS12				
C20/25	140 mm	AB1	SKS10	 suspension	1,5	4	1
S235JR	6 mm	EKS10	EKS10				

\* The values indicated are the result of experimental tests carried out under the supervision of third parties in accordance with the standard referred to. For a calculation report with minimum distances according to the relevant standard requirements, the substructure must be checked by a qualified engineer before installation.

### RAILSLIDE

Universal sliding device for rail. Its shape ensures excellent sliding. With locking screw included. Anchorage point also suitable for large connectors.



### RAILBRA

Universal support for maximum versatility and convenience in mounting on different substrates.



### RAILENDOPEN

Openable end stop, allowing entry and exit from the system.



### RAIL3000

Available in various RAL colours on request.

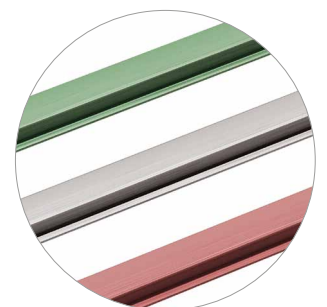

# H-RAIL + TOWER

## HORIZONTAL RAIL SYSTEM ON SUPPORTS



### COMBINABLE

It can be assembled in combination with all TOWER brackets.



### FUNCTIONAL

The combination with TOWER supports gives the possibility to raise the rail to overcome obstacles in the roof.

### EASY

The rail is simply mounted on the TOWER brackets using the dedicated plate.



LOAD DIRECTION



TYPES OF APPLICATION



▼ *Installation of H-RAIL rail with TOWER supports on a flat, insulated concrete roof.*



## H-RAIL COMPONENTS

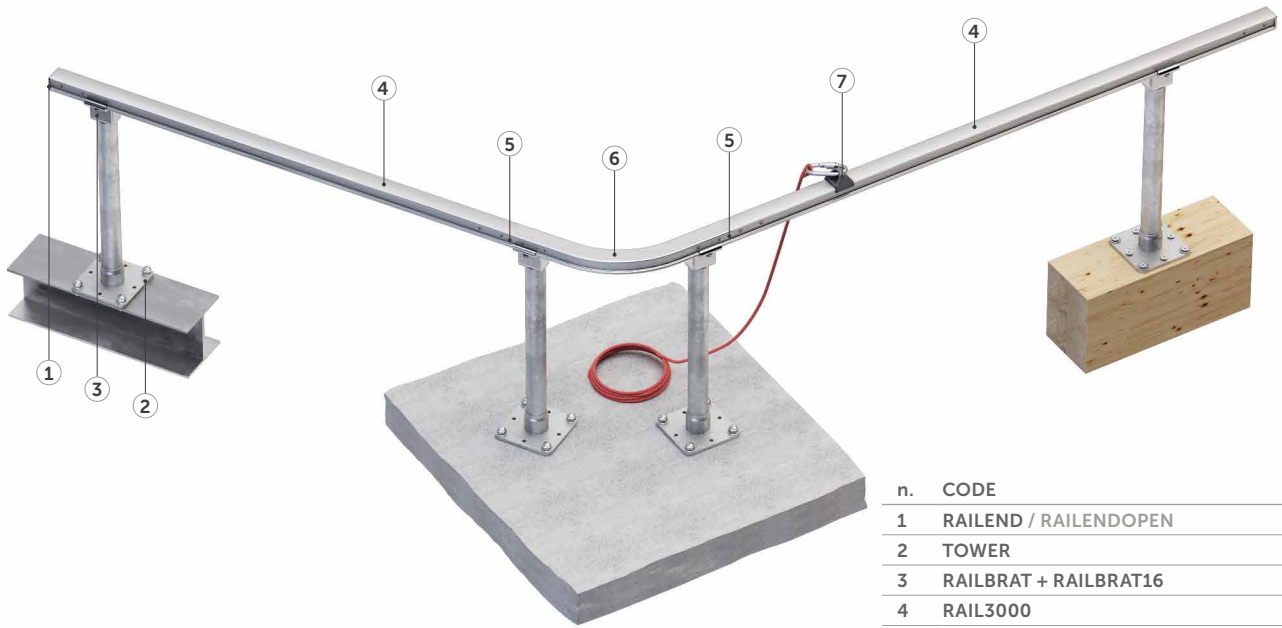

n.	CODE
1	RAILEND / RAILENDOPEN
2	TOWER
3	RAILBRAT + RAILBRAT16
4	RAIL3000
5	RAILJUN
6	RAILC120 / RAILC90 / RAILC135 / RAILC150
7	RAILSLIDE / RAILSLIDEOPEN

## TECHNICAL DATA\*

substructure	minimum thickness	TOWER fastening	rail supports	work method	max supports pacing [m]	max. no. of system operators	no. of users per span
GL24h	160 x 160 mm	VGS Ø9	RAILBRAT + RAILBRA16	fall protection/ restraint	6	4	4
CLT	200 mm	VGS Ø9					
C20/25	140 mm	AB1 Ø12					
		rod Ø12 VIN-FIX HYB-FIX					
S235JR	6 mm	EKS + ULS + MUT					

\* The values indicated are the result of experimental tests carried out under the supervision of third parties in accordance with the standard referred to. For a calculation report with minimum distances according to the relevant standard requirements, the substructure must be checked by a qualified engineer before installation.

### RAILSLIDEOPEN

Openable sliding device. It can be installed and removed in any position on the rail.



### RAILC120, RAILC135, RAILC150

H-RAIL includes bends with different angles to meet specific site requirements.



### RAILJUN

Universal rail joint. Simple to install. Complete with fastening screws.



### RAILJUNTOOL

Jig for drilling joint holes for rails cut to size on site.



# H-RAIL OVERHEAD

## HORIZONTAL OVERHEAD RAIL SYSTEM



### ADJUSTABLE

Possibility of assembling the rail directly on various substructures with the appropriate plates.



### FUNCTIONAL

Rail that allows operators to work with their hands free and in safety by using sliding and retractable devices.

### SAFE

The system is also suitable and tested for multi-operator suspension use.



LOAD DIRECTION



TYPES OF APPLICATION

▼ *Installation of H-RAIL ceiling rail for suspended work for façade cleaning.*



## H-RAIL COMPONENTS

n.	CODE
1	RAILEND / RAILENDOPEN
2	RAILBRAOH
3	TOWER
4	RAILBRAT + RAILBRAT16
5	RAILC150 / RAILC90 / RAILC120 / RAILC135
6	RAILJUN
7	RAIL3000
8	RAILSLIDEOH

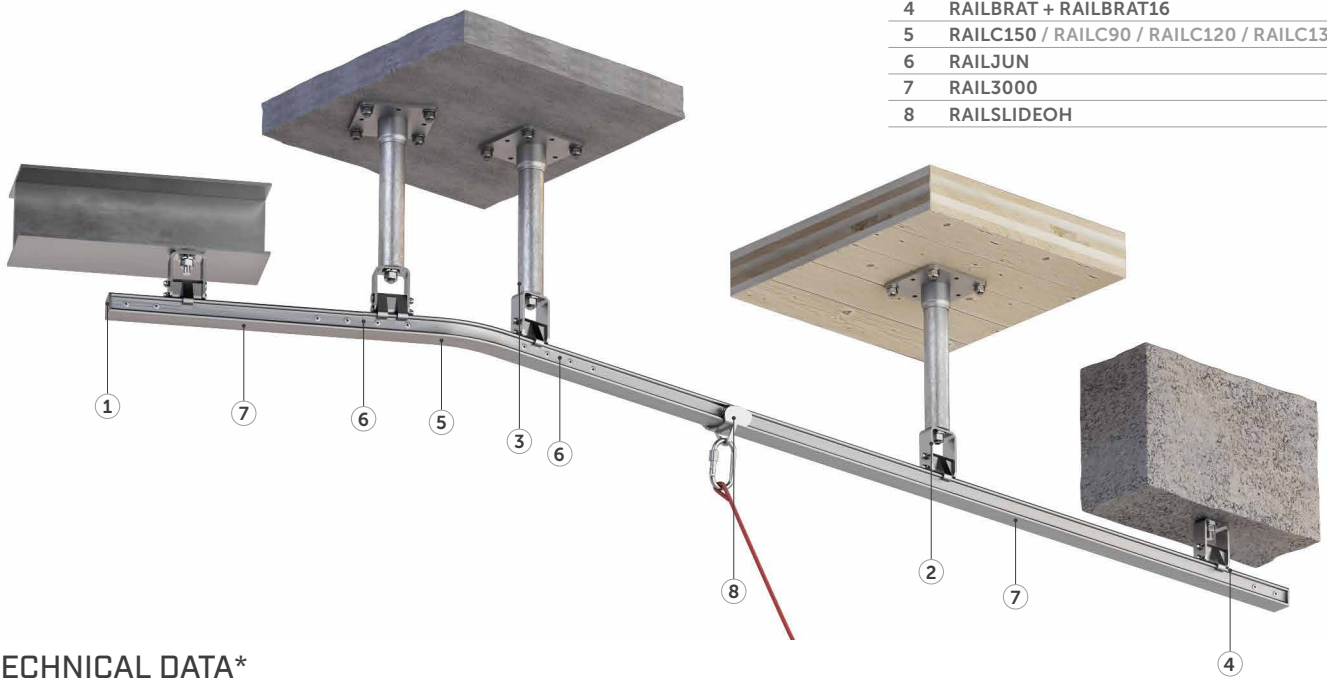

## TECHNICAL DATA\*

substructure	minimum thickness	fastening	
		direct	with RAILBRA
GL24h	100 mm	VGS Ø11	HBS12
CLT	200 mm	VGS Ø11	HBS12
C20/25	150 mm	AB1	SKS10
S235JR	6 mm	EKS10	EKS10
TOWER	-	-	-

work method	max supports spacing [m]	max. no. of system operators	no. of users per span
fall protection/restraint	6	4	4
suspension	1,5	4	1

\* The values indicated are the result of experimental tests carried out under the supervision of third parties in accordance with the standard referred to. For a calculation report with minimum distances according to the relevant standard requirements, the substructure must be checked by a qualified engineer before installation.

### RAILSLIDEOH

Sliding device for overhead application for fall protection and suspension work. Equipped with four wheels that guarantee excellent sliding even under vertical load.



### RAILBRAOH

Support for overhead application. It allows a two-step installation by first installing the bracket on the substructure and then the rail.

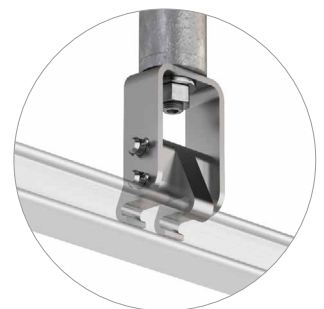

### H-RAIL

H-RAIL can also be installed without support directly on various substructures. Use the RAILFIXTOOL template to drill the holes.



### RAILFIXTOOL

Positioning jig and drilling guide for direct installation on various substructures.



# H-RAIL ON WALL

## HORIZONTAL WALL-MOUNTED RAIL SYSTEM



### AESTHETICS

It can be fixed directly to the structure without the use of special plates.

### COMFORT

Operation by means of a sliding device that can be opened at any point of the system.

### ASSEMBLY

It can be assembled on different substructures (timber, concrete and steel) to suit all construction site requirements.



LOAD DIRECTION



TYPES OF APPLICATION

▼ *Installation of H-RAILON WALL rail for façade maintenance.*



## H-RAIL COMPONENTS

n.	CODE
1	RAILEND / RAILENDOPEN
2	RAIL3000
3	RAILBRA / RAILBRAT + RAILBRAT12
4	RAILVC90
5	RAILVC135
6	RAILJUN
7	RAILSLIDE / RAILSLIDEOPEN

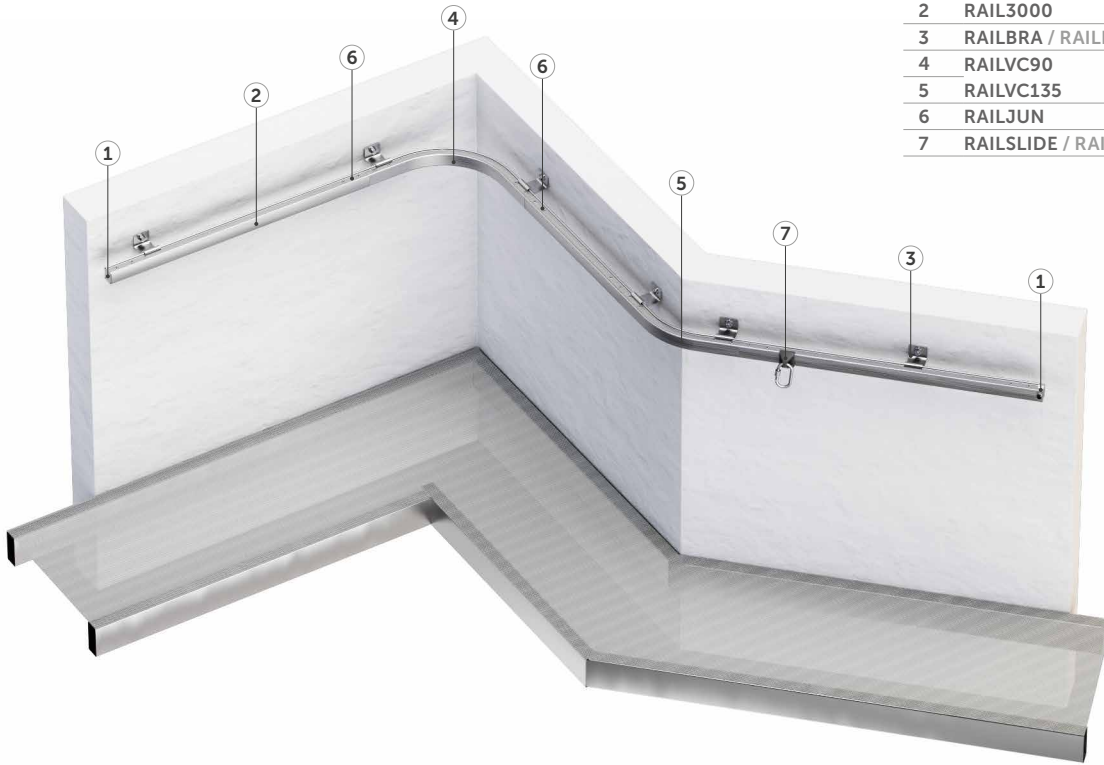

## TECHNICAL DATA\*

substructure	minimum thickness	fastening		work method	max supports pacing [m]	max. no. of system operators	no. of users per span
		direct	with RAILBRA				
GL24h	100 mm	VGS Ø11	HBS12	fall protection/ restraint	6	4	4
CLT	200 mm	VGS Ø11	HBS12				
C20/25	150 mm	AB1	SKS10	suspension	1,5	4	1
S235JR	6 mm	EKS10	EKS10				

\* The values indicated are the result of experimental tests carried out under the supervision of third parties in accordance with the standard referred to. For a calculation report with minimum distances according to the relevant standard requirements, the substructure must be checked by a qualified engineer before installation.

### RAILSLIDE

Universal sliding device for rail. Its shape ensures excellent sliding. With locking screw. Anchorage point also suitable for large connectors.



### RAILFIXTOOL

Positioning jig and drilling guide for direct installation on various substructures.



### RAILBRAT, RAILBRA12

Universal support for maximum versatility and convenience in mounting on different substrates.



# H-RAIL | components

## MAIN COMPONENTS FOR HORIZONTAL RAIL

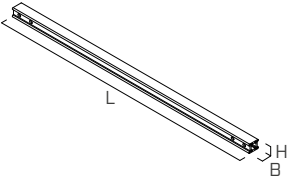
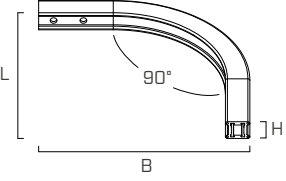
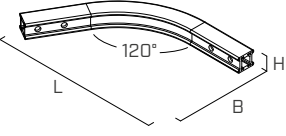
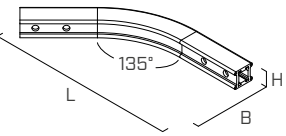
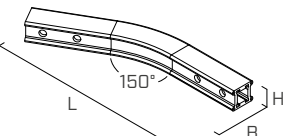
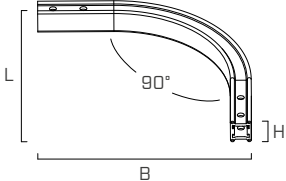
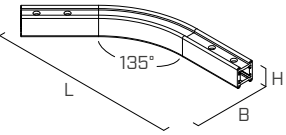
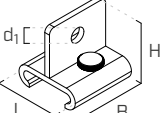
GROUP	CODE	description	material	B	H	L	pcs	
				[mm]	[mm]	[mm]		
RAIL	RAIL3000	3 m aluminium rail	EN AW 6063 (T6)	49	41	3000	1	
	RAILC90	aluminium 90° bend for rail	EN AW 6063 (T6)	424	41	424	1	
	RAILC120	aluminium 120° bend for rail	EN AW 6063 (T6)	292	41	463	1	
	RAILC135	aluminium 135° bend for rail	EN AW 6063 (T6)	221	41	450	1	
	RAILC150	aluminium 150° bend for rail	EN AW 6063 (T6)	154	41	418	1	
	RAILVC90	aluminium vertical 90° bend for rail	EN AW 6063 (T6)	400	49	400	1	
	RAILVC135	aluminium vertical 135° bend for rail	EN AW 6063 (T6)	214	49	447	1	
	SUPPORT	RAILBRA	single element support with hole $d_1 = 12$ mm	AISI 304 stainless steel grade 1.4301	60	84	78	1
RAILBRAT		coupled support upper element with hole $d_1 = 12$ mm to combine with RAILBRA12 or RAILBRA16	AISI 304 stainless steel grade 1.4301	60	64	60	1	

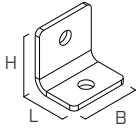
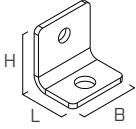
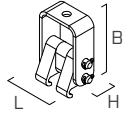
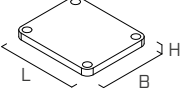
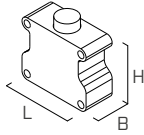
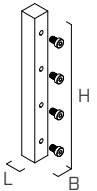
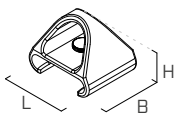
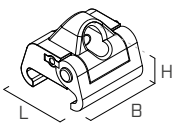
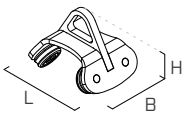
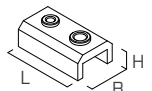
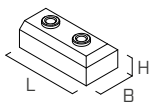

GROUP	CODE	description	material	B	H	L	pcs	
				[mm]	[mm]	[mm]		
SUPPORT	RAILBRA12	coupled support bottom element M12 fastener for RAILBRAT included	AISI 304 stainless steel grade 1.4301	60	60	45	1	
	RAILBRA16	coupled support bottom element M16 fastener for RAILBRAT included	AISI 304 stainless steel grade 1.4301	60	60	45	1	
	RAILBRAOH	support for overhead application	AISI 304 stainless steel grade 1.4301	114	60	84	1	
TERMINAL ELEMENT	RAILEND	fixed end element fastening screws included	AISI 304 stainless steel grade 1.4301	41	4	49	1	
	RAILENDOPEN	openable end element fastening screws included	AISI 304 stainless steel grade 1.4301	20	47	49	1	
JOINT	RAILJUN	junction element for rail fastening screws included	AISI 304 stainless steel grade 1.4301	25	240	25	1	
SLIDING DEVICE	RAILSLIDE	sliding device	AISI 304 stainless steel grade 1.4301	50	49	60	1	
	RAILSLIDEOPEN	removable sliding device	AISI 304 stainless steel grade 1.4301	50	42	60	1	
	RAILSLIDEOH	sliding device for overhead applications and suspended work	AISI 304 stainless steel grade 1.4301	70	72	95	1	
TOOL	RAILFIXTOOL	template for holes for direct fastening on the rail	EN AW 6082 - 1.1191 (C45E) aluminium	70	45	120	1	
	RAILJUNTOOL	template for rail junction holes	EN AW 6082 - 1.1191 (C45E) aluminium	62	45	130	1	

# V-RAIL

## VERTICAL RAIL SYSTEM



### TOTAL CONTROL

Guided type fall arrester with integrated energy absorber, which allows a controlled ascent and descent in safe conditions.

### FUNCTIONAL

It can be installed on walls inclined at an angle of up to 15° from the vertical.

### PRACTICAL

Possibility of off-centre assembly of the system on a ladder.



TYPES OF APPLICATION

▼ Installation of V-RAIL rail on existing ladder for roof maintenance.



## V-RAIL COMPONENTS

n. CODE

1	RAILENDOPEN
2	VRAILBRAL
3	RAIL3000
4	VRAILJUN
5	VRAILSLIDE
6	VRAILSUPTOP
7	RAILVC90 / RAILVC135
8	VRAILSUPD

n. CODE

1a	RAILENDOPEN
2a	VRAILBRAW
3a	RAIL3000
4a	VRAILJUN
5a	VRAILSLIDE
6a	VRAILSUPTOP
7a	RAILVC90 / RAILVC135
8a	VRAILSUPD

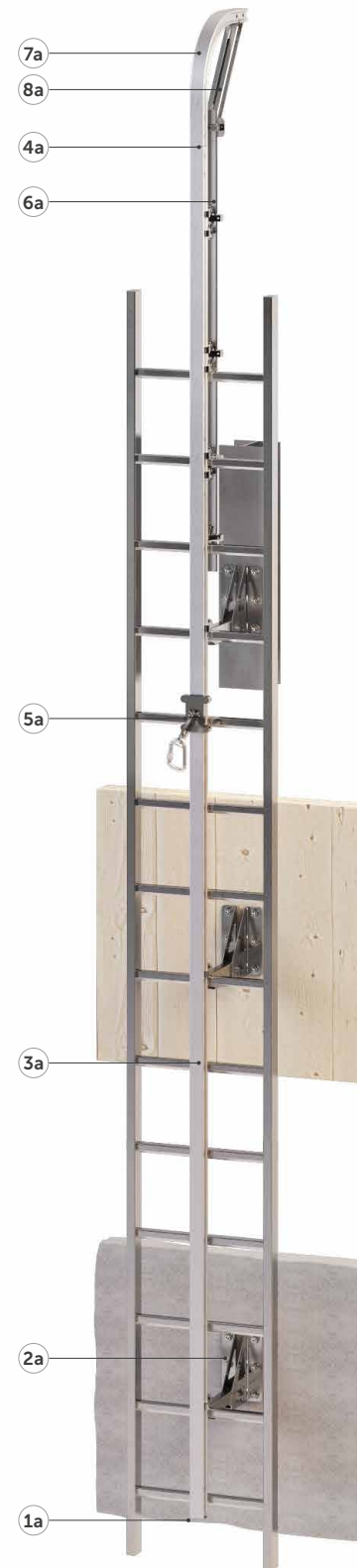

## CODES AND DIMENSIONS

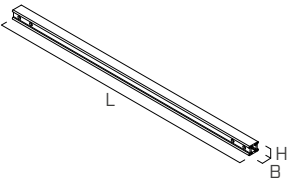
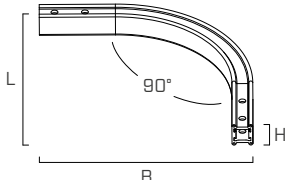
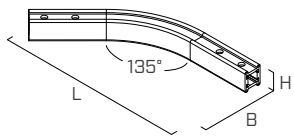
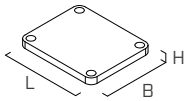
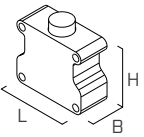
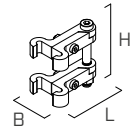
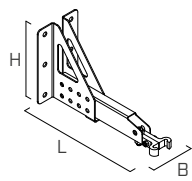
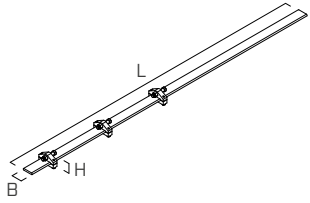
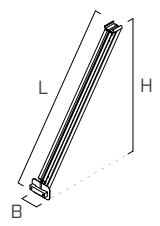
GROUP	CODE	description	material	B	H	L	pcs	
				[mm]	[mm]	[mm]		
RAIL	RAIL3000	3 m aluminium rail	EN AW 6063 (T6)	49	41	3000	1	
	RAILVC90	aluminium vertical 90° bend for rail	EN AW 6063 (T6)	400	49	400	1	
	RAILVC135	aluminium vertical 135° bend for rail	EN AW 6063 (T6)	214	49	447	1	
TERMINAL ELEMENT	RAILEND	fixed end element	AISI 304 stainless steel grade 1.4301	41	4	49	1	
	RAILENDOPEN	openable end element	AISI 304 stainless steel grade 1.4301	20	47	49	1	
SUPPORT	VRAILBRAL	support for fastening on ladder	AISI 304 stainless steel grade 1.4301	66	107	100	1	
	VRAILBRAW	support for wall mounting	AISI 304 stainless steel grade 1.4301	140	275	354	1	
	VRAILSUPTOP	rail extension support	AISI 304 stainless steel grade 1.4301	79	52	1500	1	
	VRAILSUPD	diagonal support for horizontal exit rail	AISI 304 stainless steel grade 1.4301	95	608	735	1	

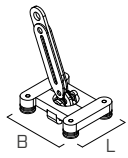
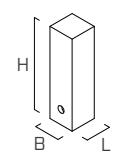
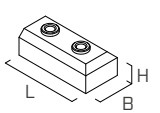
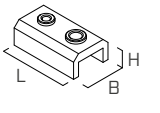
GROUP	CODE	description	material	B	H	L	pcs	
				[mm]	[mm]	[mm]		
SLIDING DEVICE	VRAILSLIDE	sliding device with energy absorber for vertical rigid lifeline	AISI 304 stainless steel grade 1.4301	118	-	97	1	
JOINT	VRAILJUN	joint element for vertical rail	AISI 304 stainless steel grade 1.4301	25	90	25	1	
TOOL	RAILJUNTOOL	template for rail junction holes	EN AW 6082 - 1.1191 (C45E) aluminium	-	-	-	1	
	RAILFIXTOOL	template for holes for direct fastening on the rail	EN AW 6082 - 1.1191 (C45E) aluminium	-	-	-	1	

### VRAILSLIDE

Sliding device with integrated energy absorber allowing vertical movements in comfort and safety.



### RAILENDOPEN

Openable end element allowing fast and safe entry into the system using the standard sliding device.



### VRAILBRAL

Support for vertical rail adaptable to any standard ladder. Simple to install.



### RAIL3000

Available in various RAL colours on request.

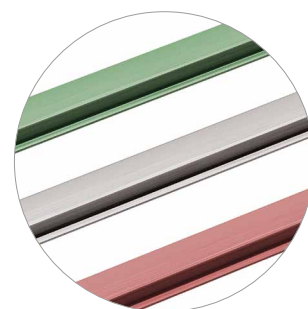

# GREEN LINE

## LIFE LINE ON SUPPORTS WITH BALLAST

EN  
795:2012 C

CEN/TS  
16415:2013

### FUNCTIONAL

Supporting system that does not require roof perforation. It avoids thermal bridges and respects the waterproofing of the structure.

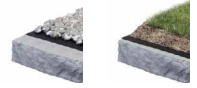

### FAST INSTALLATION

The system consists of few components which facilitate and speed up mounting.

### UNOBTRUSIVE

System with reduced visual impact, almost invisible once installed.



LOAD DIRECTION



TYPES OF APPLICATION

▼ *Life line on supports installed at "dead weight" on a flat roof.*



MANUALS



## PATROL LIFELINE COMPONENTS

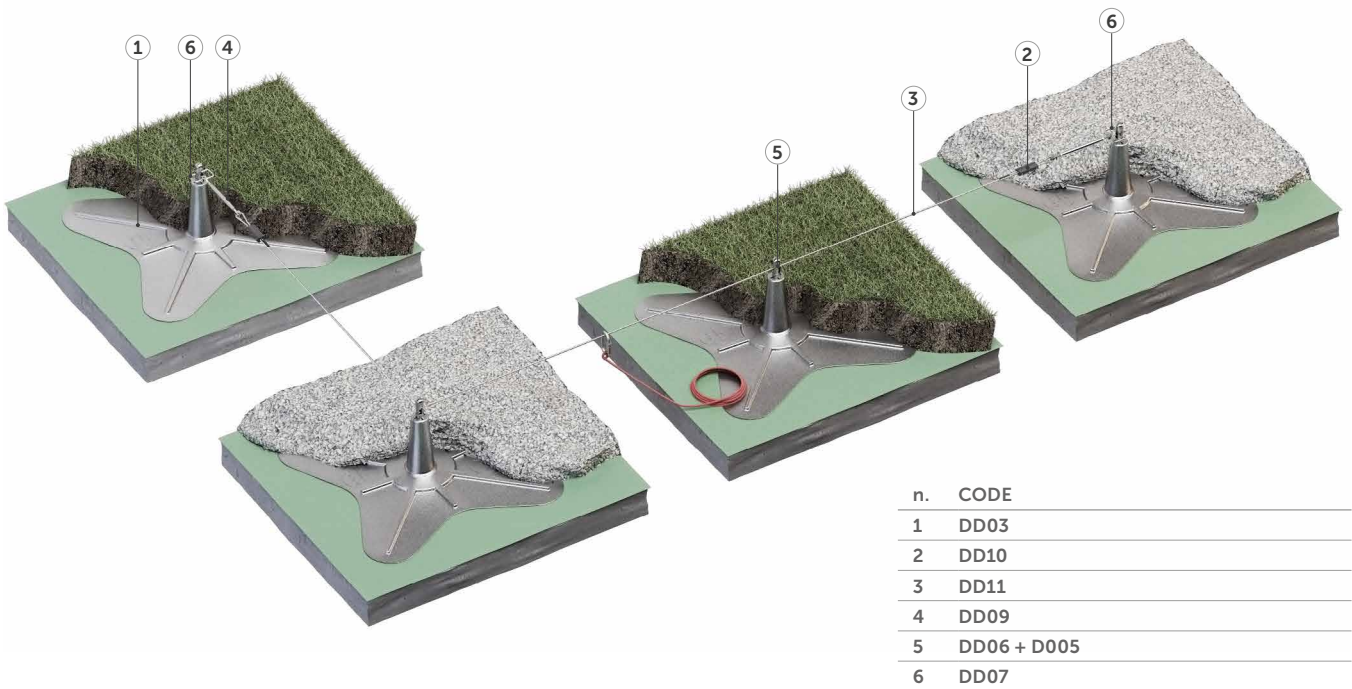

## TECHNICAL DATA

		GREEN LINE tensioner
minimum spacing	$X_{min}$ [m]	1,5
maximum spacing	$X_{max}$ [m]	8
maximum deflection	$Y_{max}$ [m]	2,38

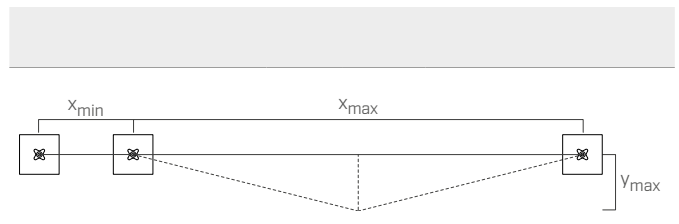

		system characteristics
ballast support dimensions	[cm]	300 x 300 ( $\pm 5\%$ ) x 30 ( $\pm 1\%$ )
support for ballast		glass-fibre reinforced plastic cone with laminated ballast mat (frost-resistant)
distance between supports	[m]	1,5 - 8
minimum weight of material for ballast*	[kg/m <sup>2</sup> ]	80
steel rope type	[mm]	$\varnothing 8$ (7 x 19)
durability		weatherproof (UV-resistant, it can be used in frost and heat)





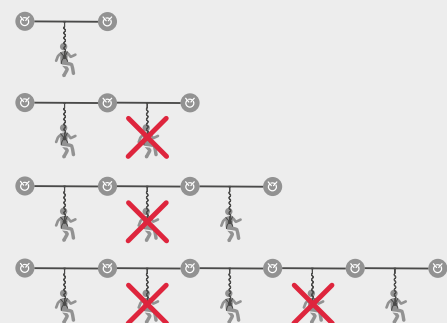

\* If an additional mat is used: 30 kg/m<sup>2</sup>. All technical data are average values. They are based on measurements from various test institutes and measurement laboratories. We reserve the right to make technical changes

### NUMBER OF USERS

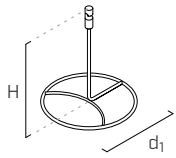
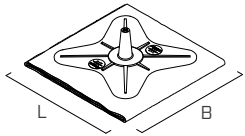
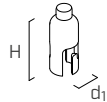
Unlimited. Each operator working on one span must have at least both spans beside it free of operators. See diagram aside.

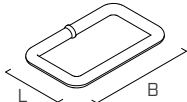

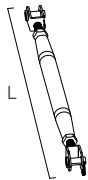
## CODES AND DIMENSIONS

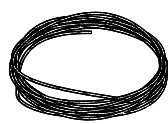
CODE	description	material	d <sub>1</sub> [mm]	B [mm]	H [mm]	L [mm]	s [mm]	pcs	
DD02	internal side anchor point	AISI 316L stainless steel grade 1.4404	250	-	300	-	-	1	
DD03	tarpaulin with possibility of installing ballasts 3 x 3 m with external cone	glass fibre reinforced plastic (GFRP)	-	3000	-	3000	-	1	
DD05	fastening head	AISI 316L stainless steel grade 1.4404	28	-	60	-	-	1	
DD06	fastening ring	AISI 316L stainless steel grade 1.4404	31,5	-	23	-	-	1	
DD07	square ring	AISI 316L stainless steel grade 1.4404	-	57,5	-	87,5	-	1	
DD08	eyelet to form rope loop	AISI 316L stainless steel grade 1.4404	-	38	-	58	-	1	
DD09	cable tensioner	AISI 316L stainless steel grade 1.4404	-	-	-	290-415	-	1	
DD12	pair of clamps and plate set	aluminium	-	-	-	-	-	1	
CABLE	Ø8 x 19 steel rope	AISI 316L stainless steel grade 1.4404	Ø8	-	-	-	-	1	



# NOISE PROTECTION FOR METAL SHEET ROOFS

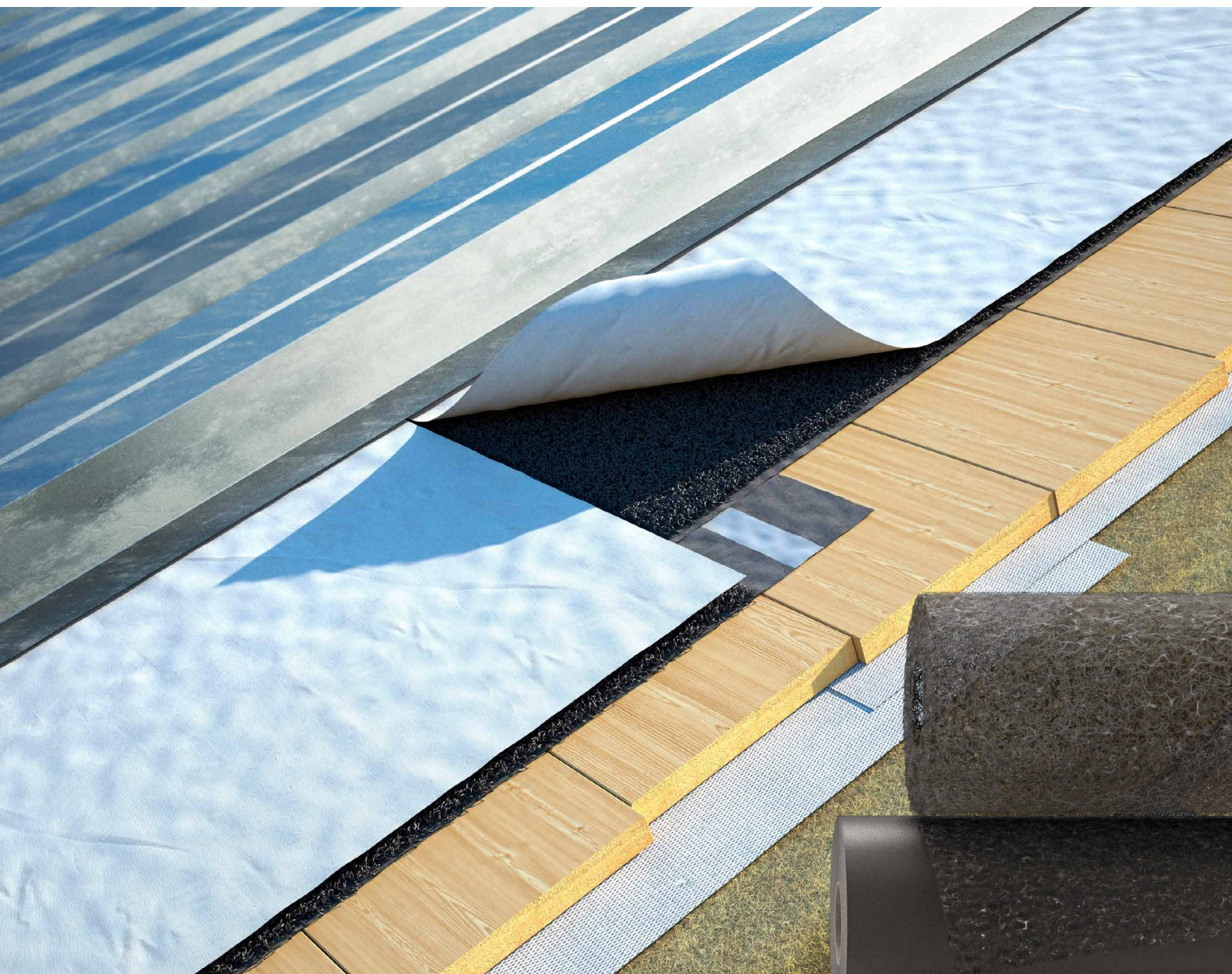

TRASPIR METAL is a highly breathable membrane paired with a 3D mat and a protective felt. The top felt prevents impurities from getting into the mat and improves resistance to treading, preventing water stagnation. It is a soundproofing solution, the only one of its kind to have been tested on site for acoustic insulation against the sound of driving rain on the roof.

**SO THE NOISE STAYS OUT, AND YOU CAN SLEEP SOUNDLY.**

Find out how TRASPIR METAL protects you from noise



[www.rothoblaas.com](http://www.rothoblaas.com)



**rothoblaas**

Solutions for Building Technology

# TEMPORARY DEVICES

## TEMPORARY



### TEMPORARY LIFE LINE

- Horizontal temporary life line that is easy to install, with 30 mm polyester band with high load bearing capacity and excellent visibility.
- Number of users: 2 (**1 each span**)



CODE	description	standard	pcs
TEMP20	temporary life line L = 20 m	EN 795:2012 B+C, CEN/TS 16415:2013	1

### COMPLEMENTARY PRODUCTS

CODE	description	standard	pcs
OVALSTE	large carabiner	CE - EN 362/M	2

▼ Temporary lifeline installed on fixed and temporary anchor points.

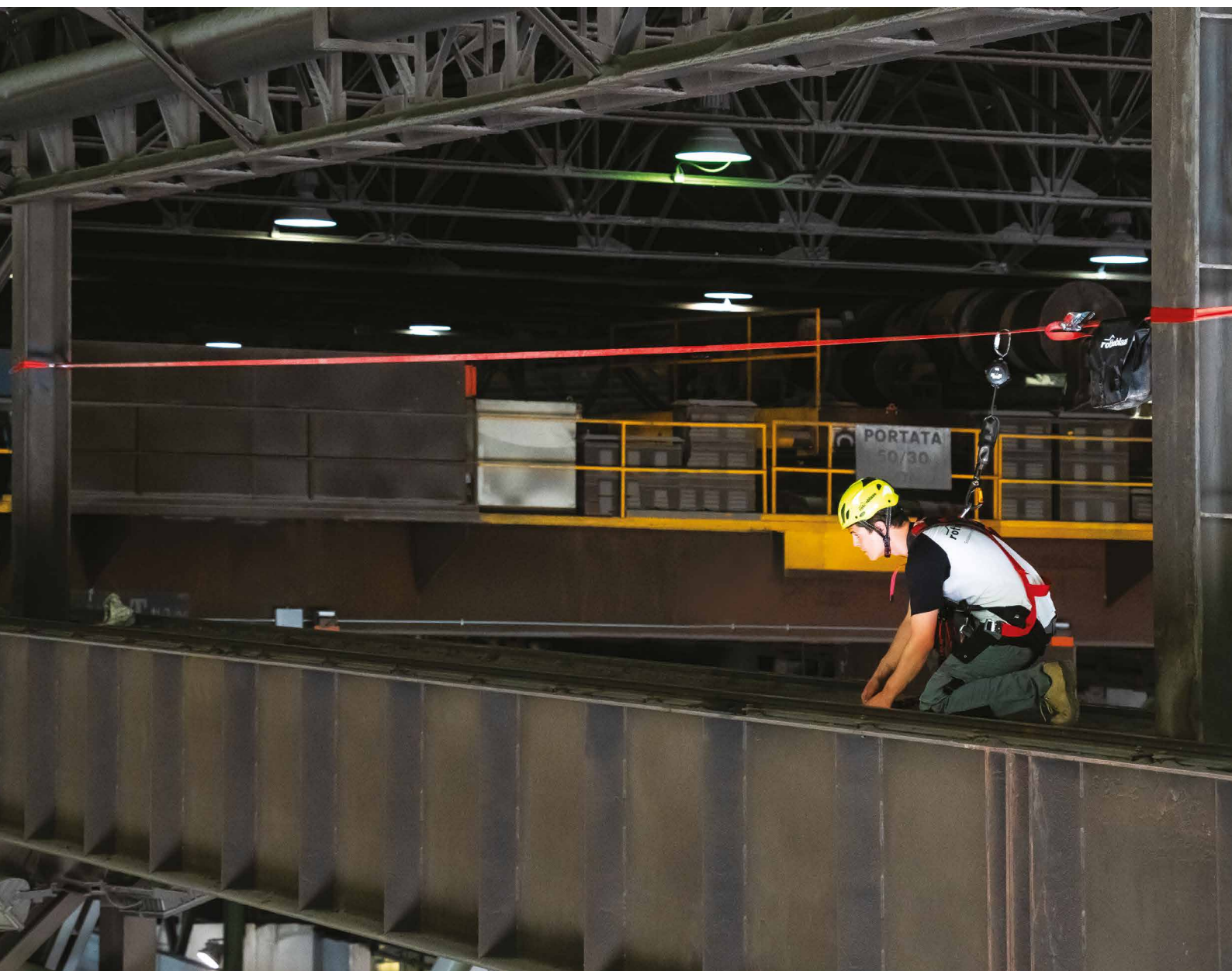

# HOLD-SYSTEM®



## TEMPORARY HORIZONTAL ANCHORING DEVICE



- Complete system of carabiners and webbing for fastening
- Quick and easy tensioning of the system by one operator using Prusik knot system and self-locking device
- The structure or anchorage points to which the system will be installed must withstand a recommended stress of 9 kN
- Number of users: **2**
- Maximum span: **12 m**
- $R_{min}$  (anchor points)  $\leq$  **6 - 9 kN**

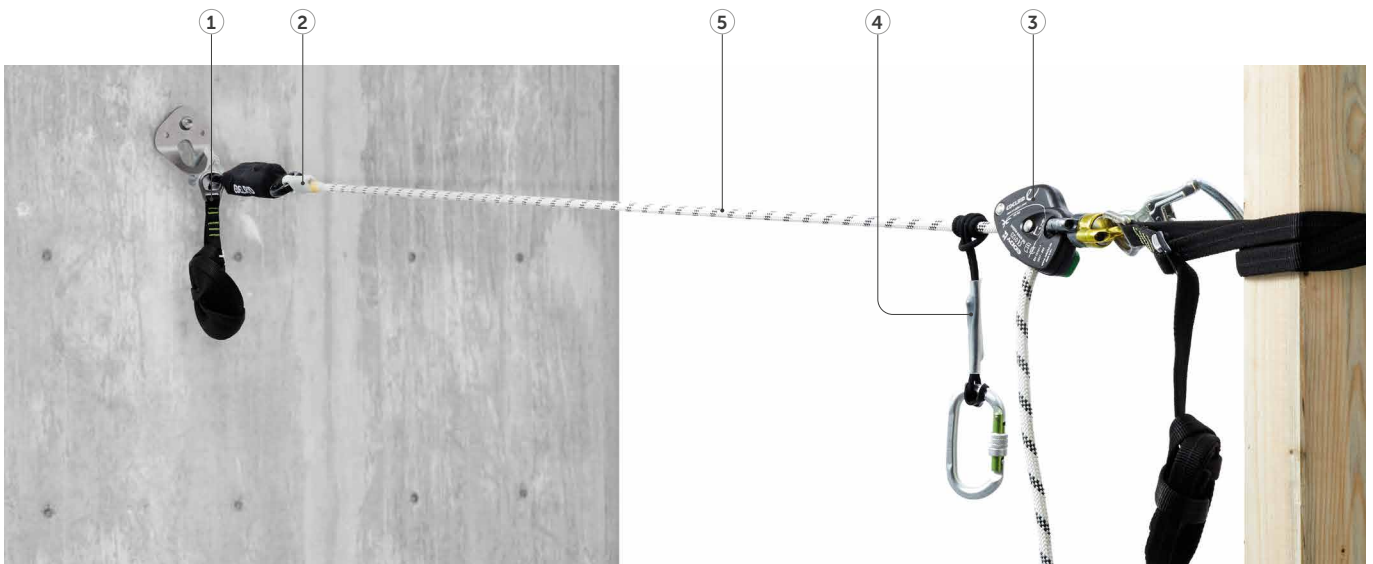

### n. description

1	assembly with carabiner or webbing
2	product label
3	self-locking device with emergency release
4	Prusik locking knot for tensioning
5	lifeline for connection with retractable fall arrest device or lanyards with energy absorber

## CODES AND DIMENSIONS

CODE	standard	L [m]	pcs
TEMPLUS20	EN 795:2012 B+C, CEN/TS 16415:2013	20	1
TEMPLUS30	EN 795:2012 B+C, CEN/TS 16415:2013	30	1
TEMPLUS40	EN 795:2012 B+C, CEN/TS 16415:2013	40	1
TEMPLUS60	EN 795:2012 B+C, CEN/TS 16415:2013	60	1

### COMPLEMENTARY PRODUCTS

CODE	description	L [m]	pcs
HSG2RB	retractable webbing device EN 360	2	1



HSG2RB



# ANCHOR POINTS

# ANCHOR POINTS

# ANCHOR POINTS

<b>WING</b> ANCHOR POINT FOR WORK AT HEIGHT AND IN SUSPENSION .....	98
<b>HOOK EVO</b> ANCHOR POINT.....	100
<b>HOOK EVO 2.0</b> ANCHOR POINT.....	101
<b>HOOK SPIKE</b> ANCHOR POINT WITH LADDER HOOK.....	102
<b>LOOP</b> ANCHOR POINT.....	104
<b>SLIM</b> ANCHOR POINT FOR SMALL STRUCTURES.....	105
<b>KITE</b> ANCHOR POINT.....	106
<b>AOS</b> ANCHOR POINT.....	108
<b>SIANK</b> ANCHOR POINT FOR STANDING SEAM METAL ROOFS .....	110
<b>GREEN POINT</b> ANCHOR POINT WITH BALLASTS .....	111
<b>GLUE ANCHOR</b> GLUED ANCHOR POINT FOR BITUMEN AND PVC ROOFS .....	112
<b>WING 2</b> ANCHOR POINT FOR SUSPENDED WORK.....	114
<b>MOBILE</b> MOBILE ANCHOR POINT.....	114
<b>ROD</b> ANCHOR POINT FOR STEEL STRUCTURES .....	115
<b>CARRIER</b> SLIDING ANCHOR FOR STEEL STRUCTURES.....	115
<b>AOS01 + TOWER/TOWER A2</b> ANCHOR POINT FOR TIMBER, CONCRETE AND STEEL ROOFS .....	118
<b>AOS01 + TOWER XL</b> ANCHOR POINT WITH INCREASED BOTTOM PLATE FOR TIMBER, STEEL AND CONCRETE ROOFS.....	120
<b>AOS01 + SHIELD</b> ANCHOR POINT FOR TRAPEZOIDAL METAL ROOFS.....	122
<b>AOS01 + SHIELD 2</b> ANCHOR POINT FOR TRAPEZOIDAL METAL ROOFS.....	123
<b>AOS01 + SIANK 4</b> ANCHOR POINT FOR STANDING SEAM METAL ROOFS .....	124
<b>AOS01 + SEAMO</b> ANCHOR POINT FOR ROUND SEAM METAL ROOFS.....	125
<b>AOS01 + COPPO</b> ANCHOR POINT FOR ROOFS WITH FAUX TILES .....	126
<b>AOS01 + BLOCK</b> ANCHOR POINT WITH BALLAST FOR FLAT ROOFS.....	127

# THE RIGHT ANCHOR POINT FOR EACH STRUCTURE

## TIMBER



WING

page 99 <



WING

page 99 <



LOOP

page 104 <



SLIM

page 105 <



HOOK EVO

page 100 <

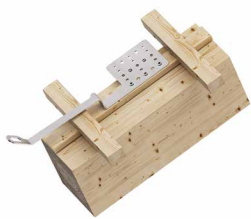

HOOK EVO 2.0

page 101 <



HOOK SPIKE

page 103 <



AOS

page 109 <



KITE

page 107 <



AOS01 + TOWER/A2

page 119 <



AOS01 + TOWER XL

page 121 <

## STEEL



WING

page 99 <



AOS

page 109 <



KITE

page 107 <



WING 2

page 114 <



AOS01 + TOWER/A2

page 119 <



MOBILE

page 114 <



ROD

page 115 <



CARRIER

page 115 <





WING 2

page 114 <



KITE

page 107 <



LOOP

page 104 <



HOOK EVO 2.0

page 101 <



WING

page 99 <



AOS01 + TOWER XL

page 121 <



AOS01 + TOWER XL

page 121 <



AOS01 + TOWER/A2

page 119 <



AOS

page 109 <



AOS01 + SEAM0

page 125 <

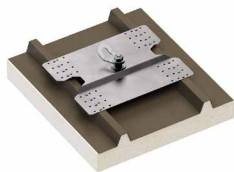

AOS01 + SHIELD 2

page 123 <



AOS01 + SHIELD

page 122 <



AOS01 + TOWER XL

page 121 <



SIANK

page 110 <

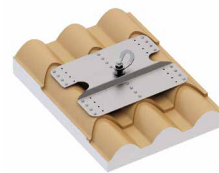

AOS01 + COPPO

page 126 <



AOS01 + SIANK 4

page 124 <



GLUE ANCHOR

page 113 <



GLUE ANCHOR

page 113 <

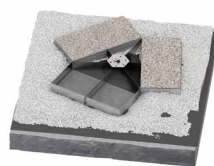

AOS01 + BLOCK

page 127 <



AOS01 + BLOCK

page 127 <



GREEN POINT

page 111 <

# WING

## ANCHOR POINT FOR WORK AT HEIGHT AND IN SUSPENSION

### SOLID

Extremely robust and reliable.

### VERSATILE

Can be used both for suspended work (1 person) and for protection against falls from height (3 people).

### MULTIPURPOSE

With three different versions of two materials and in three different colours, you will always find the right product for every application and environmental condition.



LOAD DIRECTION



TYPES OF APPLICATION

▼ Single WING anchorage points installed for use in suspension for the maintenance of a church dome.

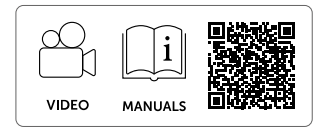

## ■ FIELDS OF APPLICATION

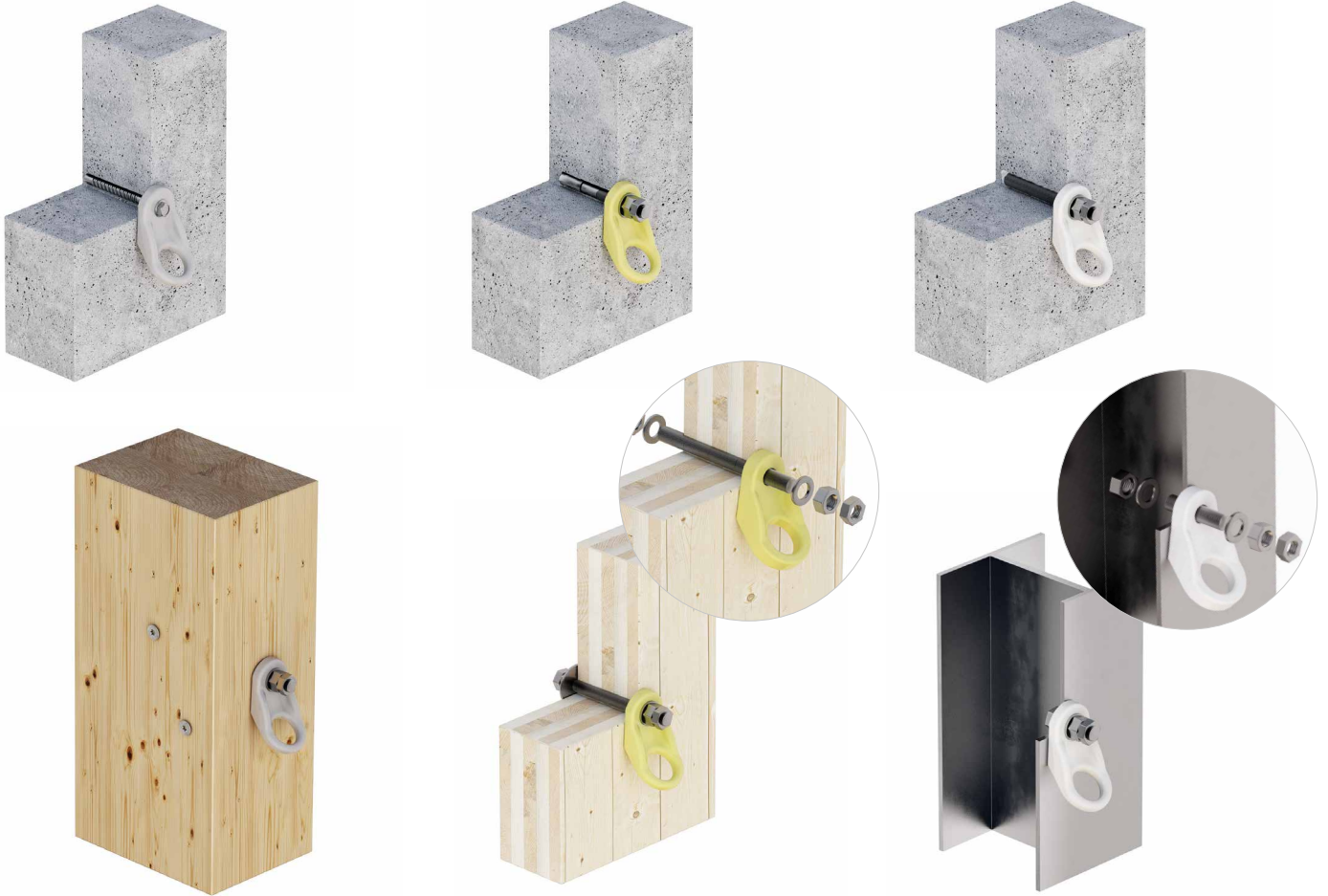

## ■ TECHNICAL DATA\*

substructure	minimum thickness	fasteners	substructure	minimum thickness	fasteners
GL24h	100 x 160 mm	VGS Ø11	C20/25	158 mm	AB1 Ø16
		XEPOX F			AB1A4 Ø16
		M16 rod + MUT + ULS			M16 + ULS + MUT (8.8/A2/A4)
	VIN-FIX				
CLT	100 mm	8.8 Ø16 rod + MUT + ULS			HYB-FIX
					SKR CE Ø16
S235JR				5 mm	EKS M16 + MUT + ULS (8.8/A2/A4)

\* The values indicated are the result of experimental tests carried out under the supervision of third parties in accordance with the standard referred to. For a calculation report with minimum distances according to the relevant standard requirements, the substructure must be checked by a qualified engineer before installation.

## ■ CODES AND DIMENSIONS

CODE	material	d <sub>1</sub>	B	H	L	pcs	
		[mm]	[mm]	[mm]	[mm]		
WING	S355J2 - zinc plated Fe/Zn 12μ + powder coated (RAL7032-grey)						
WINGY	S355J2 - zinc plated Fe/Zn 12μ + powder coated (RAL1016-yellow)	17	65	56	115	1	
WINGA4	AISI 316L stainless steel grade 1.4404						

# HOOK EVO

## ANCHOR POINT



### UNOBTRUSIVE

Under-tile fastening ensures a low visual impact in the roofing, for an aesthetically satisfactory result.

### ADJUSTABLE

Quick and easy installation using Ø8 HBS screws. The base plate with an increased number of holes allows the anchor to be mounted in different positions, depending on the type of roof tiles.



LOAD DIRECTION



TYPES OF APPLICATION

VIDEO

MANUALS

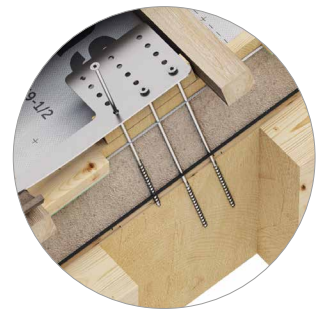

## TECHNICAL DATA\*

substructure	minimum thickness	fasteners
GL24h	100 x 100 mm	HBS Ø8

\* The values indicated are the result of experimental tests carried out under the supervision of third parties in accordance with the standard referred to. For a calculation report with minimum distances according to the relevant standard requirements, the substructure must be checked by a qualified engineer before installation.

## CODES AND DIMENSIONS

CODE	material	B [mm]	H [mm]	L [mm]	pcs
HOOKEVO	AISI 430 stainless steel grade 1.4016	132	79	490	1

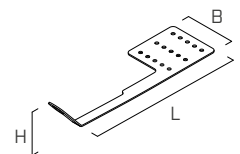

# HOOK EVO 2.0

## ANCHOR POINT



LOAD DIRECTION



TYPES OF APPLICATION



VIDEO

MANUALS

### UNOBTRUSIVE

Under-tile fastening ensures a low visual impact in the roofing, for an aesthetically satisfactory result.

### PRACTICAL

Fast, simple installation. The bottom plate allows the anchor to be assembled in different positions on both timber and concrete, depending on the height of the battens and the type of tiles.

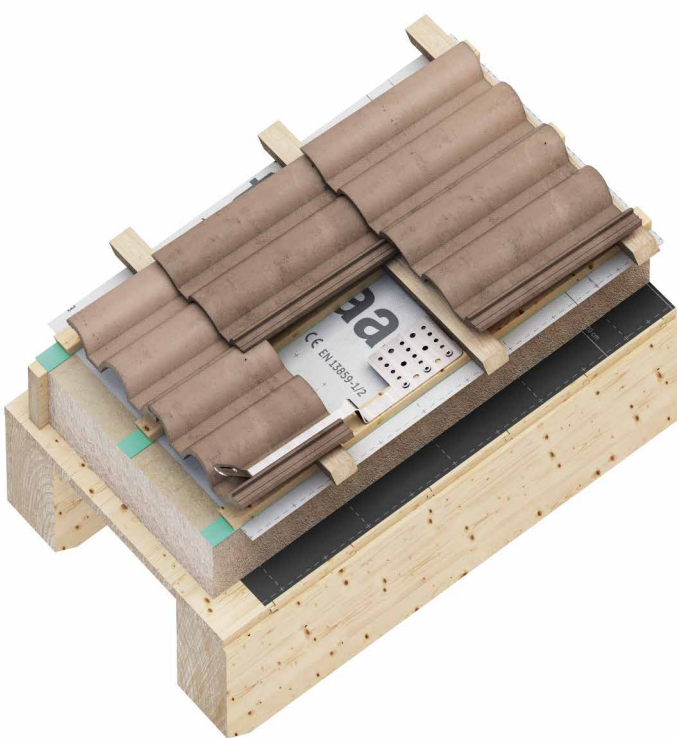

## TECHNICAL DATA\*

substructure	minimum thickness	fasteners	substructure	minimum thickness	fasteners
GL24h	80 X 100 mm + 18 mm of wooden plank	HBS Ø8	C20/25	100 mm	AB1 Ø10 M10 rod + ULS + MUT VIN-FIX/HYB-FIX

\* The values indicated are the result of experimental tests carried out under the supervision of third parties in accordance with the standard referred to. For a calculation report with minimum distances according to the relevant standard requirements, the substructure must be checked by a qualified engineer before installation.

## CODES AND DIMENSIONS

CODE	material	B [mm]	H [mm]	H <sub>1</sub> [mm]	L [mm]	pcs
HOOKEVO20	AISI 304 stainless steel grade 1.4301	132	20	92	520	5
HOOKEVO50	AISI 304 stainless steel grade 1.4301	132	50	122	520	5
HOOKEVO100	AISI 304 stainless steel grade 1.4301	132	100	172	520	5

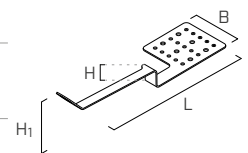

# HOOK SPIKE

## ANCHOR POINT WITH LADDER HOOK



### PRACTICAL

Shape designed to be able to attach a portable ladder to facilitate the operator's ascent on steep roofs.

### SAFE

Tested according to the standard directly on the substructure, it guarantees safety and freedom of movement in all directions.

### VERSATILE

Thanks to the three different heights of the plate, it is possible to choose and assemble the hook according to the type of tile installed on the roof.



LOAD DIRECTION



TYPES OF APPLICATION

▼ Installation of anchor point with HOOK SPIKE ladder hook on timber roofing.

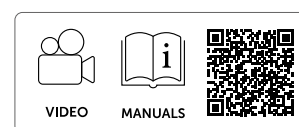

## ■ FIELDS OF APPLICATION

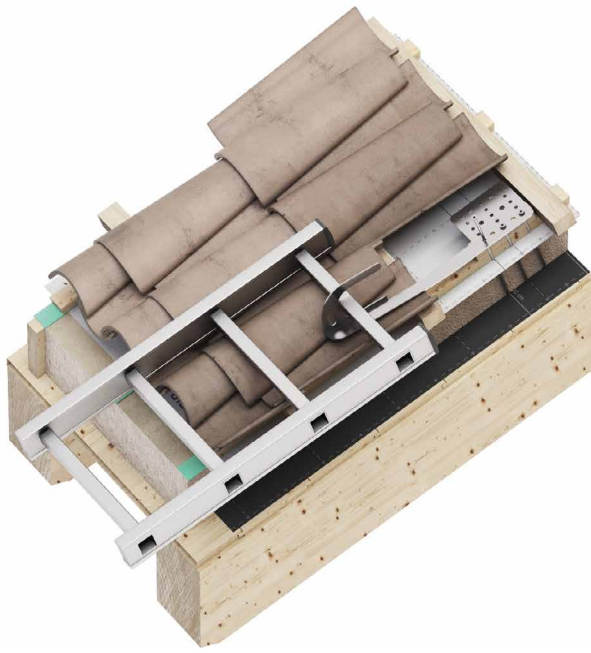

## ■ TECHNICAL DATA\*

substructure	minimum thickness	fasteners
 GL24h	100 x 100 mm	HBS Ø8 

\* The values indicated are the result of experimental tests carried out under the supervision of third parties in accordance with the standard referred to. For a calculation report with minimum distances according to the relevant standard requirements, the substructure must be checked by a qualified engineer before installation.

## ■ CODES AND DIMENSIONS

CODE	description	material	B [mm]	H [mm]	H <sub>1</sub> [mm]	L [mm]	pcs
HOOKS	anchor point with ladder hook	AISI 304 stainless steel grade 1.4301	132	-	112	520	1
HOOKS20	anchor point with ladder hook	AISI 304 stainless steel grade 1.4301	132	20	144	520	1
HOOKS50	anchor point with ladder hook	AISI 304 stainless steel grade 1.4301	132	50	174	520	1
HOOKSB	anchor point with brown ladder hook	AISI 304 stainless steel grade 1.4301	132	-	112	520	1
HOOKSB20	anchor point with brown ladder hook	AISI 304 stainless steel grade 1.4301	132	20	144	520	1
HOOKSB50	anchor point with brown ladder hook	AISI 304 stainless steel grade 1.4301	132	50	174	520	1
HOOKSA	anchor point with anthracite-coloured ladder hook	AISI 304 stainless steel grade 1.4301	132	-	112	520	1
HOOKSA20	anchor point with anthracite-coloured ladder hook	AISI 304 stainless steel grade 1.4301	132	20	144	520	1
HOOKSA50	anchor point with anthracite-coloured ladder hook	AISI 304 stainless steel grade 1.4301	132	50	174	520	1

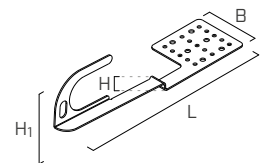

# LOOP

## ANCHOR POINT

### UNOBTRUSIVE

Under-tile fastening ensures a low visual impact, ideal for installation on roofs in historic centres.

### FAST

Fast and easy installation, with just two HBS Ø8 screws.



LOAD DIRECTION



TYPES OF APPLICATION

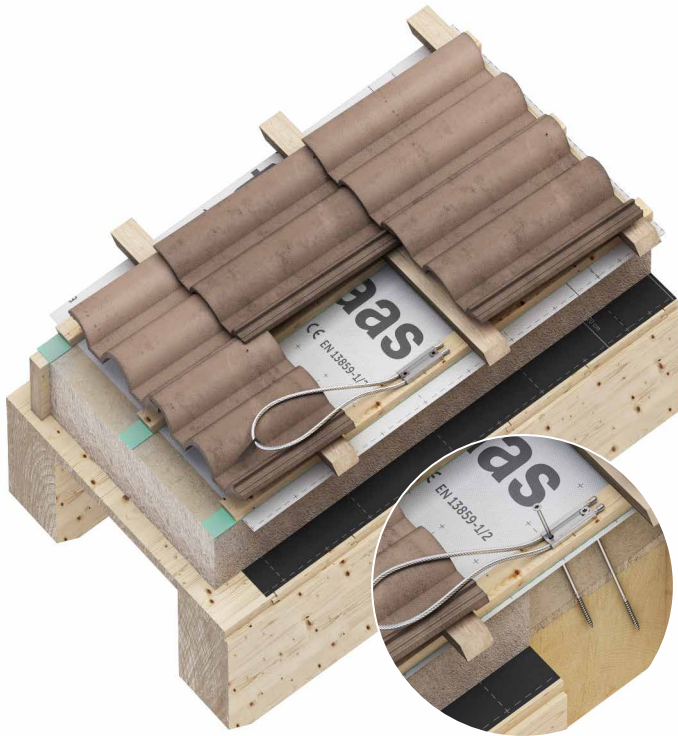

## TECHNICAL DATA\*

substructure	minimum thickness	fasteners
GL24h	100 x 100 mm	HBS Ø8

\* The values indicated are the result of experimental tests carried out under the supervision of third parties in accordance with the standard referred to. For a calculation report with minimum distances according to the relevant standard requirements, the substructure must be checked by a qualified engineer before installation.

substructure	minimum thickness	fastening + KRAKEN
C20/25	100 mm	M8 5.8 rod  + ULS + MUT VINIFIX/HYBIFIX

## CODES AND DIMENSIONS

CODE	material	B [mm]	H [mm]	L [mm]	pcs	
LOOP	AISI 316 stainless steel grade 1.4401 / EN AW 6060 T6	-	12	456	1	
LOOPXL	AISI 316 stainless steel grade 1.4401 / EN AW 6060 T6	-	12	756	1	
KRAKEN	AISI 430 stainless steel grade 1.4016 IIA	100	18	116	1	

CODE	description	page
PALMIFIX	universal counterplate	230
OMEGA	accessory for PALMIFIX	230

CODE	description	page
BEFPALMI	fastening set for PALMIFIX	231



# SLIM

## ANCHOR POINT FOR SMALL STRUCTURES



### ADJUSTABLE

Can be installed on small beams, with minimum dimensions of 38 x 68 mm with no limits on maximum width.

### MULTIPURPOSE

Can be used as single points or as a hook for ladders.



LOAD DIRECTION



TYPES OF APPLICATION





BEFSLIM2



BEFSLIM1

## TECHNICAL DATA\*

substructure	minimum thickness	fastening set
	114 x 68 mm	BEFSLIM1, BEFSLIM2 

\* The values indicated are the result of experimental tests carried out under the supervision of third parties in accordance with the standard referred to. For a calculation report with minimum distances according to the relevant standard requirements, the substructure must be checked by a qualified engineer before installation.

## CODES AND DIMENSIONS

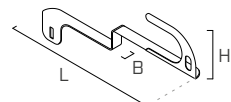
CODE	material	B [mm]	H [mm]	L [mm]	pcs	
SLIM	AISI 430 stainless steel grade 1.4016	30	173	500	5	

CODE	description	page	
BEFSLIM1	fastening set for SLIM	231	

CODE	description	page	
BEFSLIM2	height-adjustable fastening set for SLIM	231	

# KITE

## ANCHOR POINT



### PRACTICAL

Thanks to its lightweight and compact size, this anchor can be installed quickly and easily.

### SAFE

Laser cut from a single piece with no welding points, it improves safety in all its applications.

### VERSATILE

Ideal as an anchor point in multiple environments, it allows the operator to safely access.



LOAD DIRECTION



TYPES OF APPLICATION



VIDEO



MANUALS





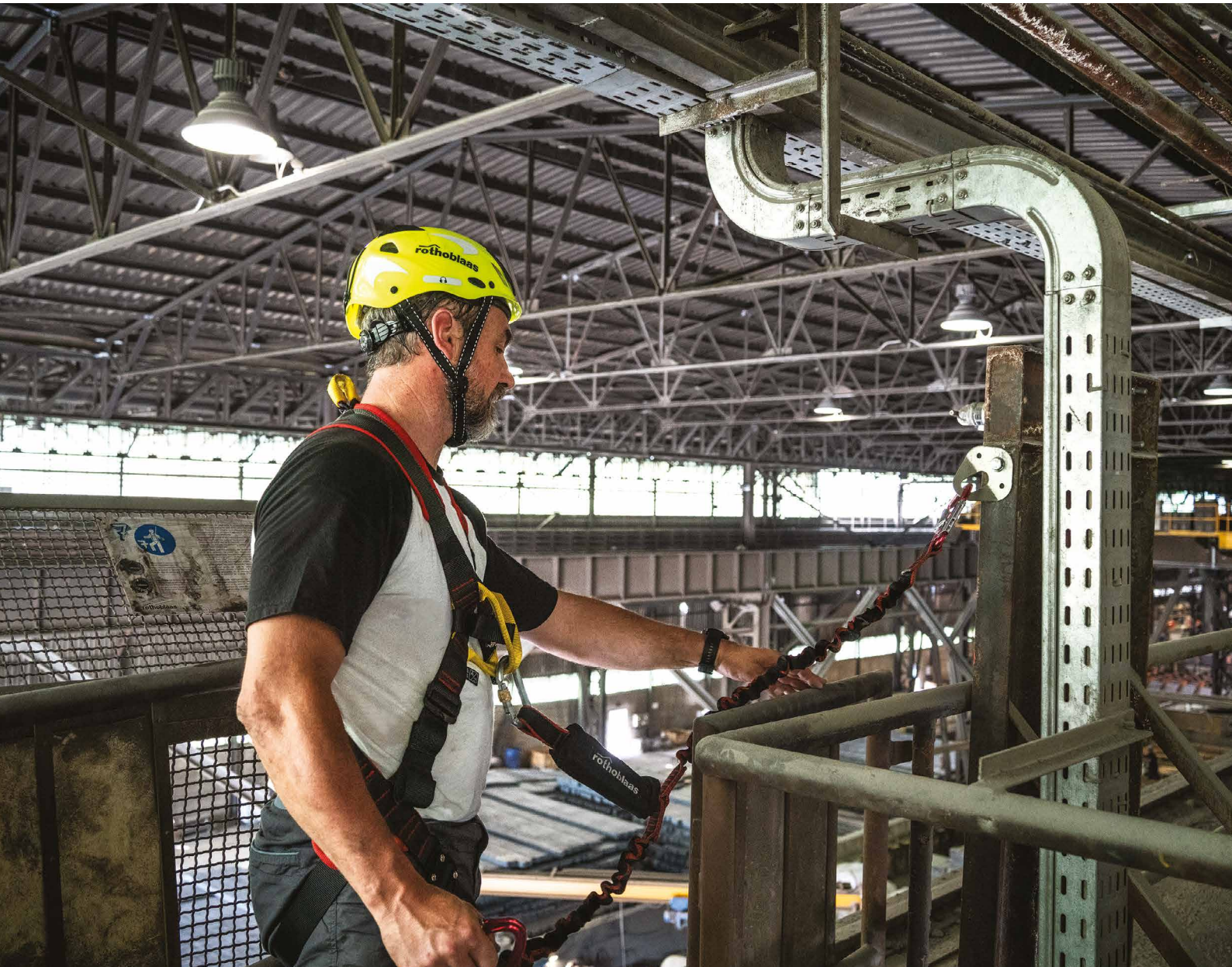







▼ *KITE anchor point installed in an industrial environment.*



## FIELDS OF APPLICATION



## TECHNICAL DATA\*

substructure	minimum thickness	fasteners	substructure	minimum thickness	fasteners
 GL24h	100 x 100 mm	2 x HBS Ø8  1x VGS Ø11 	 C20/25	140 mm	AB1 Ø12  M12 8.8 rod + ULS + MUT  VIN-FIX  HYB-FIX 
 S235JR	5 mm	EKS M12 8.8 + ULS + nut 			

\* The values indicated are the result of experimental tests carried out under the supervision of third parties in accordance with the standard referred to. For a calculation report with minimum distances according to the relevant standard requirements, the substructure must be checked by a qualified engineer before installation.

## CODES AND DIMENSIONS

CODE	material	B [mm]	L [mm]	pcs
KITE	AISI 430 stainless steel grade 1.4016	101	100	1

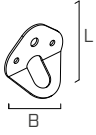

## ACCESSORIES

CODE	material
BEFKITE	KITE fastening set for timber 

# AOS

## ANCHOR POINT



### FUNCTIONAL

The 360° swivel eyelet allows the operator total freedom of movement.



### COMPLETE

Supplied in a handy kit complete with bolts and washers for installation.

### UNIVERSAL

The threaded rod available in various lengths allows the anchor to adapt to any type of timber, concrete and steel structure.



LOAD DIRECTION



TYPES OF APPLICATION



VIDEO

MANUALS

▼ AOS anchor points installed on a steel structure for securing an industrial environment.

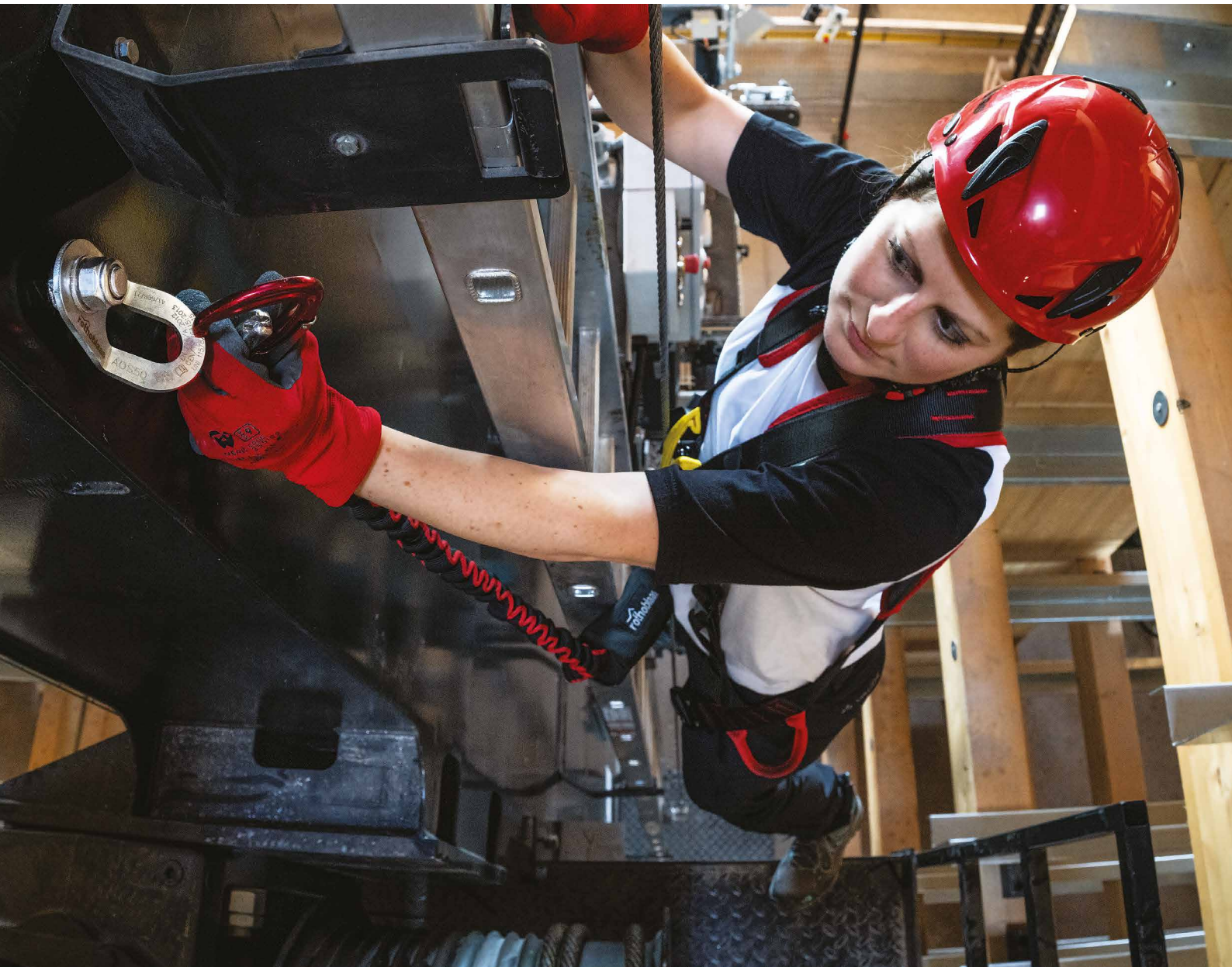

## FIELDS OF APPLICATION

OMEGA + PALMIFIX

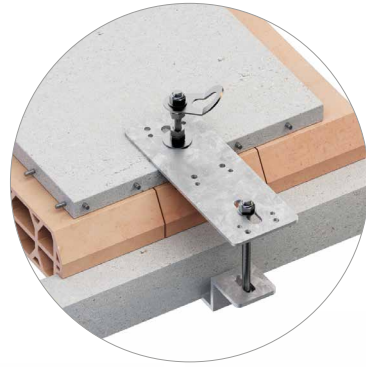

## TECHNICAL DATA\*

substructure	minimum thickness
GL24h	100 x 120 mm
S235JR	5 mm

substructure	minimum thickness	fasteners
C20/25	164 mm	VIN-FIX HYB-FIX

\* The values indicated are the result of experimental tests carried out under the supervision of third parties in accordance with the standard referred to. For a calculation report with minimum distances according to the relevant standard requirements, the substructure must be checked by a qualified engineer before installation.

## CODES AND DIMENSIONS

CODE	material	max. thickness of fixture [mm]	H [mm]	pcs
AOS50	AISI 304 stainless steel grade 1.4301	29	80	1
AOS130	AISI 304 stainless steel grade 1.4301	132	175	1
AOS200	AISI 304 stainless steel grade 1.4301	164	250	1
AOS300	AISI 304 stainless steel grade 1.4301	264	350	1
AOS400	AISI 304 stainless steel grade 1.4301	364	450	1
AOS500	AISI 304 stainless steel grade 1.4301	464	550	1

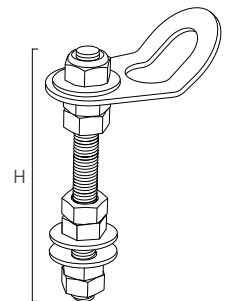

## ACCESSORIES

CODE	material	page
OMEGA	accessory for PALMIFIX	230

CODE	material	page
PALMIFIX	fixed counterplate	230

# SIANK

## ANCHOR POINT FOR STANDING SEAM METAL ROOFS



### EFFICIENT

The system is fixed to a single seam of the sheet using a few tools.

### UNOBTRUSIVE

Device fixed to the seam by means of a single clamp, without the need to drill holes in the metal sheet, guaranteeing its impermeability and durability.



LOAD DIRECTION



TYPES OF APPLICATION

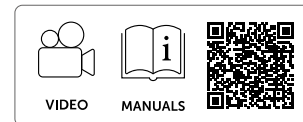

VIDEO

MANUALS



## TECHNICAL DATA\*

substructure	minimum thickness
 Fe	0,5 mm
 Al	0,7 mm
 Cu	0,5 mm

substructure	minimum thickness
 Zn - Ti	0,7 mm
 stainless steel	0.4 mm

\* The values indicated are the result of experimental tests carried out under the supervision of third parties in accordance with the standard referred to. For a calculation report with minimum distances according to the relevant standard requirements, the substructure must be checked by a qualified engineer before installation.

## CODES AND DIMENSIONS

CODE	description	material	B	H	L	pcs
			[mm]	[mm]	[mm]	
SIANK	anchor point for seaming 25 mm	AISI 304 stainless steel grade 1.4301	163	130	400	1
SIANK65	anchor point for seaming 65 mm	AISI 304 stainless steel grade 1.4301	104	163	400	1
SIANKA	anthracite-colour anchorage point for seaming 25 mm	AISI 304 stainless steel grade 1.4301	163	130	400	1
SIANKB	brown anchorage point for seaming 25 mm	AISI 304 stainless steel grade 1.4301	163	130	400	1

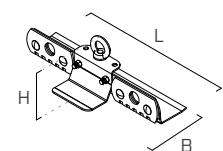

# GREEN POINT

## ANCHOR POINT WITH BALLASTS

> 80 kg/m <sup>2</sup> EN 795:2012 A	> 200 kg/m <sup>2</sup> EN 795:2012 A	> 200 kg/m <sup>2</sup> CEN/TS 16415:2013 
---	--	--

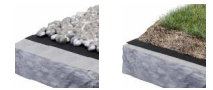

### FAST INSTALLATION

The system consists of few components which facilitate and speed up mounting.

### FUNCTIONAL

Support system which does not require the roofing to be drilled, thereby preventing thermal bridges and ensuring the structure waterproofing.



LOAD DIRECTION



TYPES OF APPLICATION

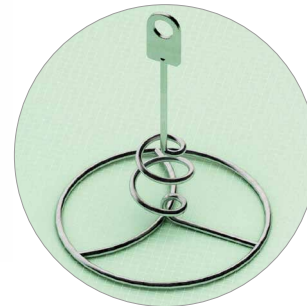
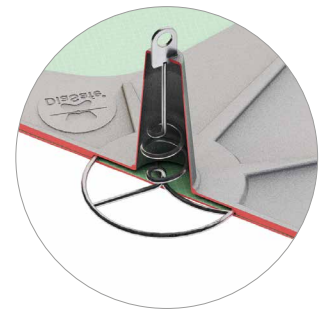
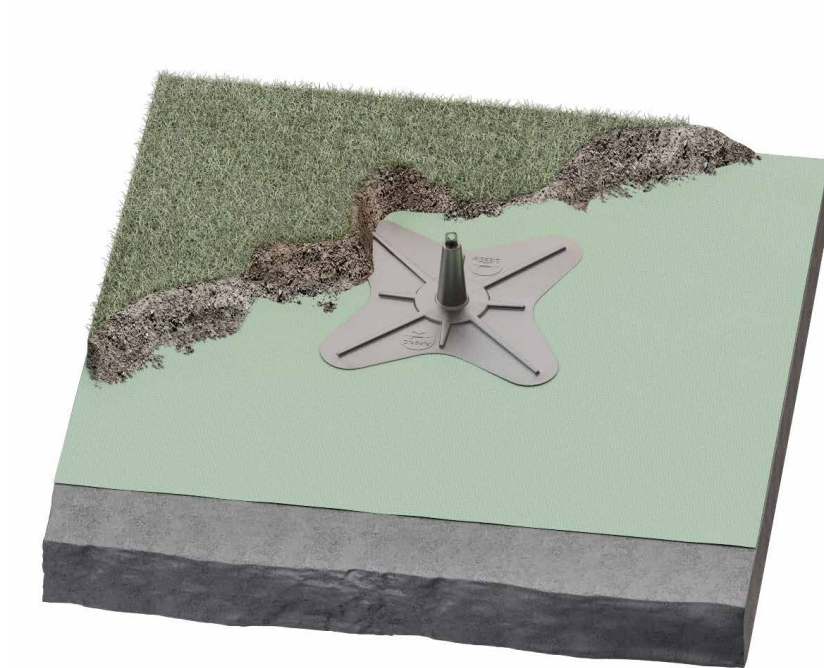

## TECHNICAL DATA\*

no. of operators	dimensions	material weight	total weight
	standard tarpaulin dimensions 3x3 m VLF non-woven geotextile	for ballast > 80 kg/m <sup>2</sup>	for each pole = 720 kg
	standard tarpaulin dimensions 3x3 m VLF non-woven geotextile	for ballast > 200 kg/m <sup>2</sup>	for each pole = 1800 kg

\* They are based on measurements from various test institutes and measurement laboratories. We reserve the right to make technical changes.

## CODES AND DIMENSIONS

CODE	description	material	d <sub>1</sub> [mm]	B [mm]	H [mm]	L [mm]	pcs	
DD01	anchor point internal element	AISI 316L stainless steel grade 1.4404	250	-	300	-	1	
DD03	tarpaulin with possibility of installing ballasts 3x3 m with external cone	glass fibre reinforced plastic (GFRP)	-	3000	-	3000	1	

# GLUE ANCHOR

## GLUED ANCHOR POINT FOR BITUMEN AND PVC ROOFS

### FUNCTIONAL

The application does not require any perforation of the PVC or bituminous sheathing, guaranteeing perfect waterproofing of the roof.

### FAST INSTALLATION

The system is quickly installed with very few tools.

### VERSATILE

Equipped with a 360° swivel eyelet to facilitate work operations.



TYPES OF APPLICATION

▼ *Single anchor point welded onto a bituminous layer for securing a flat roof.*





## ■ FIELDS OF APPLICATION

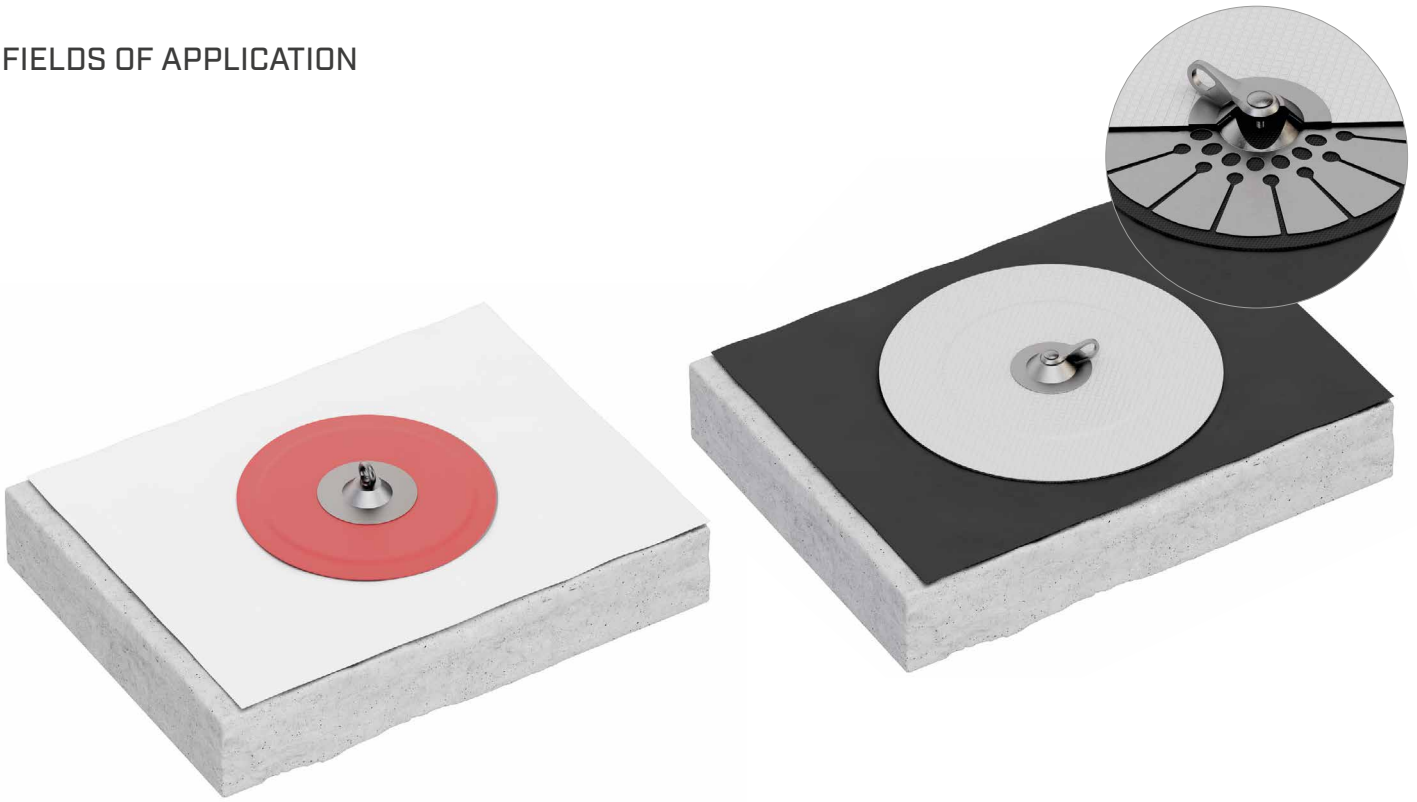

## ■ TECHNICAL DATA\*

	GLUEPVC	GLUEBIT
ambient temperature of use	-	min. -30° C / max. 90°C
substrate material requirement	-	ABB / SBS multilayer bitumen membrane with at least one polyester core PVC / polyester reinforced membrane
substrate tensile strength	≥ 900N/50 mm (EN 12311-2)	340 ± 20% N/50 mm
max. roof slope 15°	15°	15°
minimum surface around the anchor point (from the centre)	1,80 m	2 m
other substrate requirements	The substrate must be clean, free of dust, moss and algae. Of course, the substrate must be completely dry	1. Mechanically fastened (MF) with a minimum of 3 fasteners per m <sup>2</sup> 2. Ballasted with gravel at least 40 mm thick (approx. 60 kg/m <sup>2</sup> ) 3. Partially glued (50% of total surface area) to a mechanically fixed bituminous roof waterproofing system

\* The values indicated are derived from experimental tests carried out under the supervision of third party organisations according to the referenced standard. For a calculation report with minimum distances, according to the referenced normative requirements, the substructure must be verified by a qualified engineer before installation.

## ■ CODES AND DIMENSIONS

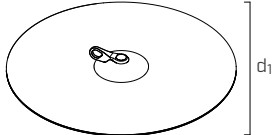
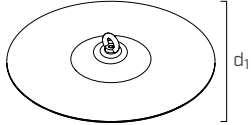
CODE	material	d <sub>1</sub> [mm]	pcs	
GLUEBIT	glued anchor point for bitumen roof with swivel eyelet	700	1	
GLUEPVC	glued anchor point for PVC roofs	520	1	
GLUEBITGRA	gravel anchor system protection	-	1	

# WING 2

## ANCHOR POINT

A4  
AISI 316

EN  
795 - A



### UNOBTRUSIVE

Very compact device that provides an anchorage point for an operator.

### PRACTICAL

With its light weight, it is ideal as an anchor point for the safety rope during suspension work.

## CODES AND DIMENSIONS

CODE	material	weight [g]	anchor system diameter*	pcs
WING2	stainless steel AISI 316	44	M12	1

\* The values indicated are the result of experimental tests carried out under the supervision of third parties in accordance with the standard referred to. For a calculation report with minimum distances according to the relevant standard requirements, the substructure must be checked by a qualified engineer before installation.

# MOBILE

## MOBILE ANCHOR POINT

EN  
795 - B

CE



### REMOVABLE

It can be assembled and disassembled easily and quickly, to safely ensure temporary access to the roofing.

### FUNCTIONAL

It can be temporarily installed on doors, windows and inclined skylights, with no structural damage.

## CODES AND DIMENSIONS

CODE	material	L [mm]	B [mm]	H [mm]	weight [kg]	pcs
MOBILE	EE30 aluminium	1450	770	175	6,7	1

The values indicated are the result of experimental tests carried out under the supervision of third parties in accordance with the standard referred to. For a calculation report with minimum distances according to the relevant standard requirements, the substructure must be checked by a qualified engineer before installation.



# ROD

## ANCHOR POINT FOR STEEL STRUCTURES



### PRACTICAL

Thanks to its compact size, this anchor can be installed quickly and easily.

### VERSATILE

It can be assembled on tubular and box-type steel structures of different sizes.



## CODES AND DIMENSIONS

CODE	material	dimensions [mm]	anchor point diameter [mm]	weight [kg]	pcs
ROD	stainless steel	208 x 97 x 75-140	17	2,5	1

The values indicated are the result of experimental tests carried out under the supervision of third parties in accordance with the standard referred to. For a calculation report with minimum distances according to the relevant standard requirements, the substructure must be checked by a qualified engineer before installation.

# CARRIER

## SLIDING ANCHOR FOR STEEL STRUCTURES



### FUNCTIONAL

Thanks to the integrated rollers, the device slides smoothly along the entire steel structure.

### PRACTICAL

Quick and easy to install anchorage on steel beams with different widths, from 75 to 120 mm.



## CODES AND DIMENSIONS

CODE	material	dimensions [mm]	B [mm]	H [mm]	weight [kg]	pcs
CARRIER	zinc plated steel	195 x 176 x 212	50-120	60	5,2	1

The values indicated are the result of experimental tests carried out under the supervision of third parties in accordance with the standard referred to. For a calculation report with minimum distances according to the relevant standard requirements, the substructure must be checked by a qualified engineer before installation.



# AOS01

## ANCHOR POINT

### FREEDOM OF MOVEMENT, SAFETY AND DURABILITY.

AOS01 is the universal device that allows you to make anchor points with all Rothoblaas supports. The 360° swivel eyelet provides total freedom of movement, ensuring reduced visual impact once installed on the roof. Completely made of stainless steel, AOS01 resists corrosion and atmospheric agents, maintaining its effectiveness over time.

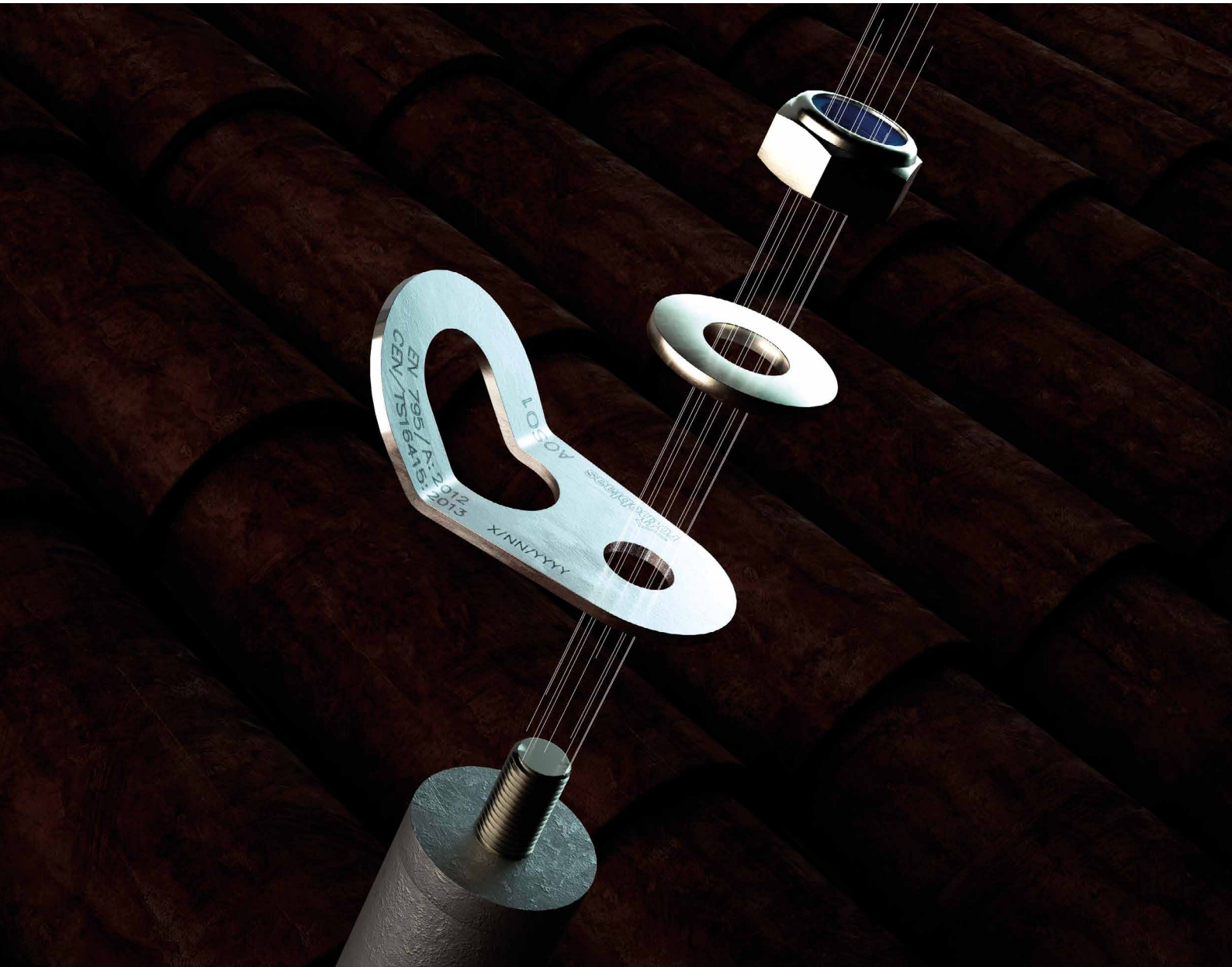

# AOS01 | overview

## AOS01 + TOWER/TOWER A2

ANCHOR POINT FOR TIMBER, CONCRETE AND STEEL ROOFS

EAC



➤ PAGE 118

## AOS01 + TOWER XL

ANCHOR POINT WITH INCREASED BOTTOM PLATE FOR TIMBER, STEEL AND CONCRETE ROOFS

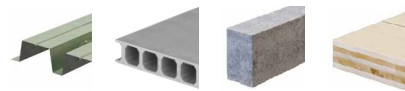

➤ PAGE 120

## AOS01 + SHIELD

ANCHOR POINT FOR TRAPEZOIDAL METAL ROOFS

EAC



➤ PAGE 122

## AOS01 + SHIELD 2

ANCHOR POINT FOR TRAPEZOIDAL METAL ROOFS

EAC



➤ PAGE 123

## AOS01 + SIANK 4

ANCHOR POINT FOR STANDING SEAM METAL ROOFS

EAC



➤ PAGE 124

## AOS01 + SEAMO

ANCHOR POINT FOR ROUND SEAM METAL ROOFS



➤ PAGE 125

## AOS01 + COPPO

ANCHOR POINT FOR ROOFS WITH FAUX TILES

EAC



➤ PAGE 126

## AOS01 + BLOCK

ANCHOR POINT WITH BALLAST FOR FLAT ROOFS

CE



➤ PAGE 127

# AOS01 + TOWER/TOWER A2



ANCHOR POINT FOR TIMBER,  
CONCRETE AND STEEL ROOFS

EN 795:2012 A	CEN/TS 16415:2013 	UNI 11578:2015 A 	AS/NZS 5532:2013 	AS/NZS 1891.4:2009 
------------------	--------------------------	----------------------------	-------------------------	---------------------------

## PRACTICAL

Support height is between 300 and 600 mm to adapt to different roofing thicknesses.

## EFFECTIVE

Device with controlled deformation to limit load transfer to the structure.

## UNOBTRUSIVE

Small-sized cylindrical system, minimizes the visual impact on the roofing.



LOAD DIRECTION

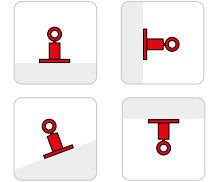

TYPES OF APPLICATION

 VIDEO	 MANUALS	 TOWER	 TOWER A2
-----------	-------------	-----------	--------------

▼ Anchor point AOS01 installed on TOWER support for maintenance of industrial sheet metal roof.

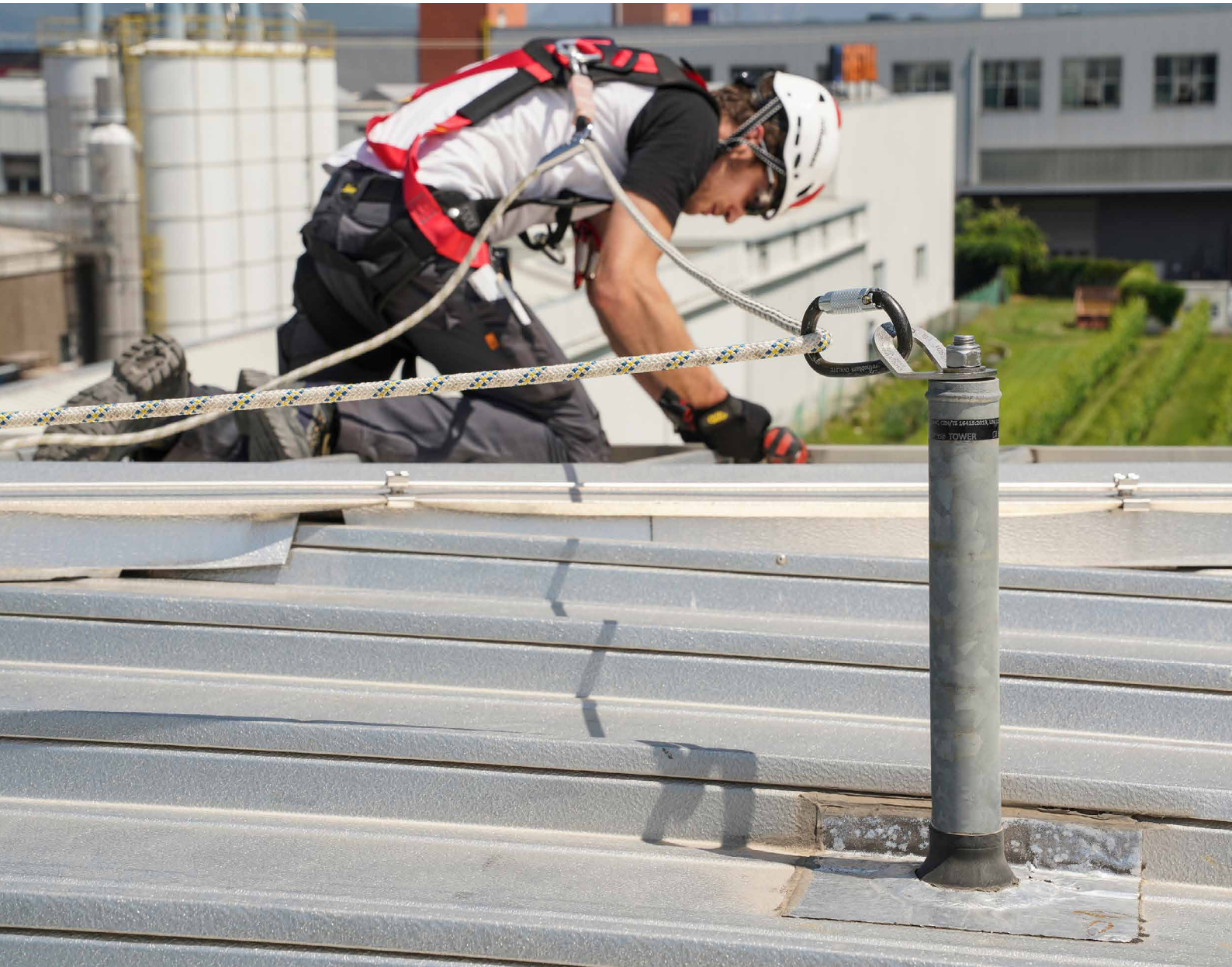

## ■ FIELDS OF APPLICATION



## ■ TECHNICAL DATA\*

substructure	minimum thickness	fasteners	substructure	minimum thickness	fasteners
GL24h	160 x 160 mm	VGS Ø9	C20/25	140 mm	AB1 Ø12
CLT	200 mm	VGS Ø9			rod Ø12
S235JR	6 mm	EKS+ULS+MUT			VIN-FIX HYB-FIX

\* The values indicated are the result of experimental tests carried out under the supervision of third parties in accordance with the standard referred to. For a calculation report with minimum distances according to the relevant standard requirements, the substructure must be checked by a qualified engineer before installation.

## ■ TOWER/TOWER A2 | CODES AND DIMENSIONS

**A2**  
AISI 304

CODE	material	d <sub>1</sub> [mm]	B [mm]	H [mm]	L [mm]	pcs	
TOWER300	S235JR zinc plated steel	48	150	300	150	1	
TOWERA2300	AISI 304 stainless steel grade 1.4301						
TOWER400	S235JR zinc plated steel						
TOWERA2400	AISI 304 stainless steel grade 1.4301						
TOWER500	S235JR zinc plated steel						
TOWERA2500	AISI 304 stainless steel grade 1.4301						
TOWER600	S235JR zinc plated steel						
TOWER22500	S235JR zinc plated steel	-	60	-	98	1	
AOS01	AISI 304 stainless steel grade 1.4301						

## COMPLEMENTARY PRODUCTS

CODE	description	page	CODE	description	page
TOWERPEAK	adaptor for double layer ridge piece	228	TOPLATE	counterplate	230
TOWERSLOPE	fastening guide for rafter	228	BEF201VGS	fastening set	231
TOWLATEVO	TOWER fastening to the wall	229	MANPOST1	adhesive sealing sleeve for outdoors	232
			MANPOST2	EPDM sleeve	232
			MANEPDM	EPDM sleeve	232
			MANLEAD	lead waterproofing cover	232

# AOS01 + TOWER XL

## ANCHOR POINT WITH INCREASED BOTTOM PLATE FOR TIMBER, STEEL AND CONCRETE ROOFS

### PRACTICAL

Support height between 300 and 800 mm to adapt to different roofing thicknesses.

### SAFE

The enlarged bottom plate allows for the distribution of actions resulting from the anchoring devices over a wider area.

### EFFECTIVE

Device with controlled deformation, it dissipates a part of the energy built up during a fall to limit the load transferred to the fastening and the structure.



LOAD DIRECTION



TYPES OF APPLICATION



VIDEO



MANUALS



▼ Anchorage point AOS01 installed on TOWER XL support for maintenance of CLT flat roof.





## FIELDS OF APPLICATION



## TECHNICAL DATA\*

substructure	minimum thickness	fasteners
CLT	100 mm	VGS Ø11
C45/55	30 mm	BEFTOWERXL1
	0,75 mm	set TRAPO

substructure	minimum thickness	fasteners
C20/25	110 mm	AB7 Ø10 rod Ø10 VIN-FIX SKR CE Ø10

\* The values indicated are the result of experimental tests carried out under the supervision of third parties in accordance with the standard referred to. For a calculation report with minimum distances according to the relevant standard requirements, the substructure must be checked by a qualified engineer before installation.

## TOWER XL | CODES AND DIMENSIONS

CODE	material	d <sub>1</sub> [mm]	B [mm]	H [mm]	L [mm]	pcs
TOWERXL300	S235JR zinc plated steel	48	350	300	350	1
TOWERXL400	S235JR zinc plated steel	48	350	400	350	1
TOWERXL500	S235JR zinc plated steel	48	350	500	350	1
TOWERXL600	S235JR zinc plated steel	48	350	600	350	1
TOWERXL700	S235JR zinc plated steel	48	350	700	350	1
TOWERXL800	S235JR zinc plated steel	48	350	800	350	1
AOS01	AISI 304 stainless steel grade 1.4301	-	60	-	98	1

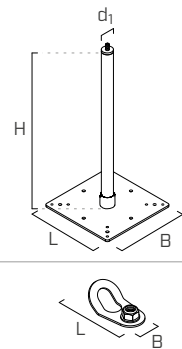

## COMPLEMENTARY PRODUCTS

CODE	description	page
MANPOST1	adhesive sealing sleeve for outdoors	232
MANPOST2		
MANEPDM	EPDM sleeve	232
MANLEAD	lead waterproofing cover	232



CODE	description	page
TRAPO	support for trapezoidal steel deck	230
BEFTOWERXL1	fastening set for aerated cement	231

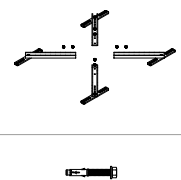

# AOS01 + SHIELD

## ANCHOR POINT FOR TRAPEZOIDAL METAL ROOFS



### UNOBTRUSIVE

It ensures a reduced visual impact thanks to its small size.

### PACKAGING

Supplied complete with mounting rivets and cellular rubber seals for perfect waterproofing.



LOAD DIRECTION



TYPES OF APPLICATION

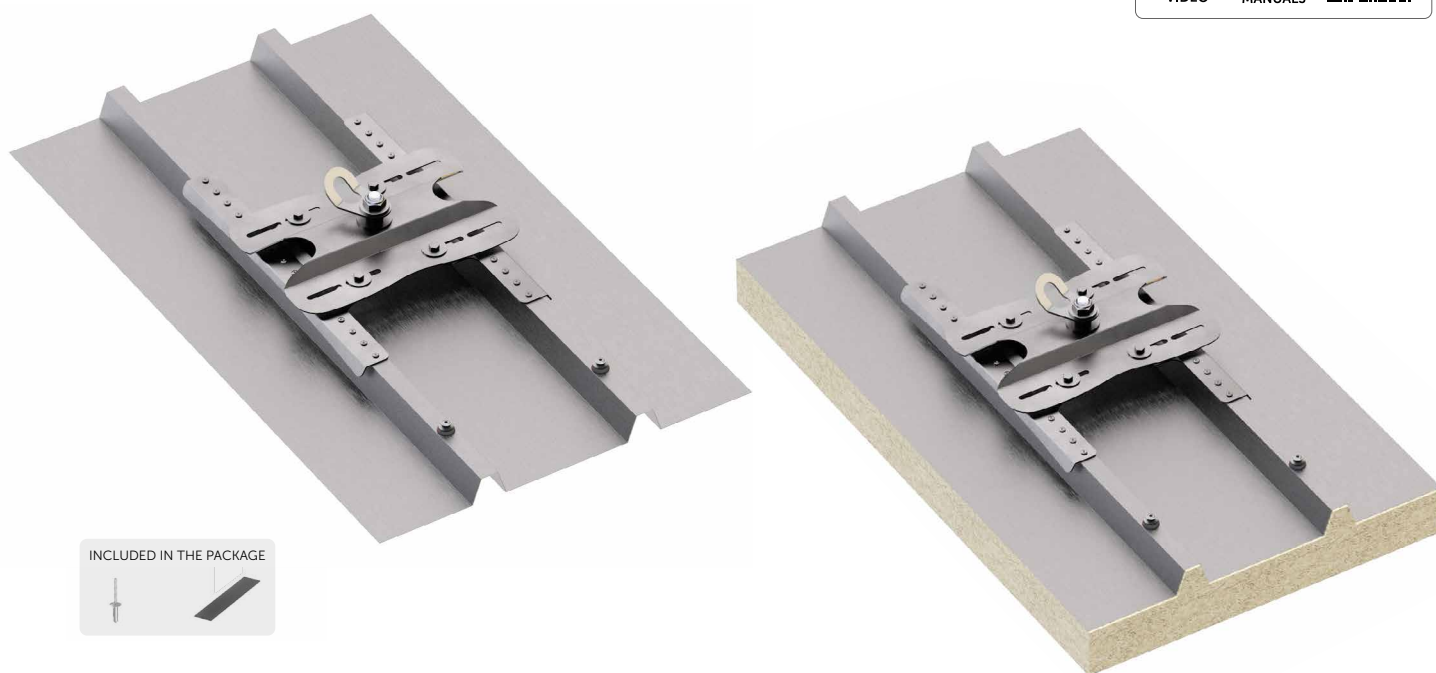
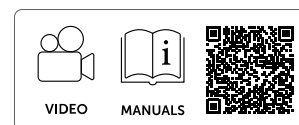

INCLUDED IN THE PACKAGE



## TECHNICAL DATA\*

substructure	minimum thickness	fastening systems included	substructure	minimum thickness	fastening systems included
Fe	0.4 mm	rivet 6,3 x 20,2 mm with EPDM washer (x 32)	Al	0,6 mm	rivet 6,3 x 20,2 mm with EPDM washer (x 32)
Fe	0.4 mm		Al	0,6 mm	

\* The values indicated are the result of experimental tests carried out under the supervision of third parties in accordance with the standard referred to. For a calculation report with minimum distances according to the relevant standard requirements, the substructure must be checked by a qualified engineer before installation.

## SHIELD | CODES AND DIMENSIONS



CODE	material	B	H	L	pcs	
		[mm]	[mm]	[mm]		
SHIELD	AISI 304 stainless steel grade 1.4301	180-420	85	476	1	
AOS01	AISI 304 stainless steel grade 1.4301	60	-	98	1	
RIV6320	rivets 6,3 x 20,2 mm with EPDM washer	-	-	-	33	

# AOS01 + SHIELD 2

## ANCHOR POINT FOR TRAPEZOIDAL METAL ROOFS



### FAST

Easy installation because it is configured as a single plate.

### COMPLETE

The package includes fasteners and cellular rubber seals, to ensure waterproofing.



LOAD DIRECTION



TYPES OF APPLICATION

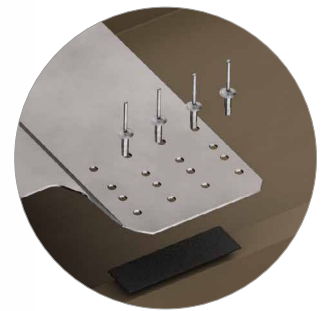
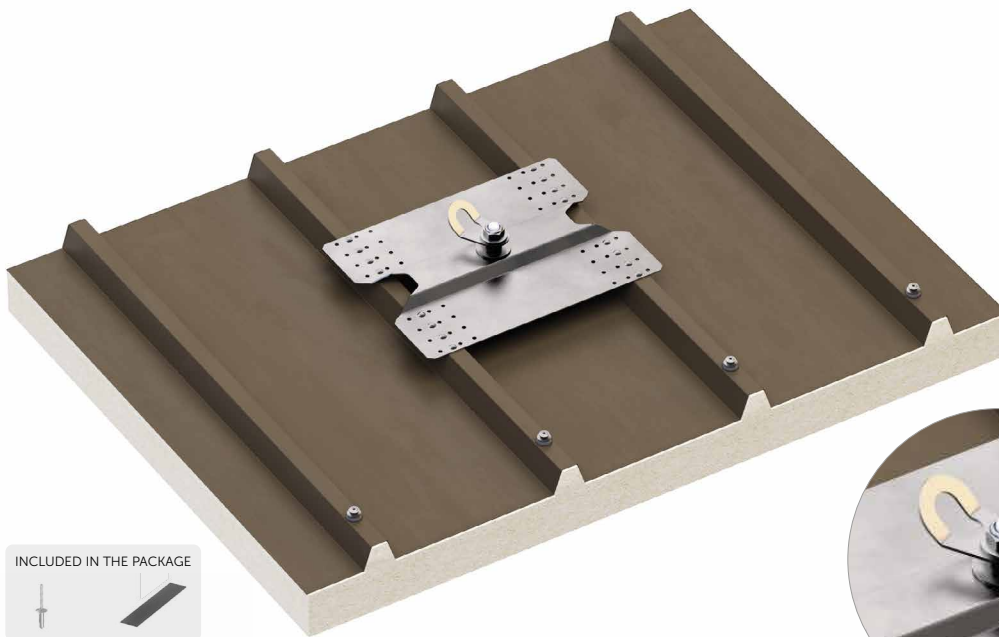

## TECHNICAL DATA\*

substructure	minimum thickness	fastening systems included
Fe	0,5 mm	rivet 6,3 x 20,2 mm with EPDM washer (x 16)
Fe	0,5 mm	

substructure	minimum thickness	fastening systems included
Al	1 mm	rivet 6,3 x 20,2 mm with EPDM washer (x 16)
Al	0,7 mm	

\* The values indicated are the result of experimental tests carried out under the supervision of third parties in accordance with the standard referred to. For a calculation report with minimum distances according to the relevant standard requirements, the substructure must be checked by a qualified engineer before installation.

## SHIELD 2 | CODES AND DIMENSIONS



CODE	material	B	H	L	pcs	
		[mm]	[mm]	[mm]		
SHIELD2	AISI 304 stainless steel grade 1.4301	420	65	322	1	
AOS01	AISI 304 stainless steel grade 1.4301	60	-	98	1	
RIV6320	rivets 6,3 x 20,2 mm with EPDM washer	-	-	-	33	

# AOS01 + SIANK 4



## ANCHOR POINT FOR STANDING SEAM METAL ROOFS

### ROBUST

Fixed on two crimps for improved resistance.

### HIGH PERFORMANCE

Up to four workers can be attached.

### SAFETY

Installation does not require the sheet metal to be drilled, thanks to the gripper which distributes the load over the double seam, thus ensuring the integrity of the building envelope.





LOAD DIRECTION



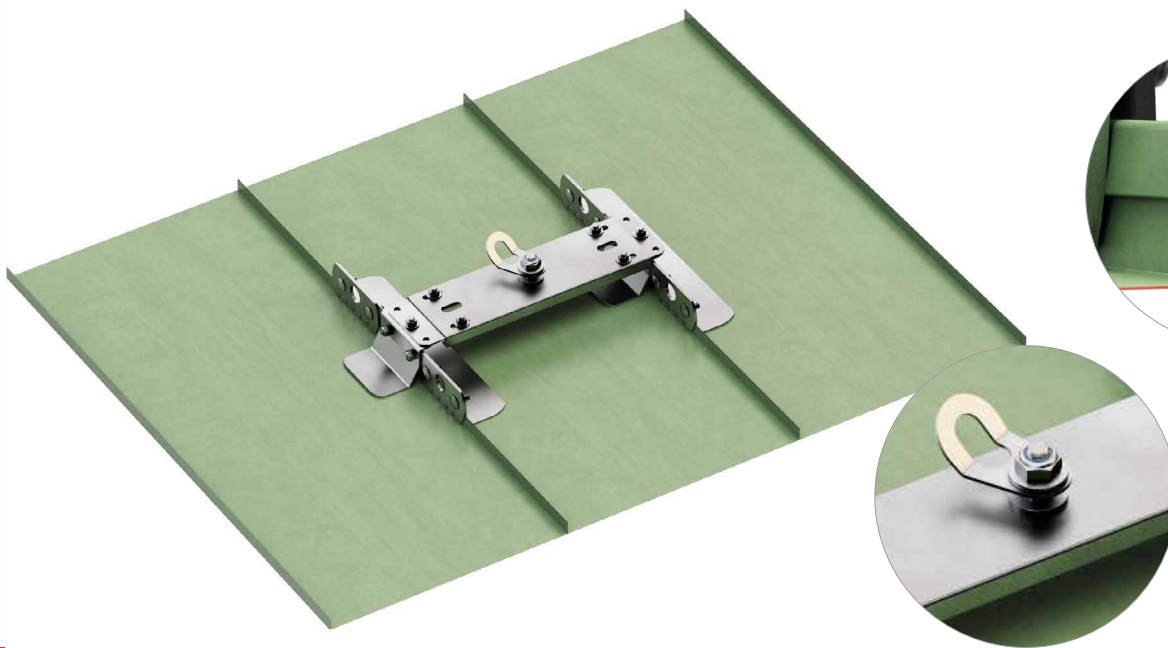

TYPES OF APPLICATION



## TECHNICAL DATA\*

substructure	minimum thickness
 Fe	0,5 mm
 Al	0,7 mm
 Cu	0,5 mm

substructure	minimum thickness
 Zn - Ti	0,7 mm
 stainless steel	0.4 mm

\* The values indicated are the result of experimental tests carried out under the supervision of third parties in accordance with the standard referred to. For a calculation report with minimum distances according to the relevant standard requirements, the substructure must be checked by a qualified engineer before installation.

## SIANK 4 | CODES AND DIMENSIONS



CODE	material	B [mm]	H [mm]	L [mm]	pcs
SIANK4	AISI 304 stainless steel grade 1.4301	430-600	90	400	1
SIANK465	AISI 304 stainless steel grade 1.4301	430-600	113	400	1
AOS01	AISI 304 stainless steel grade 1.4301	60	-	98	1

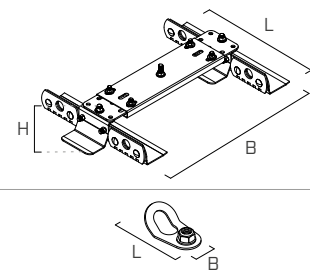

# AOS01 + SEAMO

## ANCHOR POINT FOR ROUND SEAM METAL ROOFS



### SIMPLE

Fastened to the seam with four clamps, without the need to make openings in the sheet metal.

### ROBUST

Fixed on two round crimps for improved resistance.





LOAD DIRECTION

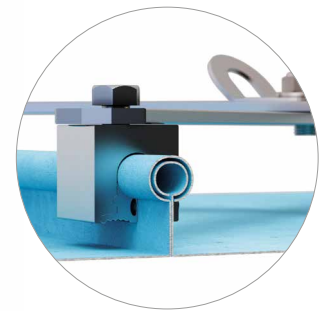
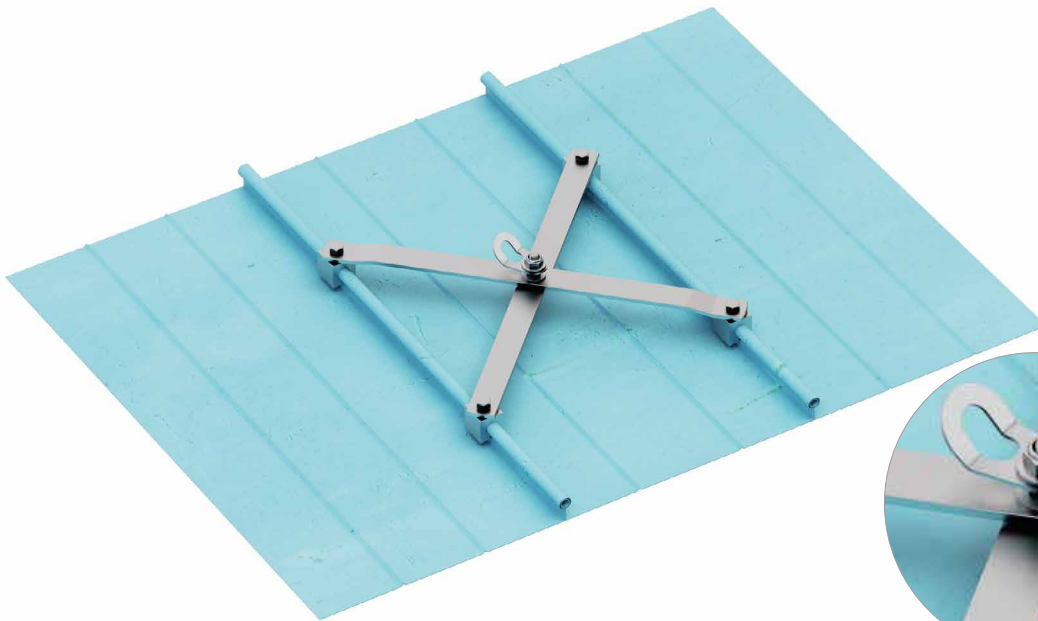

TYPES OF APPLICATION





## TECHNICAL DATA\*

substructure	minimum thickness	substructure	minimum thickness
 Fe ALUFALZ, INTERFALZ, BEMO ROOF, KALZIP	0,6 mm	 Al ALUFALZ, INTERFALZ, BEMO ROOF, KALZIP	0,8 mm

\* The values indicated are the result of experimental tests carried out under the supervision of third parties in accordance with the standard referred to. For a calculation report with minimum distances according to the relevant standard requirements, the substructure must be checked by a qualified engineer before installation.

## SEAMO | CODES AND DIMENSIONS

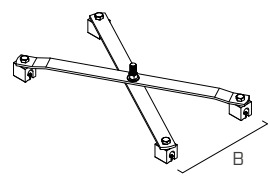

CODE	material	B [mm]	H [mm]	L [mm]	pcs	
SEAMO	AISI 304 stainless steel grade 1.4301	305-500	-	-	1	
AOS01	AISI 304 stainless steel grade 1.4301	60	-	98	1	

# AOS01 + COPPO



## ANCHOR POINT FOR ROOFS WITH FAUX TILES



### FAST

Easy installation because it is configured as a single plate.

### COMPLETE

The package includes fasteners and cellular rubber seals, to ensure waterproofing.



LOAD DIRECTION



TYPES OF APPLICATION

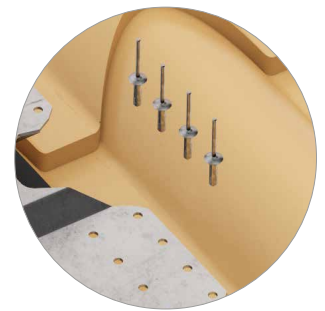

## TECHNICAL DATA\*

substructure	minimum thickness	fastening systems included	substructure	minimum thickness	fastening systems included
Fe	0,5 mm	rivet 6,3 x 20,2 mm with EPDM washer (x 24)	Al	0,7 mm	rivet 6,3 x 20,2 mm with EPDM washer (x 24)

\* The values indicated are the result of experimental tests carried out under the supervision of third parties in accordance with the standard referred to. For a calculation report with minimum distances according to the relevant standard requirements, the substructure must be checked by a qualified engineer before installation.

## COPPO | CODES AND DIMENSIONS



CODE	material	B	H	L	pcs
		[mm]	[mm]	[mm]	
COPPO	AISI 304 stainless steel grade 1.4301	420	65	322	1
AOS01	AISI 304 stainless steel grade 1.4301	60	-	98	1
RIV6320	rivets 6,3 x 20,2 mm with EPDM washer	-	-	-	33

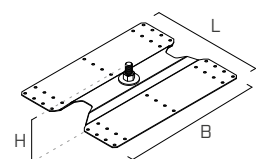

# AOS01 + BLOCK



## ANCHOR POINT WITH BALLAST FOR FLAT ROOFS

### WITHOUT PERFORATIONS

It is designed for installation on flat roofs, and does not require to drill the roof covering, avoiding thermal bridges and preserving the waterproofing layer of the structure.

### FLAT ROOFS

Designed for flat roofs with inclines up to 5° with PVC or bituminous final covering, with or without gravel.

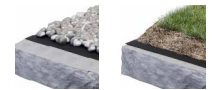

LOAD DIRECTION



TYPES OF APPLICATION

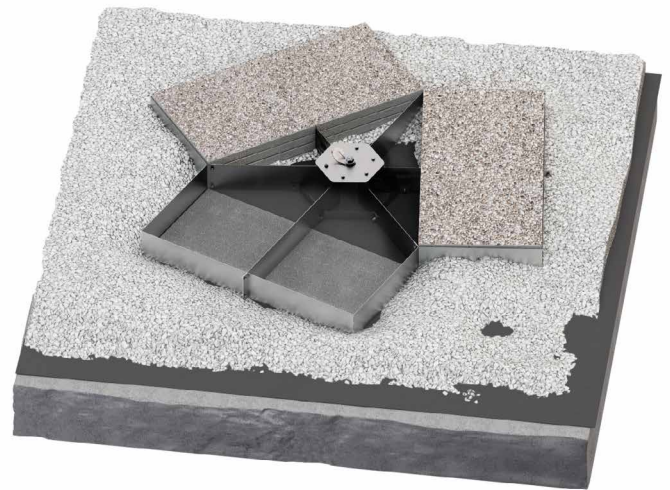

## BLOCK | CODES AND DIMENSIONS



CODE	material	B [mm]	H [mm]	L [mm]	pcs
BLOCK	AISI 304 stainless steel grade 1.4301	1870	165	1645	1
AOS01	AISI 304 stainless steel grade 1.4301	60	-	98	1

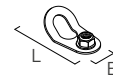
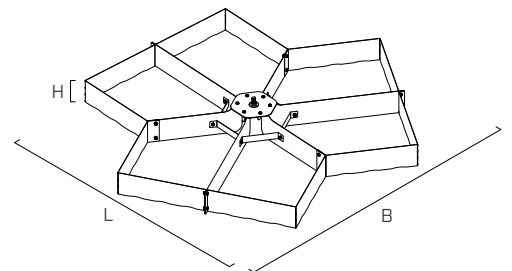

\* The values indicated are the result of experimental tests carried out under the supervision of third parties in accordance with the standard referred to. For a calculation report with minimum distances according to the relevant standard requirements, the substructure must be checked by a qualified engineer before installation.

### COMPLEMENTARY PRODUCTS

CODE	description	B [mm]	L [mm]	s [mm]	pcs
BLOCKMAT	BLOCKMAT mats not included in the supply of the BLOCK item (3 pieces per BLOCK are required) it can be ordered separately.	550	1050	6	1

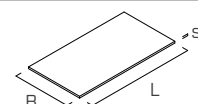





# COLLECTIVE PROTECTION

# COLLECTIVE PROTECTION

# COLLECTIVE PROTECTION

## PERMANENT RAILING BARRIERS

---

<b>GUARD</b> PERMANENT ALUMINIUM RAILINGS .....	134
<b>GUARD H</b> HORIZONTAL FASTENING RAILING .....	136
<b>GUARD V/GUARD VD</b> RAILING VERTICAL AND VERTICAL SPACED FASTENING .....	137
<b>GUARD W</b> SELF-SUPPORTING RAILING .....	138
<b>GUARD Z</b> A Z FASTENING RAILING .....	139
<b>GUARD M</b> RAILING FASTENING ON TRAPEZOIDAL METAL ROOF .....	140
<b>GUARD   COMPONENTS</b> .....	141

## FIXED LADDERS

---

<b>LADSTEP</b> CAGED LADDERS .....	144
<b>LADSTEP   BASIC COMPONENTS</b> .....	146
<b>LADSTEP   ACCESSORY COMPONENTS</b> .....	148

## FIXED FALL PROTECTION NETS

---

<b>SAFENET</b> CUSTOMIZABLE HORIZONTAL FALL PROTECTION NET .....	150
<b>ROLLNET</b> HORIZONTAL FIXED FALL PROTECTION NET .....	152

## WALKWAYS AND OVERPASSES

---

<b>WALKSAFE</b> WALKWAYS .....	154
<b>OVERLANE</b> OVERPASS WALKWAY .....	156

## TEMPORARY RAILING BARRIERS

---

<b>EDGE TEMP 1</b> TEMPORARY RAILING ROOF SIDE .....	158
<b>EDGE TEMP 2</b> TEMPORARY RAILING FRONT COVER .....	158
<b>EDGE TEMP 3</b> TEMPORARY RAILING FOR HORIZONTAL EDGES .....	159
<b>EDGE TEMP 4</b> TEMPORARY UNIVERSAL RAILING WITH STEM .....	159

## LADDER HOOKS

---

<b>HANG TEMP</b> MOBILE LADDER HOOK .....	160
<b>HANG ROOF</b> LADDER HOOK FOR PITCHED ROOFS .....	160
<b>HANG WALL</b> LADDER HOOK FOR WALL .....	161
<b>HANG PLAIN</b> LADDER HOOK FOR FLAT SURFACES .....	161

## TEMPORARY FALL PROTECTION NETS

---

<b>HORIZONTAL NET</b> HORIZONTAL POLYPROPYLENE FALL PROTECTION SAFETY NET .....	162
<b>VERTICAL NET</b> VERTICAL POLYPROPYLENE FALL PROTECTION SAFETY NET .....	164
<b>FRAME NET</b> FALL PROTECTION SAFETY NET WITH FRAME .....	165

# COLLECTIVE PROTECTIVE EQUIPMENT AND ACCESSES

## COLLECTIVE PROTECTIVE EQUIPMENT

Collective Protective Equipment (CPE) are aimed at safeguarding people's health and safety. The use of CPE should be seen as a priority with respect to the the use of Personal Protective Equipment (PPE).

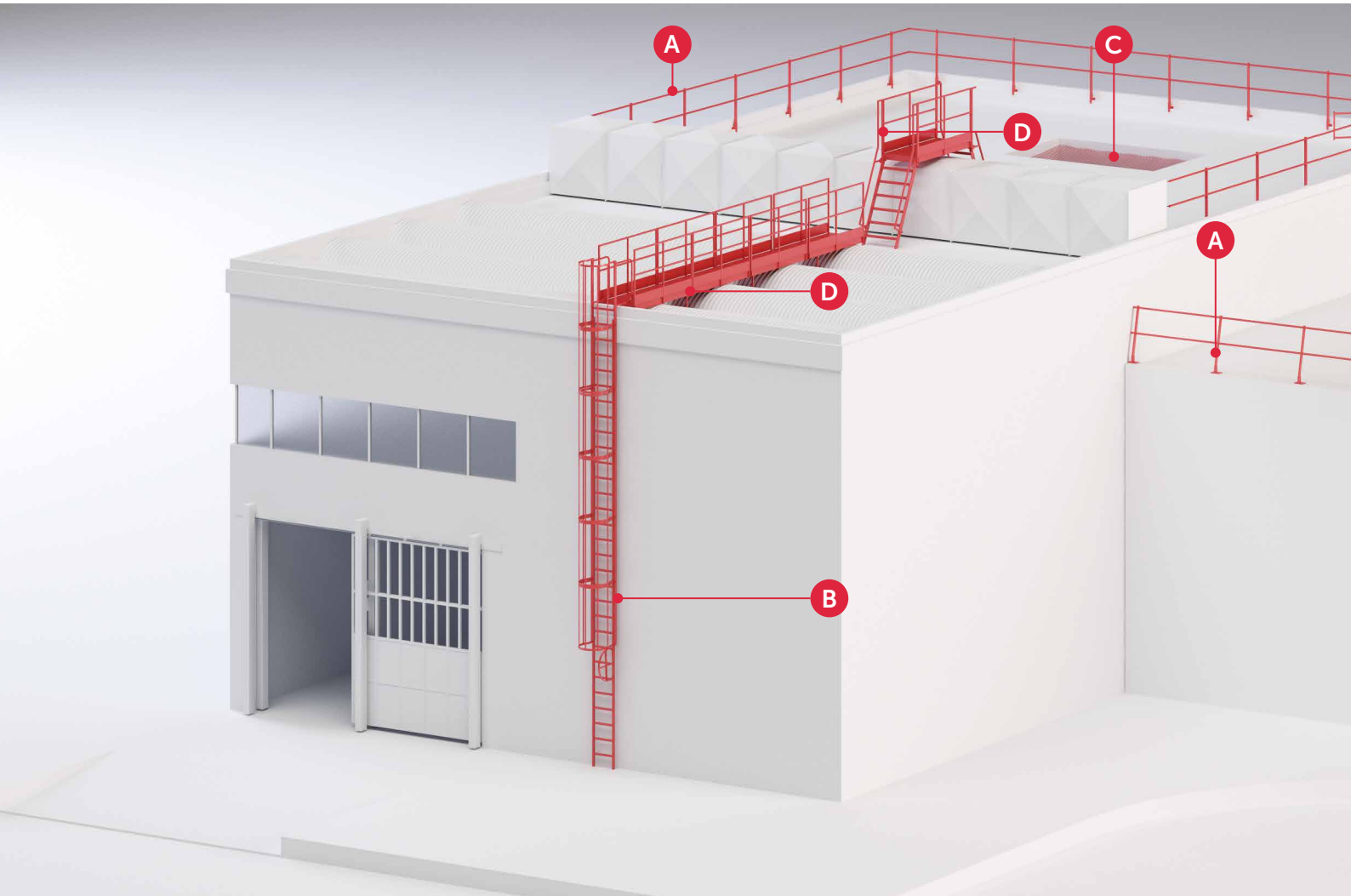

### **A** PERMANENT RAILING BARRIERS

Permanent protections protect everyone who climbs on roofs from falls. Workers can move freely without PPE when permanent railings are installed. Compliant with standards EN 14122-3.

### **B** FIXED LADDERS

Ladders for safe access to workplaces at height, with or without cage. Versions without a cage can be combined with the VERTIGRIP vertical lifeline system. All ladders are designed according to Legislative Decree 09/04/2008 no. 81 "Testo Unico" and according to EN 14122-4.

### **C** PERMANENT FALL PROTECTION NET

They protect workers from falling inside the building and are permanently mounted.

## ACCESSES

The term "access" identifies a point, that can be reached via a path allowing the safe transfer of one or more operators, materials and tools to the roofing.

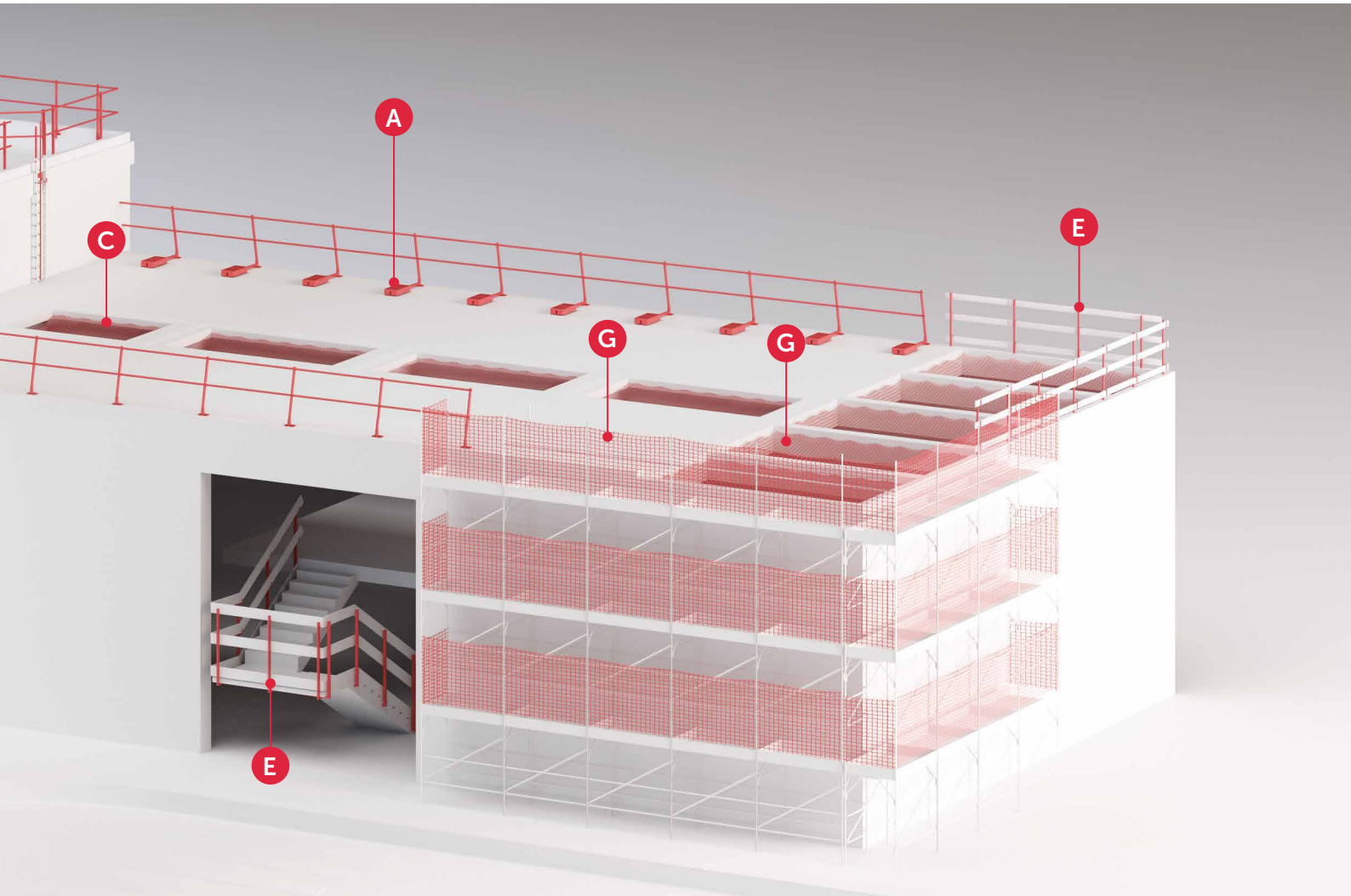

**D** WALKWAYS AND OVERPASSES

Walkways that allow to create safe routes on fragile roofs and overcome obstacles. These systems comply with EN 14122-2 and EN 14122-3.

**E** TEMPORARY RAILING BARRIERS

Temporary protection against falls from height during installation and maintenance work. Compliant with standard 13374.

**F** LADDER HOOKS

Ladder hooks are designed to prevent portable ladders from sliding sideways and frontally. Ideal for use where there is no internal access to the roof.

**G** TEMPORARY FALL PROTECTION NETS

Fall protection nets for maintenance workers and technicians. They offer freedom of movement and absorb the impact in the event of a fall.

# GUARD

## PERMANENT ALUMINIUM RAILINGS

### SIMPLE

Fast and easy to assemble, installation only takes a few steps.

### COMBINABLE

Modular system, can meet any design requirement thanks to the wide range of available accessories.

### AESTHETICS AND DURABILITY

The aluminium alloy guarantees an aesthetic system and good corrosion resistance in the long term.

EN  
14122-3:  
2016

EN  
13374+A1:  
2018

NTC  
2018

NF  
E85-015:  
2019



▼ *Installation of permanent railings for securing an industrial roof.*



VIDEO



MANUALS



## TYPES OF FASTENING



GUARD H  
HORIZONTAL  
FASTENING



GUARD V/GUARD VD  
VERTICAL SPACED



GUARD W  
SELF-SUPPORTING



Z GUARD  
Z SHAPED BASE  
(FASTENING)



GUARD M ON METAL  
SHEET/METAL  
PANEL

## TYPES OF UPRIGHTS



STRAIGHT  
UPRIGHT - S



INCLINED  
UPRIGHT - I



FOLDING  
UPRIGHT - F\*



Material: EN AW-6063 aluminium,  
anodised or powder-coated on request (RAL colours)



\* On demand.

## SPACING BY TYPE OF FASTENER

TYPE	upright/frets	SPACING FOR UPRIGHT $H_{max} = 118 \text{ cm}$			
		EN 14122-3:2016 [cm]	EN 13374+A1:2018 [cm]	NTC 2018 [cm]	NF E85-015:2019 [cm]
GUARD H	straight	150	-	133	150
	inclined	150	-	100	150
GUARD V - VD	straight	150	-	133	150
	inclined	150	-	100	150
GUARD W	straight	150	250	75	150
	inclined	150	250	75	150
GUARD Z	straight	150	-	133	150
	inclined	150	-	100	150
GUARD M	frets spacing 250 mm	150	-	-	150
	frets spacing 333 mm	166	-	-	166

RAILING WITHOUT TOE BOARD



with curb greater than 150 mm

RAILING WITH TOE BOARD



without curb or less than 150 mm

# GUARD H

## HORIZONTAL FASTENING RAILING

EN  
14122-3:  
2016

NTC  
2018

NF  
E85-015:  
2019

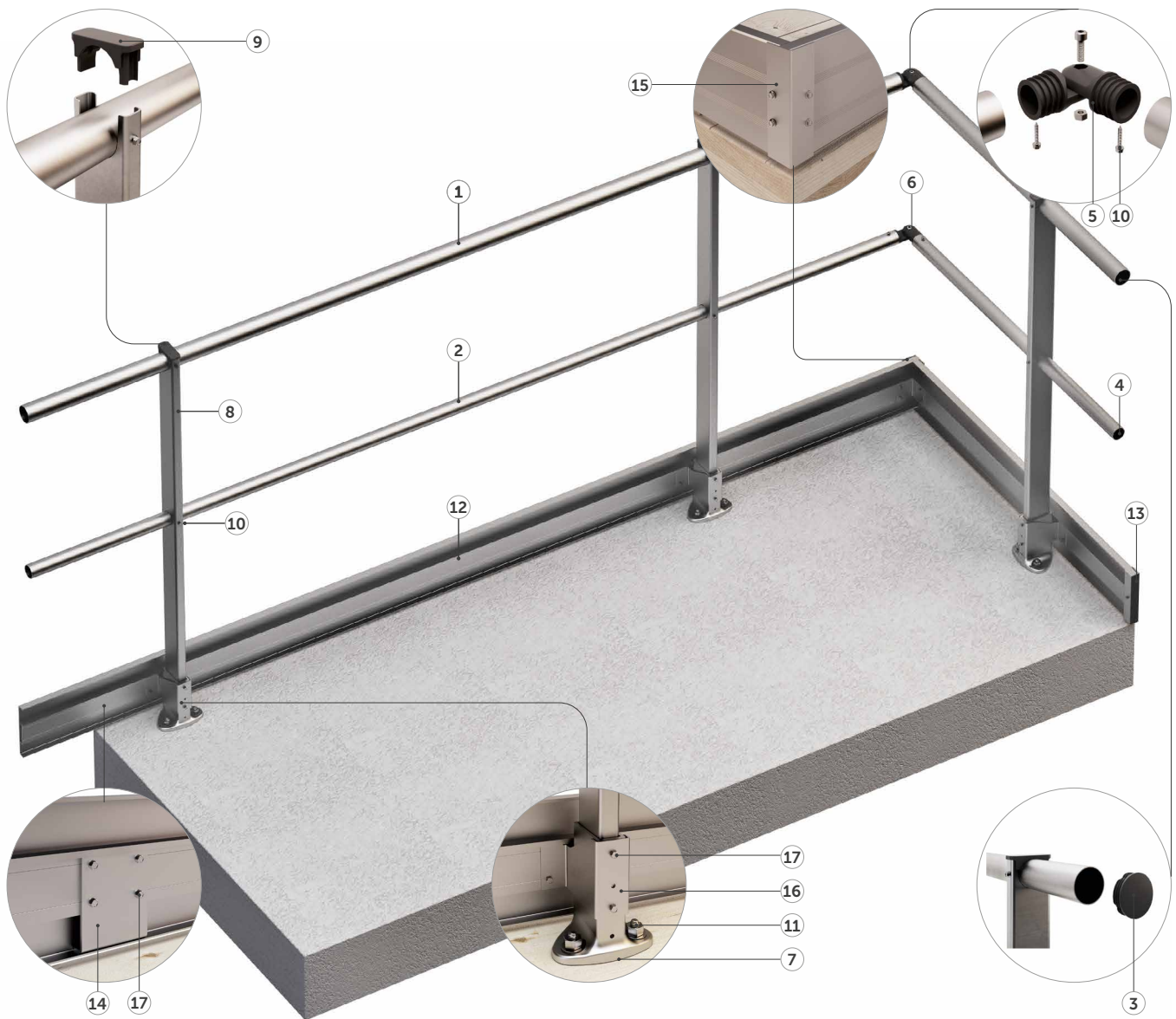

CODE	description
1 RBGBAR45	Ø45 mm handrail with flush-mounted ring nuts L = 3000 mm
2 RBGBAR35	Ø35 mm intermediate rail with flush-mounted ring nuts L = 3000 mm
3 RBGCAP45	cap for handrail Ø45 mm
4 RBGCAP35	cap for intermediate rail Ø35 mm
5 RBGCOR45	angle bracket for handrail Ø45 mm
6 RBGCOR35	angle bracket for intermediate rail Ø35 mm
5-6 RBGCORAL	aluminium angle bracket for handrail and intermediate rail (alternative to RBGCOR45/ RBGCOR35)
7 RBGBASEH	bottom plate horizontal fastening painted grey GUARD H with grub screws included
RBGSUP110	straight upright H = 1105 mm groove Ø45 mm
RBGSUP118	straight upright H = 1182 mm groove Ø45 mm
8 RBGSUP1151	inclined upright H = 1157 mm groove Ø45 mm
RBGBASEHKIT	waterproofing kit for GUARD H base

CODE	description
9 RBGCAP	upright cap 68 x 28 mm groove Ø45 mm
10 RBGSCR4825	stainless steel self-drilling screw 4,8 x 25 mm
11 RBGSCR810	grub screw M8 x 10 mm (spare part)
12 RBGTB	toe board 3000 x 150 x 19 mm
13 RBGTBCAP	cap for toe board H = 150 mm
14 RBGTBJUN	straight connector toe board H = 150 mm
15 RBGTBCOR	angle bracket for toe board H = 150 mm
16 RBGTBH	support for toe board H = 150 mm
17 RBGSCR4816	stainless steel self-drilling screw 4,8 x 16 mm

For wall fastening:

RBGWALL45	end element for handrail Ø45 mm
RBGWALL35	end element for round intermediate rail Ø35 mm
RBGWALLAL	aluminium end element for handrail and intermediate rail



# GUARD V/GUARD VD

## RAILING VERTICAL AND VERTICAL SPACED FASTENING

EN  
14122-3:  
2016

NTC  
2018

NF  
E85-015:  
2019

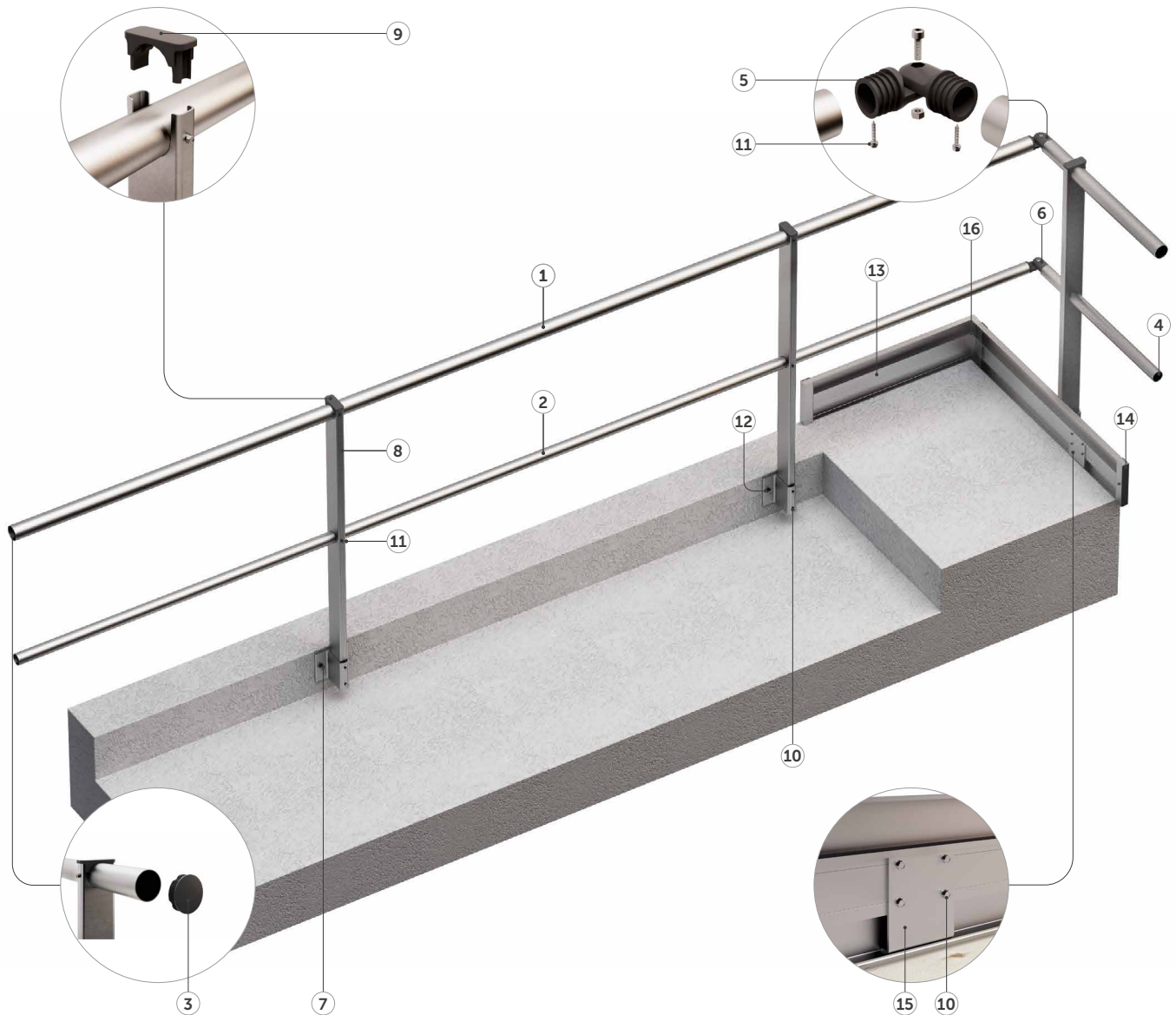

CODE	description
1 RBGBAR45	Ø45 mm handrail with flush-mounted ring nuts L = 3000 mm
2 RBGBAR35	Ø35 intermediate rail with flush-mounted ring nuts L = 3000 mm
3 RBGCAP45	cap for handrail Ø45 mm
4 RBGCAP35	cap for intermediate rail Ø35 mm
5 RBGCOR45	angle bracket for handrail Ø45 mm
6 RBGCOR35	angle bracket for intermediate rail Ø35 mm
5-6 RBGCORAL	aluminium angle bracket for handrail and intermediate rail (alternative to RBGCOR45/ RBGCOR35)
7 RBGBASEV	bottom plate for wall fastening GUARD V
7 RBGBASEVD	bottom plate for fastening on projecting wall GUARD VD
8 RBGSUP118	straight upright H = 1182 mm groove Ø45 mm
8 RBGSUP130	straight upright H = 1300 mm groove Ø45 mm
9 RBGCAP	upright cap 68 x 28 mm groove Ø45 mm

CODE	description
10 RBGSCR4816	stainless steel self-drilling screw 4,8 x 16 mm
11 RBGSCR4825	stainless steel self-drilling screw 4,8 x 25 mm
12 RBGSCR4832	stainless steel self-drilling screw 4,8 x 32 mm
13 RBGTB	toe board 3000 x 150 x 19 mm
14 RBGTBCAP	cap for toe board H = 150 mm
15 RBGTBJUN	straight connector toe board H = 150
16 RBGTBCOR	angle bracket for toe board H = 150 mm
RBGSUP115I	inclined upright H = 1157 mm groove Ø45 mm
RBGDIST	spacer element GUARD V-VD + 35 mm

For wall fastening:

RBGWALL45	end element for handrail Ø45 mm
RBGWALL35	end element for round intermediate rail Ø35 mm
RBGWALLAL	aluminium end element for handrail and intermediate rail

# GUARD W

## SELF-SUPPORTING RAILING

EN  
14122-3:  
2016

EN  
13374+A1:  
2018

NTC  
2018

NF  
E85-015:  
2019

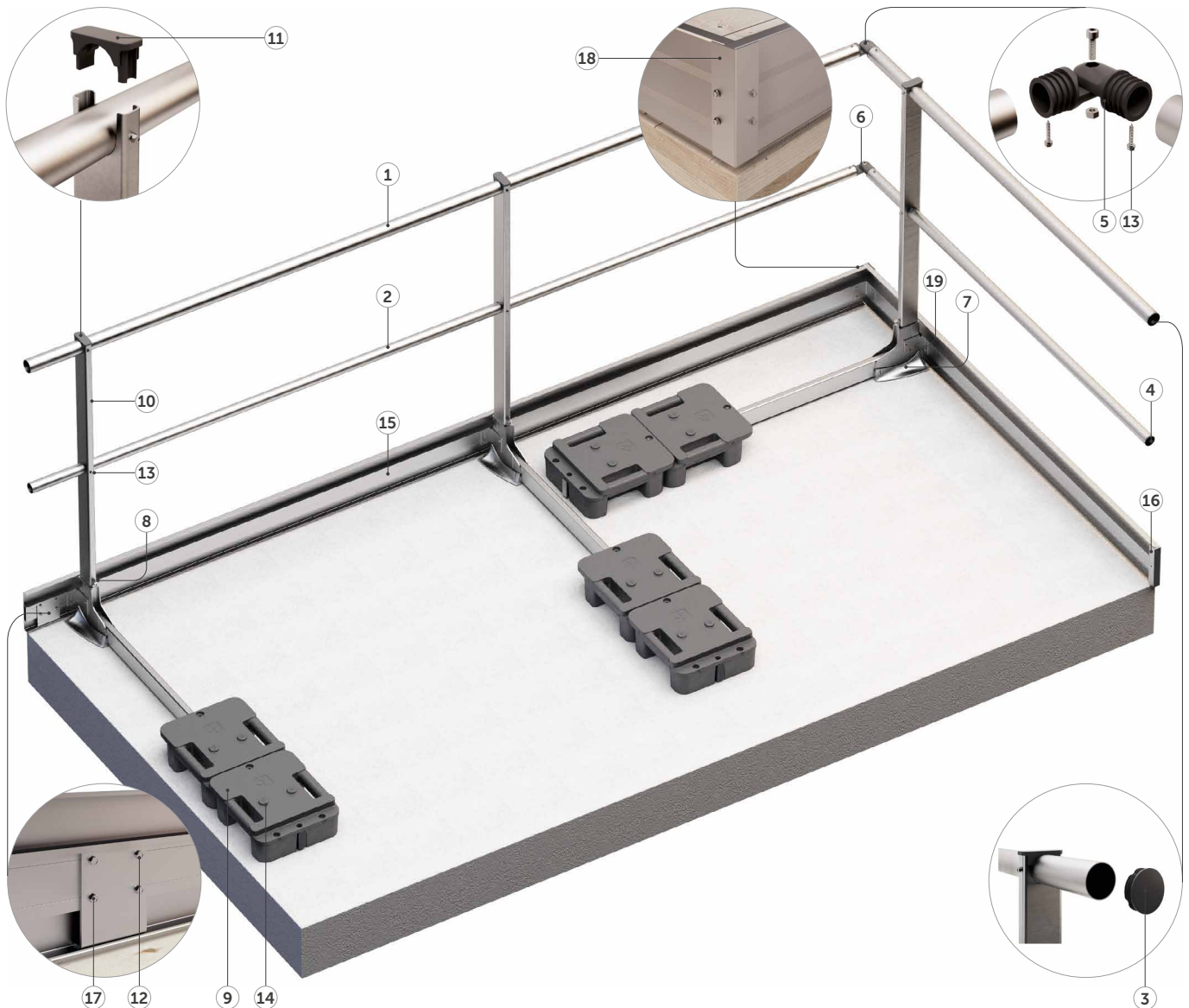

CODE	description
1 RBGBAR45	Ø45 mm handrail with flush-mounted ring nuts L = 3000 mm
2 RBGBAR35	Ø35 intermediate rail with flush-mounted ring nuts L = 3000 mm
3 RBGCAP45	cap for handrail Ø45 mm
4 RBGCAP35	cap for intermediate rail Ø35 mm
5 RBGCOR45	angle bracket for handrail Ø45 mm
6 RBGCOR35	angle bracket for intermediate rail Ø35 mm
5-6 RBGCORAL	aluminium angle bracket for handrail and intermediate rail (alternative to RBGCOR45/ RBGCOR35)
7 RBGBASEW	base for self-supporting GUARD W straight with support leg
8 RBGBASEWE	locking wedge for GUARD W
RBGBASEWI	base for self-supporting GUARD W inclined with support leg
9 RBGWEIGHT	plastic counterweight 12,5 kg for GUARD W
RBGSUP110	straight upright H = 1105 mm groove Ø45 mm
10 RBGSUP118	straight upright H = 1182 mm groove Ø45 mm

CODE	description
11 RBGCAP	upright cap 68 x 28 mm groove Ø45 mm
12 RBGSCR4816	stainless steel self-drilling screw 4,8 x 16 mm
13 RBGSCR4825	stainless steel self-drilling screw 4,8 x 25 mm
14 RBGSCR4850	stainless steel self-drilling screw 4,8 x 50 mm
15 RBGTB	toe board 3000 x 150 x 19 mm
16 RBGTBCAP	cap for toe board H = 150 mm
17 RBGTBJUN	straight connector toe board H = 150 mm
18 RBGTBCOR	angle bracket for toe board H = 150 mm
19 RBGTBH	support for toe board H = 150 mm

For wall fastening:

RBGWALL45	end element for handrail Ø45 mm
RBGWALL35	end element for round intermediate rail Ø35 mm
RBGWALLAL	aluminium end element for handrail and intermediate rail

# GUARD Z

## A Z FASTENING RAILING

EN  
14122-3:  
2016

NTC  
2018

NF  
E85-015:  
2019

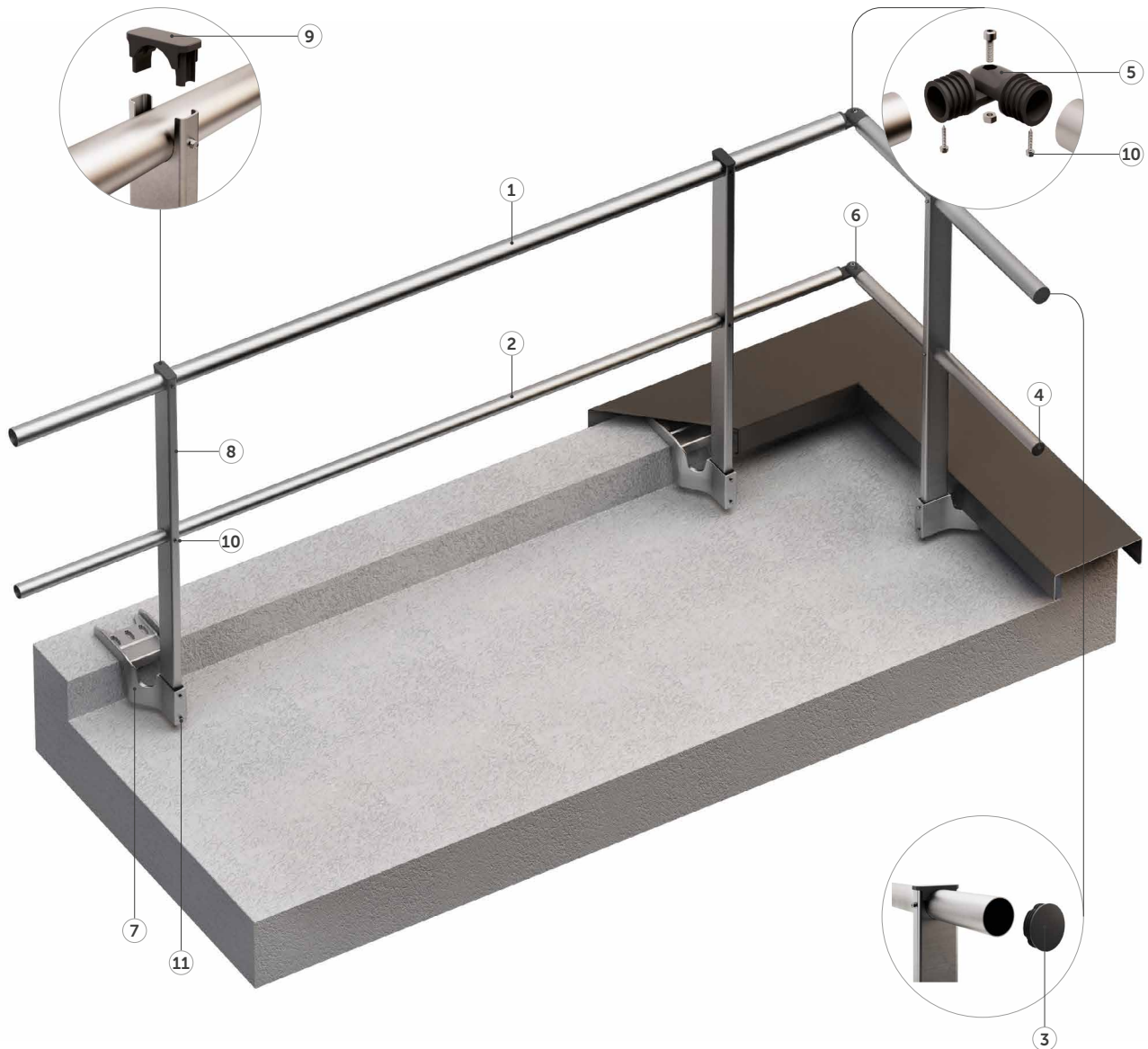

CODE	description
1 RBGBAR45	Ø45 mm handrail with flush-mounted ring nuts L = 3000 mm
2 RBGBAR35	Ø35 intermediate rail with flush-mounted ring nuts L = 3000 mm
3 RBGCAP45	cap for handrail Ø45 mm
4 RBGCAP35	cap for intermediate rail Ø35 mm
5 RBGCOR45	angle bracket for handrail Ø45 mm
6 RBGCOR35	angle bracket for intermediate rail Ø35 mm
5-6 RBGCORAL	aluminium angle bracket for handrail and intermediate rail (alternative to RBGCOR45/ RBGCOR35)
7 RBGBASEZ	standard aluminium base Z for perimeter wall without insulation GUARD Z with grub screws included
RBGSUP110	straight upright H = 1105 mm groove Ø45 mm
8 RBGSUP118	straight upright H = 1182 mm groove Ø45 mm
RBGSUP115I	inclined upright H = 1157 mm groove Ø45 mm
9 RBGCAP	upright cap 68 x 28 mm groove Ø45 mm
10 RBGSCR4825	stainless steel self-drilling screw 4,8 x 25 mm

CODE	description
11 RBGSCR810	grub screw M8 x 10 mm (spare part)
For wall fastening:	
RBGWALL45	end element for handrail Ø45 mm
RBGWALL35	end element for round intermediate rail Ø35 mm
RBGWALLAL	aluminium end element for handrail and intermediate rail

# GUARD M

EN  
14122-3:  
2016

NF  
E85-015:  
2019



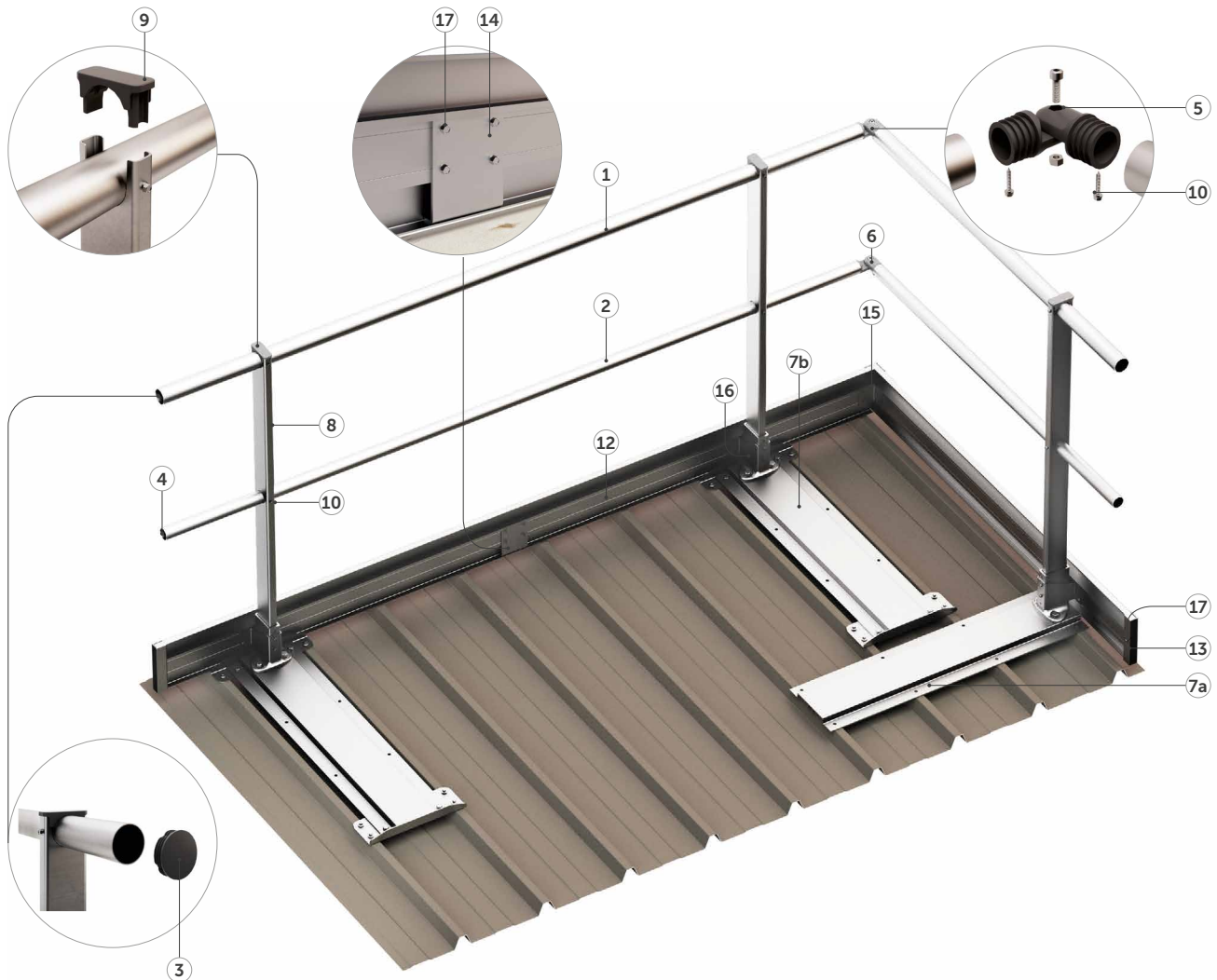

## RAILING FASTENING ON TRAPEZOIDAL METAL ROOF





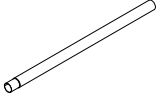
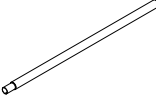
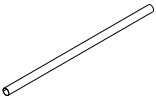
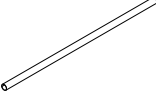

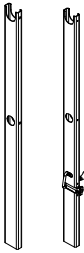
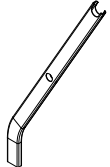
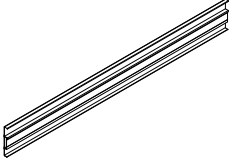
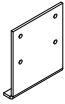
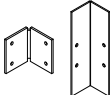
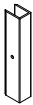

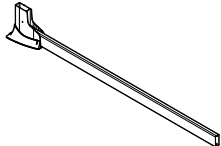
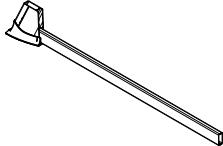
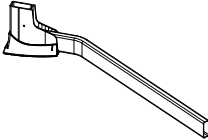
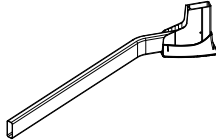
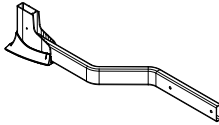
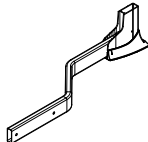

CODE	description
1 RBGBAR45	Ø45 mm handrail with flush-mounted ring nuts L = 3000 mm
2 RBGBAR35	Ø35 intermediate rail with flush-mounted ring nuts L = 3000 mm
3 RBGCAP45	cap for handrail Ø45 mm
4 RBGCAP35	cap for intermediate rail Ø35 mm
5 RBGCOR45	angle bracket for handrail Ø45 mm
6 RBGCOR35	angle bracket for intermediate rail Ø35 mm
5-6 RBGCORAL	aluminium angle bracket for handrail and intermediate rail (alternative to RBGCOR45/RBGCOR35)
RBGBASE250PE	plate for fastening to trapezoidal sheet metal, pitch 250 mm, perpendicular to the frets (excluding screws)
7a RBGBASE333PE	plate for fastening to trapezoidal sheet metal, pitch 333 mm, perpendicular to trapezoidal sheet metal (excluding screws)
RBGBASE250PA	plate for fastening to trapezoidal sheet metal, pitch 250 mm, parallel to trapezoidal sheet metal (excluding screws)
7b RBGBASE333PA	plate for fastening to trapezoidal sheet metal, pitch 333 mm, parallel to trapezoidal sheet metal (excluding screws)

CODE	description
RBGSUP110	straight upright H = 1105 mm groove Ø45 mm
8 RBGSUP118	straight upright H = 1182 mm groove Ø45 mm
RBGSUP115I	inclined upright H = 1157 mm groove Ø45 mm
CODE	description
9 RBGCAP	upright cap 68 x 28 mm groove Ø45 mm
10 RBGSCR4825	stainless steel self-drilling screw 4,8 x 25 mm
11 RBGSCR810	M8 x 10 mm grub screw included in the base
12 RBGTB	toe board 3000 x 150 x 19 mm
13 RBGTBCAP	cap for toe board H = 150 mm
14 RBGTBJUN	straight connector toe board H = 150 mm
15 RBGTBCOR	angle bracket for toe board H = 150 mm
16 RBGTBH	support for toe board H = 150 mm
17 RBGSCR4816	stainless steel self-drilling screw 4,8 x 16 mm
For wall fastening:	
RBGWALL45	end element for handrail Ø45 mm
RBGWALL35	end element for round intermediate rail Ø35 mm
RBGWALLAL	aluminium end element for handrail and intermediate rail

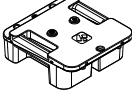

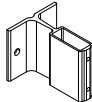







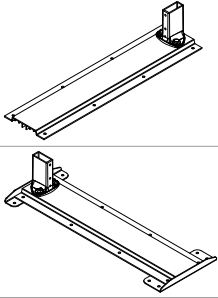





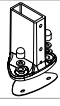

## CODES AND DIMENSIONS

GROUP	CODE	description	pcs	
HANDRAILS AND INTERMEDIATE RAILS	RBGBAR45	Ø45 mm handrail with flush-mounted ring nuts L = 3000 mm	1	
	RBGBAR35	Ø35 intermediate rail with flush-mounted ring nuts L = 3000 mm	1	
	RBGBAR45F	handrail without flush-mounted ring nuts Ø45 mm L = 3000 mm	1	
	RBGBAR35F	handrail without flush-mounted ring nuts Ø35 mm L = 3000 mm	1	
	RBGCAP	upright cap 68 x 28 mm groove Ø45 mm	1	
UPRIGHTS	RBGSUP100	straight upright H = 1028 mm groove Ø45 mm	1	
	RBGSUP110	straight upright H = 1105 mm groove Ø45 mm	1	
	RBGSUP118	straight upright H = 1182 mm groove Ø45 mm	1	
	RBGSUP110F	pull-down upright H = 1105 mm groove Ø45 mm	1	
	RBGSUP100F	pull-down upright H = 1010 mm groove Ø45 mm	1	
	RBGSUP130	straight upright H = 1300 mm groove Ø45 mm	1	
	RBGSUP115I	inclined upright H = 1157 mm groove Ø45 mm	1	
TOE BOARD AND ACCESSORIES	RBGTB	toe board 3000 x 150 x 19 mm	1	
	RBGTBJUN	straight connector of toe board H = 150 mm	1	
	RBGTBCOR	angle bracket for toe board H = 150 mm	1	
	RBGTBCAP	cap for toe board H = 150 mm	1	
	RBGTBW	support for toe board H = 150 mm for GUARD W	1	
	RBGTBH	support for toe board H = 150 mm	1	

## CODES AND DIMENSIONS

GROUP	CODE	description	pcs	
STANDARD BASES	RBGBASEW	base for self-supporting GUARD W straight with support leg	1	
	RBGBASEWI	base for self-supporting GUARD W inclined with support leg	1	
	RBGBASEWFCR	shank curved at right at 25° per angle	1	
	RBGBASEWFCL	shank curved at left at 25° per angle	1	
	RBGBASEWFR	shank with curve at right for folding railing	1	
	RBGBASEWFL	shank with curve at left for folding railing	1	
	RBGBASEWE	locking wedge for GUARD W (spare part)	1	
	RBGWEIGHT	plastic counterweight 12,5 kg for GUARD W	3	
	RBGBASEV	bottom plate for wall fastening GUARD V	1	
	RBGBASEVD	bottom plate for fastening on projecting wall GUARD VD	1	
	RBGDIST	spacer piece GUARD V-VD + 35 mm	1	
	RBGBASEH	bottom plate horizontal fastening painted grey GUARD H	1	
RBGBASEZ	standard aluminium base Z for perimeter wall without insulation GUARD Z	1		

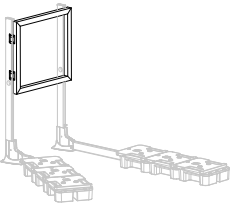
## CODES AND DIMENSIONS

GROUP	CODE	description	pcs	
BASES FOR FASTENING ON TRAPEZOIDAL METAL ROOF	RBGBASE250PA	plate for fastening to trapezoidal sheet metal, pitch 250 mm, parallel to trapezoidal sheet metal (excluding screws)	1	
	RBGBASE333PA	plate for fastening to trapezoidal sheet metal, pitch 333 mm, parallel to trapezoidal sheet metal (excluding screws)	1	
	RBGBASE250PE	plate for fastening to trapezoidal sheet metal, pitch 250 mm, perpendicular to the frets (excluding screws)	1	
	RBGBASE333PE	plate for fastening to trapezoidal sheet metal, pitch 333 mm, perpendicular to trapezoidal sheet metal (excluding screws)	1	
ACCESSORIES	RBGCAP45	cap for handrail Ø45 mm	1	
	RBGCAP35	cap for intermediate rail Ø35 mm	1	
	RBGCOR45	angle bracket for handrail Ø45 mm	1	
	RBGCOR35	angle bracket for intermediate rail Ø35 mm	1	
	RBGWALL45	end element for handrail Ø45 mm	1	
	RBGWALL35	end element for intermediate rail Ø35 mm	1	
	RBGCORAL	aluminium angle bracket for handrail	1	
	RBGWALLAL	aluminium end element for handrail	1	
	RBGBASEHKIT	waterproofing kit for base GUARD H	1	
	RBGWEDGE	plastic wedge for shimming	1	
FASTENING SCREWS	RBGSCR4816	stainless steel self-drilling screw 4,8 x 16 mm	25	
	RBGSCR4825	stainless steel self-drilling screw 4,8 x 25 mm	25	
	RBGSCR4832	stainless steel self-drilling screw 4,8 x 32 mm	25	
	RBGSCR4850	stainless steel self-drilling screw 4,8 x 50 mm	25	
	RBGSCR627	self-drilling screw for stainless steel sheet 6 x 27 mm	25	
	RBGSCR810	grub screw M8 x 10 (spare part)	10	
	RBGSCRWAS	sealing washer	25	
SAFETY GATES KIT	RBGGATE600	safety door 500 mm height with hinges assembled L = 600 mm	1	
	RBGGATE1100	safety door 500 mm height with hinges width L = 1100 mm	1	
MANUALS	RBGUARDHMAN	manual for GUARD H	1	
	RBGUARDVMAN	manual for GUARD V	1	
	RBGUARDMMAN	manual for GUARD M	1	
	RBGUARDZMAN	manual for GUARD Z	1	
	RBGUARDWMAN	manual for GUARD W	1	

# LADSTEP

## CAGED LADDERS

D.Lgs.  
81/2008

EN 14122-4

### DURABLE

Made of aluminium alloy, they offer high mechanical resistance and resist corrosion and environmental conditions.

### RELIABLE

Guarantee the utmost safety for the user and give the installer the serenity that comes with a reliable product that is easy to assemble.

### COMBINABLE

Thanks to the wide range of available components, the modular system can meet any design requirement.

▼ *Aluminium ladder with landing platforms for access to industrial roof.*



VIDEO



MANUALS





## ■ CAGED LADDERS COMPONENTS

### MAIN COMPONENTS

1

2

3

4

5

6

7

8

### ACCESSORIES

1a

2a

3a

4a

5a

6a



n.	CODE
1	LADMODCAP / LADBARCAP
2	LADEXT130 / LADBAR130
3	LADRINGIT / LADRINGEU
4	LADMOD90 / LADMOD120 / LADMOD150 / LADMOD180 / LADMOD210 / LADMOD240
5	LADJUN
6	LADBRA150 / LADBRA200 / LADBRA250 / LADBRA300 / LADBRA350 / LADBRA400 / LADBRA450 / LADBRA500 / LADBRA550 / LADBRA600
7	LADBAR90 / LADBAR120 / LADBAR150 / LADBAR180 / LADBAR210 / LADBAR240
8	MMSA26319 / MMSA26325

n.	CODE
1a	LADHANDS
2a	LADEXTMOB130
3a	LADBOARIT / LADBOAREU / LADREST
4a	LADHOOK
5a	LADTRAPIT / LADTRAPEU
6a	LADFEHIN / LADFEREG



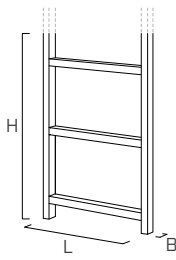
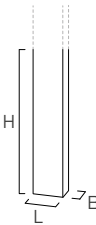

# LADSTEP | basic components

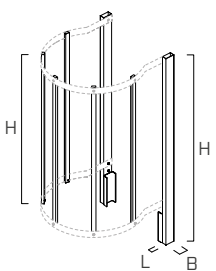
## CODES OF BASIC COMPONENTS FOR FIXED CAGED/CAGELESS LADDERS

GROUP	CODE	description	B [mm]	L [mm]	H [mm]	
LADDER MODULES	LADMOD90	ladder module 0,90 m - 3 steps	60	500	900	
	LADMOD120	ladder module 1,20 m - 4 steps	60	500	1200	
	LADMOD150	ladder module 1,50 m - 5 steps	60	500	1500	
	LADMOD180	ladder module 1,80 m - 6 steps	60	500	1800	
	LADMOD210	ladder module 2,10 m - 7 steps	60	500	2100	
	LADMOD240	ladder module 2,40 m - 8 steps	60	500	2400	
CAGE BARS	LADBAR90	kit of 5 cage bars 0,90 m	15	25	900	
	LADBAR120	kit of 5 cage bars 1,20 m	15	25	1200	
	LADBAR150	kit of 5 cage bars 1,50 m	15	25	1500	
	LADBAR180	kit of 5 cage bars 1,80 m	15	25	1800	
	LADBAR210	kit of 5 cage bars 2,10 m	15	25	2100	
	LADBAR240	kit of 5 cage bars 2,40 m	15	25	2400	
RINGS	LADRINGIT	cage ring Leg. Decree 81/2008	662	600	40	
	LADRINGEU	cage ring EN 14122	762	700	40	
FINAL PROTECTION	LADEXT130	extension 1.30 m	60	30	1300	
	LADBAR130	kit of 5 cage bars 1,04 m	15	25	1040	

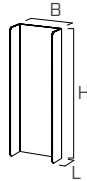
Add two rings: LADRINGIT or LADRINGEU to complete the final protection.

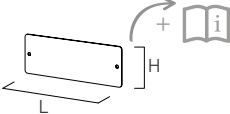
GROUP	CODE	description	B [mm]	L [mm]	H [mm]	
BRACKETS	LADBRA150	bracket for wall spacing 150 mm	210	512	60	
	LADBRA200	bracket for wall spacing 200 mm	260	512	60	
	LADBRA250	bracket for wall spacing 250 mm	310	512	60	
	LADBRA300	bracket for wall spacing 300 mm	360	512	60	
	LADBRA350	bracket for wall spacing 350 mm	410	512	60	
	LADBRA400 + LADSTRAP400	bracket for wall spacing 400 mm + clearance with screws included	460	512	60	
	LADBRA450 + LADSTRAP450	bracket for wall spacing 450 mm + clearance with screws included	510	512	60	
	LADBRA500 + LADSTRAP500	bracket for wall spacing 500 mm + clearance with screws included	560	512	60	
	LADBRA550 + LADSTRAP550	bracket for wall spacing 550 mm + clearance with screws included	610	512	60	
LADBRA600 + LADSTRAP600	bracket for wall spacing 600 mm + clearance with screws included	660	512	60		
JOINTS	LADJUN	ladder joint	55	25	150	
CAPS	LADMODCAP	cap for upper upright closure	60	30	20	
	LADBARCAP	cap for bar closure	15	25	15	
LABEL	LADPLATEIT	label Leg. Decree 81/2008 + IT manual	-	110	50	
	LADPLATEEU	label EN 14122-4 + EN manual	-	110	50	
STANDARD FASTENING	MMSA26319	stainless steel screw DIN 7504 A2 K 6,3 x 19 mm				
BRACKETS FASTENING	MMSA26325	stainless steel screw DIN 7504 A2 K 6,3 x 25 mm				

Other codes/components available on request.

# LADSTEP | accessory components

## CODES OF ACCESSORY COMPONENTS FOR FIXED CAGED/CAGELESS LADDERS\*

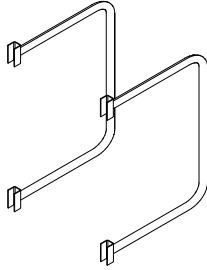
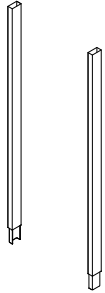
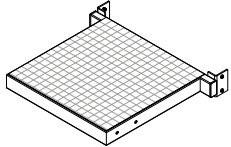
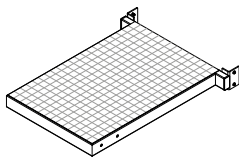
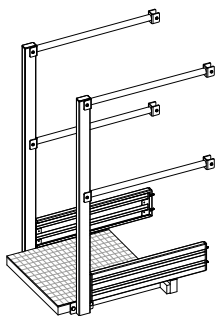
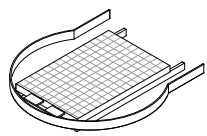
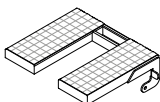
GROUP	CODE	description	
HANDLES	LADHANDS	kit of 2 landing handles 450 mm	
INTERLOCKING EXTENSION	LADEXTMOB130	interlocking extension 1.30 m for easy access to the roof	
LANDING PLATFORMS	LADLAND500	500 x 500 mm final landing platform, non-slip	
	LADLAND750	500 x 750 mm final landing platform, non-slip	
PROTECTION KIT	LADPROT750	750 mm platform protection kit complete with 4 handrails, 2 aluminium toeboards	
FOLDING PLATFORMS	LADBOARIT	folding or resting platform for ladder subdivision (with lifting and lowering system) Leg. Decree 81/2008 Ø600 mm	
	LADBOAREU	folding or resting platform for ladder subdivision (with lifting and lowering system) EN 14122-4 Ø700 mm	
	LADREST	folding resting platform for ladder with lifeline	

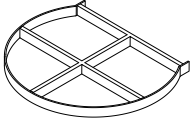
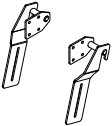
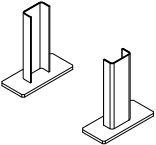
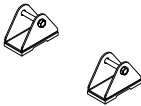
GROUP	CODE	description	
SAFETY CLOSURES	LADTRAPIT	safety closure prepared for padlock (not included) Leg. Decree 81/2008 Ø600 mm	
	LADTRAPEU	safety closure prepared for padlock (not included) EN 14122-4 Ø700 mm	
HOOKS FOR SEPARATE LADDER	LADHOOK	fastening hooks for separate ladder	
FEET	LADFEREG	kit of 2 adjustable support feet with holes for fastening to the ground	
	LADFEHIN	kit of 2 hinged support feet	

Screws, joints, caps always included in the single codes.

## LADDER COMPOSITION INDICATIONS

- Applicable regulations (Leg. Decree 81/2008 - EN 14122-4 - local regulations) must be defined by the designer of the work
- Choice of components according to the regulations applied
- First ladder module with length of 2,4 m
- Cage start at 2,4 m
- First bracket at 0,5 m
- Subsequent brackets installed every 2,0 m

Other components are available on request.  
For the composition, use the handbook or the component spreadsheet, both available on our website: [www.rothoblaas.com](http://www.rothoblaas.com).

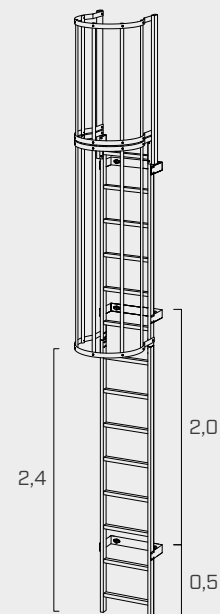

# SAFENET

## CUSTOMIZABLE HORIZONTAL FALL PROTECTION NET

GS BAU  
18:2015

ETA-  
13/0650

ÖNORM B  
3417:2016-5

### COMPLETE

Complete system with A4 stainless steel mesh, pre-assembled perimeter rope, brackets and fasteners included for all types of substructure.

### SIMPLE

Quick and easy assembly with the aid of corner and straight fastening systems.  
Anti-intrusion plate included.

### VERSATILE

Possibility of application to structures of various materials (timber, steel, concrete).



▼ Installation of permanent fall protection safety net in A4 stainless steel for securing a skylight on a flat roof.

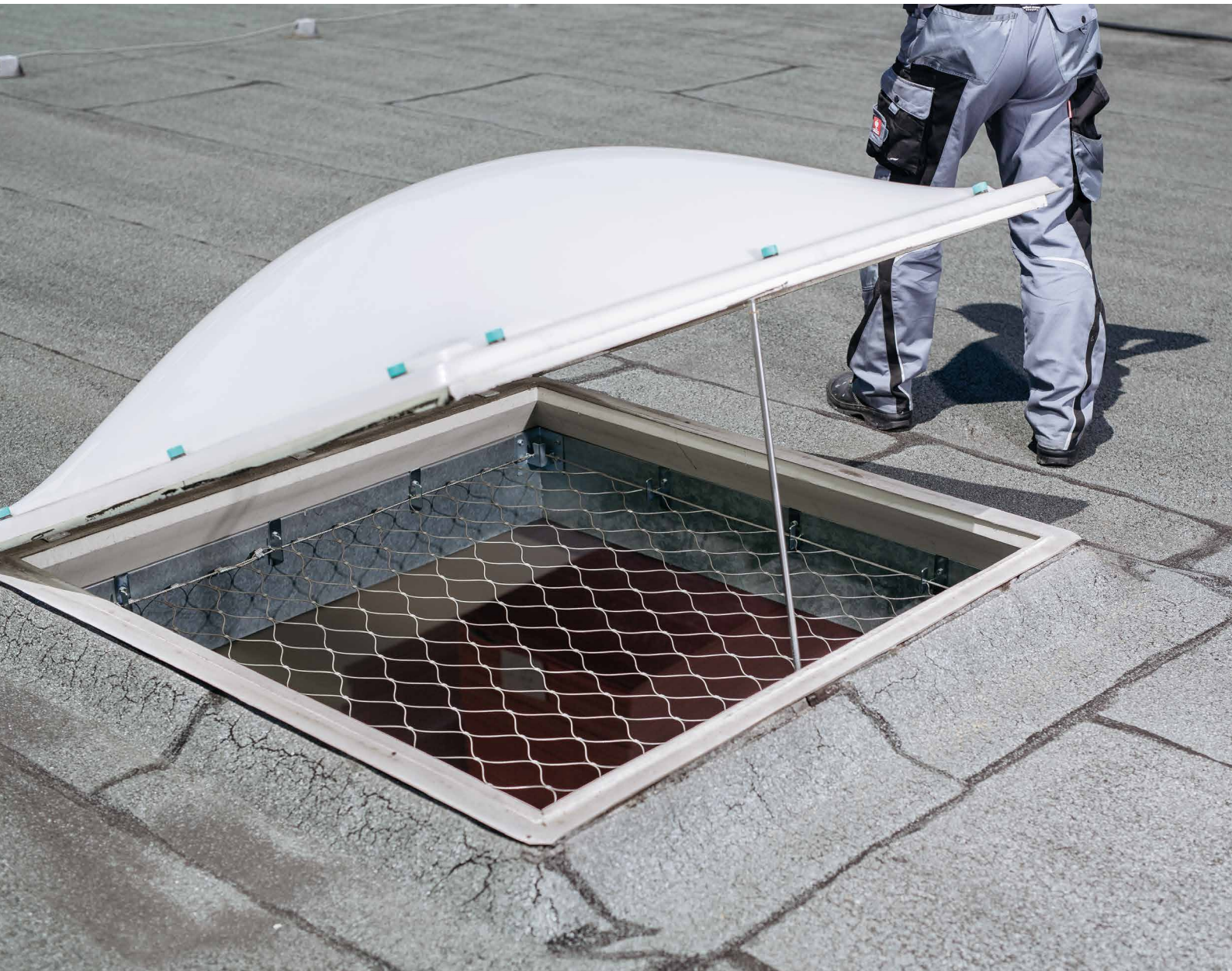

## ■ FIELDS OF APPLICATION

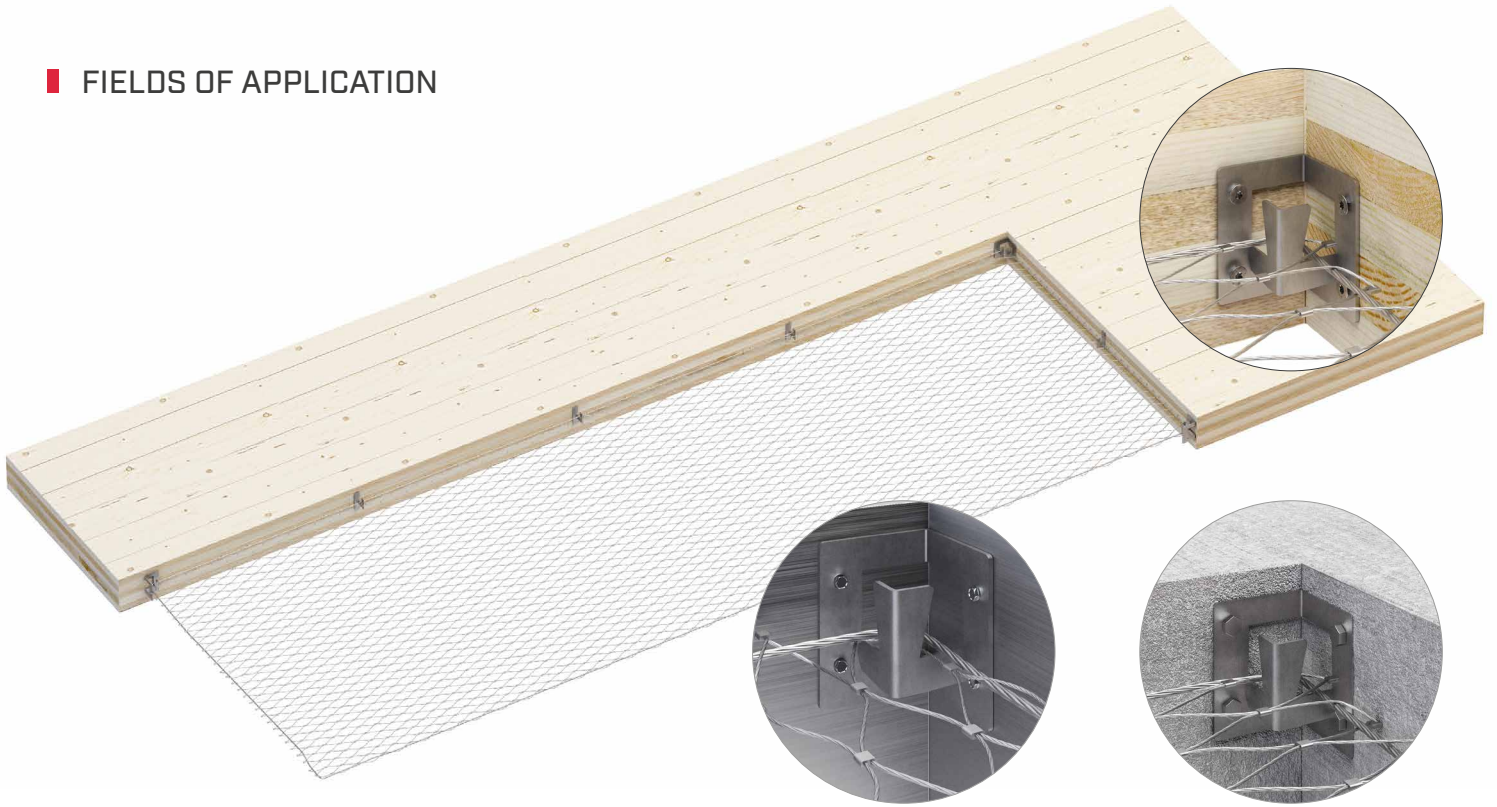

## ■ CODES AND DIMENSIONS

A4 stainless steel mesh with fasteners for various substructures included.

RANGE CODE	description		net surface (from A to B m <sup>2</sup> )
SN01	stainless steel mesh A4	0 - 1 m <sup>2</sup>	from 0,00 to 1.00 m <sup>2</sup>
SN02	stainless steel mesh A4	1 - 2 m <sup>2</sup>	from 1 to 2 m <sup>2</sup>
SN03	stainless steel mesh A4	2 - 3 m <sup>2</sup>	from 2 to 3 m <sup>2</sup>
SN04	stainless steel mesh A4	3 - 4 m <sup>2</sup>	from 3 to 4 m <sup>2</sup>
SN05	stainless steel mesh A4	4 - 6 m <sup>2</sup>	from 4 to 6 m <sup>2</sup>
SN06	stainless steel mesh A4	6 - 10 m <sup>2</sup>	from 6 to 10 m <sup>2</sup>
SN07	stainless steel mesh A4	10 - 15 m <sup>2</sup>	from 10 to 15 m <sup>2</sup>
SN08	stainless steel mesh A4	surface over 15 m <sup>2</sup>	from 15 to M m <sup>2</sup>

## ■ MATERIAL ORDERING SCHEME

Example: skylight with steel structure 0,8 m x 1,2 m = 0,96 m<sup>2</sup>.

SN01	+ M	+ 0080	+ 0120
RANGE CODE surface	fastening on: (W) wood (C) concrete (M) metal	L [m] length	B [m] width

Code created: SN01M00800120.

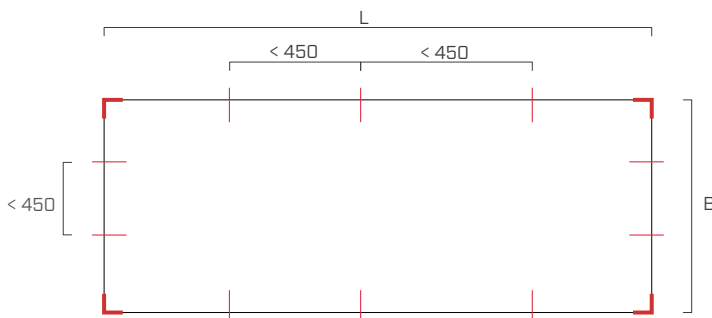

Maximum distances to position the fastening brackets

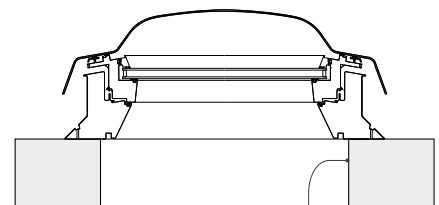

Application of the support element

# ROLLNET

## HORIZONTAL FIXED FALL PROTECTION NET



### ADJUSTABLE

Available in various sizes, to meet all needs of the construction site.

### TRANSPORTATION

Supplied in convenient rolls that facilitate transport and installation.

### EXISTING STRUCTURES

It can be installed on finished buildings without having to disassemble skylights.



▼ *Installation of permanent fall protection safety net for securing a skylight on a roof.*





## ■ FIELDS OF APPLICATION

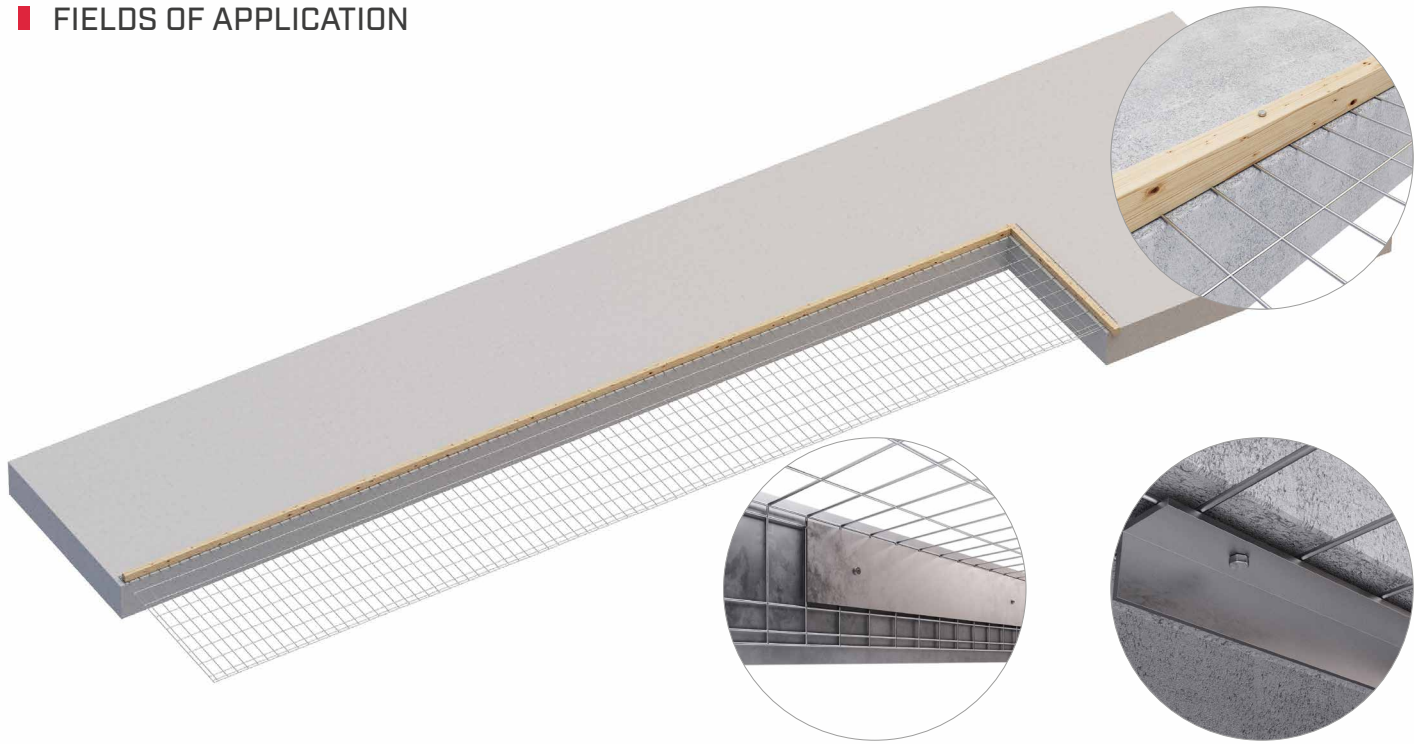

## ■ CODES AND DIMENSIONS

CODE	description	B [mm]	L [m]	pcs
RONET1020	zinc-plated steel	1020	25	1
RONET1220	zinc-plated steel	1220	25	1
RONET1520	zinc-plated steel	1520	25	1
RONET1830	zinc-plated steel	1830	25	1
RONET2030	zinc-plated steel	2030	25	1
RONET2230	zinc-plated steel	2230	25	1
RONET2530	zinc-plated steel	2530	25	1

## ■ INSTALLATION

Wood batten 30 x 40 mm / steel angle bracket 30 x 30 x 3 mm / steel profile 30 x 3 mm

model	B [mm]	clear width space [mm]	fastening spacing [mm]
A-C	1020	0 - 770	1000
	1220	730 - 970	900
	1520	930 - 1270	700
	1830	1230 - 1580	600
	2030	1530 - 1780	500
	2230	1730 - 1980	400
	2530	1930 - 2280	300
B	1020	0 - 840	1000
	1220	820 - 1040	900
	1520	1020 - 1340	700
	1830	1320 - 1650	600
	2030	1630 - 1850	500
	2530	2030 - 2350	300

MODEL A



MODEL B

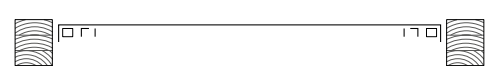

MODEL C



## COMPLEMENTARY PRODUCTS

CODE	description	d <sub>1</sub> [mm]	CODE	description	d <sub>1</sub> [mm]	L [m]	B [mm]	s [mm]
HBS	screw for timber	6	SBS6360	self-drilling timber-metal screw	6,3	60	-	-
SKR	screw anchor for concrete	7,5	SBS6370		6,3	70	-	-
			SBS6385		6,3	85	-	-
			LBB4030	perforated strap	-	50	40	3

# WALKWAYS

## WALKSAFE

D.LGS.81/08

UNIEN  
14122-2

### WALKWAYS

#### RELIABLE

The non-slip, anti-oil, anti-heel and ice resistant coating ensures safe footing.

#### STANDARD MODULES

Available in 1,50 and 3,0 m long modules, from 60 to 80 cm wide. Additional sizes available upon request.

#### MODULAR

Available with or without railing and toe boards, or single-sided. Possibility to be fixed directly or with supports of various heights.

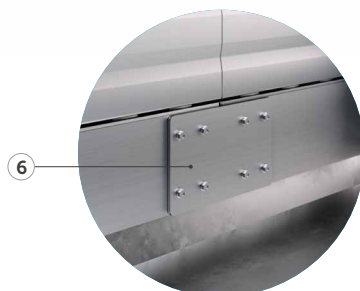
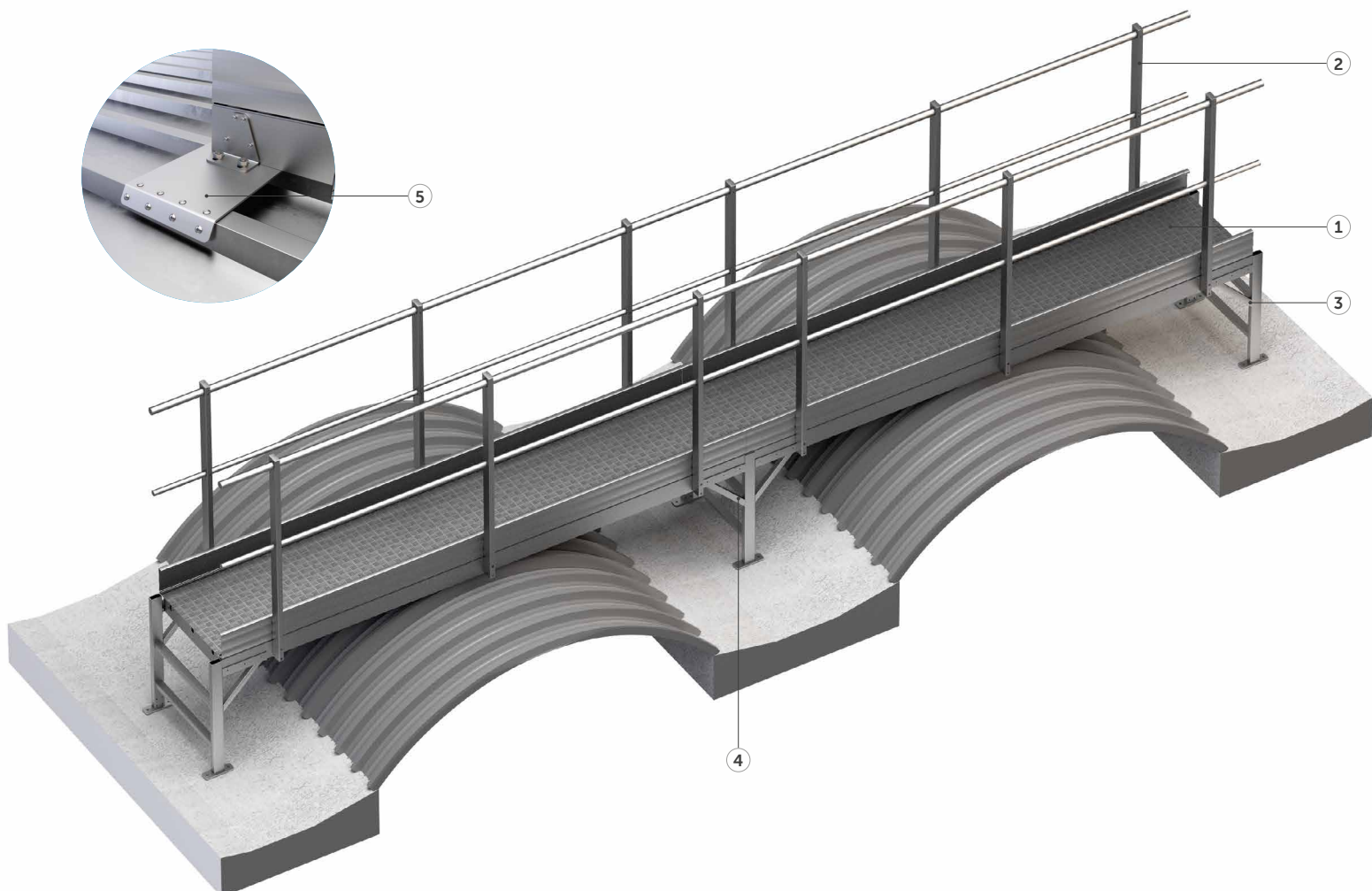

n.	CODE
1	WALK6 / WALK8
2	WALKG
3	WALKEND6 / WALKEND8
4	WALKINT6 / WALKINT8
5	WALKMET
6	WALKJUN
7	WALKBASE

## CODES AND DIMENSIONS

### WALKWAY MODULE

CODE	description	width (B)	length (L)
		[mm]	[mm]
WALK615	walkway module	600	1500
WALK620	walkway module	600	2000
WALK625	walkway module	600	2500
WALK630	walkway module	600	3000
WALK815	walkway module	800	1500
WALK820	walkway module	800	2000
WALK825	walkway module	800	2500
WALK830	walkway module	800	3000

Other lengths available on request.

### RAILING MODULE WITH OPTIONAL TOE BOARD\*

CODE	description	length (L)	no. of uprights included
		[mm]	
WALKG15	railing module with toe board	1500	2
WALKG20	railing module with toe board	2000	2
WALKG25	railing module with toe board	2500	3
WALKG30	railing module with toe board	3000	3

Other lengths available on request.

\*The code is for the single side.

### RAISED END SUPPORTS

CODE	description	width (B)	height (H)
		[mm]	[mm]
WALKEND6200	end support	600	200
WALKEND6300	end support	600	300
WALKEND6400	end support	600	400
WALKEND6500	end support	600	500
WALKEND6600	end support	600	600
WALKEND8200	end support	800	200
WALKEND8300	end support	800	300
WALKEND8400	end support	800	400
WALKEND8500	end support	800	500
WALKEND8600	end support	800	600

Other heights available on request.

### RAISED INTERMEDIATE SUPPORTS

CODE	description	width (B)	height (H)
		[mm]	[mm]
WALKINT6200	intermediate support	600	200
WALKINT6300	intermediate support	600	300
WALKINT6400	intermediate support	600	400
WALKINT6500	intermediate support	600	500
WALKINT6600	intermediate support	600	600
WALKINT8200	intermediate support	800	200
WALKINT8300	intermediate support	800	300
WALKINT8400	intermediate support	800	400
WALKINT8500	intermediate support	800	500
WALKINT8600	intermediate support	800	600

Other heights available on request.

### OTHER SUPPORTS AND JOINTS

CODE	description	frets pitch	height (H)
		[mm]	[mm]
WALKMET250	support for sandwich panels	250	55
WALKMET333	support for sandwich panels	300	55
WALKMET500	support for sandwich panels	500	55

CODE	description
WALKBASE	base support for direct fastening/bracket for WALKMET
WALKJUN	fastening joint for WALK module

Other components are available on request.

For the composition, use the handbook or the component spreadsheet, both available on our website: [www.rothoblaas.com](http://www.rothoblaas.com).

# WALKWAYS

## OVERLANE

### OVERPASS WALKWAY

D.LGS.81/08

EN  
14122-3

EN  
14122-2

#### LIGHT

Thanks to the prefabrication and lightness of aluminium, it can be easily transported and is simple to install.

#### ADJUSTABLE

With various lengths and widths of both the landing platform and the side steps, it provides a solution for overcoming any obstacle.

#### RELIABLE

The non-slip covering means difficult areas of roofs or machinery can be reached safely.

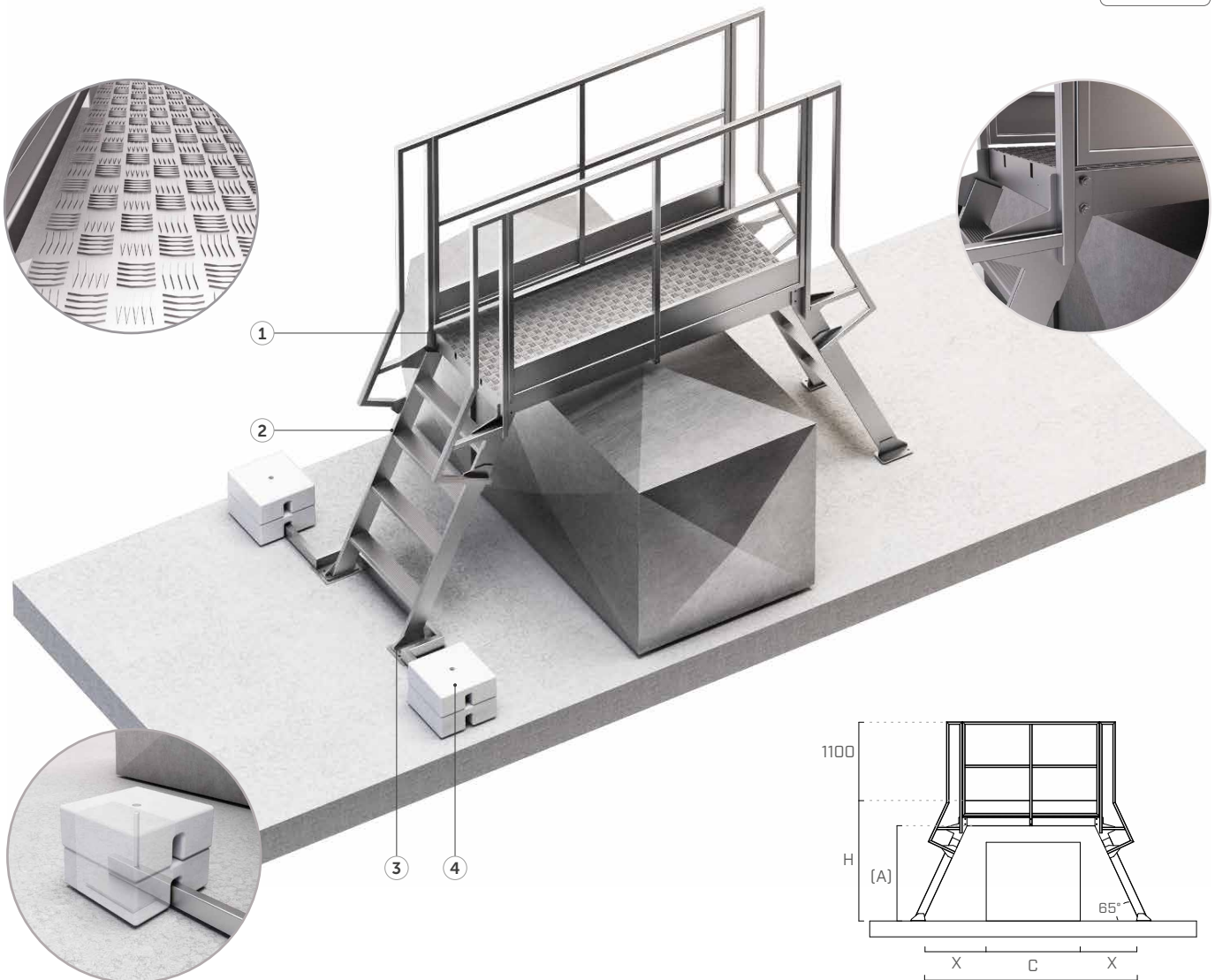

n. CODE

1 OVERPLAT6 / OVERPLAT8

2 OVERSTEP6 / OVERSTEP8

3 OVERBAR

4 OVERWEIGHT

## CODES AND DIMENSIONS

### LANDING WITH DOUBLE RAILING AND TOE BOARD

CODE	description	width (B)	length (L)	useful length (C)
		[mm]	[mm]	[mm]
OVERPLAT606	landing with railing	600	600	480
OVERPLAT608	landing with railing	600	800	680
OVERPLAT610	landing with railing	600	1000	880
OVERPLAT612	landing with railing	600	1200	1080
OVERPLAT614	landing with railing	600	1400	1280
OVERPLAT616	landing with railing	600	1600	1480
OVERPLAT618	landing with railing	600	1800	1680
OVERPLAT620	landing with railing	600	2000	1880
OVERPLAT622	landing with railing	600	2200	2080
OVERPLAT624	landing with railing	600	2400	2280
OVERPLAT806	landing with railing	800	600	480
OVERPLAT808	landing with railing	800	800	680
OVERPLAT810	landing with railing	800	1000	880
OVERPLAT812	landing with railing	800	1200	1080
OVERPLAT814	landing with railing	800	1400	1280
OVERPLAT816	landing with railing	800	1600	1480
OVERPLAT818	landing with railing	800	1800	1680
OVERPLAT820	landing with railing	800	2000	1880
OVERPLAT822	landing with railing	800	2200	2080
OVERPLAT824	landing with railing	800	2400	2280

Other dimensions are available on request.

### SIDE STEPS WITH RAILING\*

CODE	description	width (B)	height (H)	useful height (A)	depth (B)	no. of steps
		[mm]	[mm]	[mm]	[mm]	
OVERSTEP607	ladder module with railing	600	700	600	247	2
OVERSTEP610	ladder module with railing	600	950	850	364	3
OVERSTEP612	ladder module with railing	600	1200	1100	480	4
OVERSTEP615	ladder module with railing	600	1450	1350	597	5
OVERSTEP617	ladder module with railing	600	1700	1600	714	6
OVERSTEP620	ladder module with railing	600	1950	1850	820	7
OVERSTEP622	ladder module with railing	600	2200	2100	947	8
OVERSTEP807	ladder module with railing	800	700	600	247	2
OVERSTEP810	ladder module with railing	800	950	850	364	3
OVERSTEP812	ladder module with railing	800	1200	1100	480	4
OVERSTEP815	ladder module with railing	800	1450	1350	597	5
OVERSTEP817	ladder module with railing	800	1700	1600	714	6
OVERSTEP820	ladder module with railing	800	1950	1850	820	7
OVERSTEP822	ladder module with railing	800	2200	2100	947	8

Other sizes are available on request

\*One on each side of the overpass.

### ACCESSORIES FOR OVERPASS

CODE	description
OVERBAR	ballast holder for self-supporting fastening
OVERWEIGHT	22.5 kg concrete ballast (2 for each OVERBAR support)

#### EXAMPLE OF A COMPOSITION FOR A COMPLETE OVERPASS:

- n.1 OVERPLAT820
- n.2 OVERSTEP812

If self-supporting with ballast add:

- no.4 OVERBAR
- no.8 OVERWEIGHT

Other components are available on request.

For the composition, use the handbook or the component spreadsheet, both available on our website: [www.rothoblaas.com](http://www.rothoblaas.com).

# TEMPORARY RAILING BARRIERS

## EDGE TEMP 1

TEMPORARY RAILING  
ROOF SIDE



### CODES AND DIMENSIONS\*

CODE	standard	material	max. slope of use	max. spacing between supports [mm]	minimum thickness of fixture [mm]	substructure	weight [kg]	pcs
EDGETEMP1	EN 13374 Class A	zinc-plated steel	used as lateral protection support maximum slope 10° from horizontal	1400	from 80 to 192	 timber beam	8,80	1

\* The values indicated are derived from experimental tests carried out under the supervision of third party organisations according to the referenced standard. For a calculation report with minimum distances, according to the referenced normative requirements, the substructure must be verified by a qualified engineer before installation.

## EDGE TEMP 2

TEMPORARY RAILING  
FRONT COVER



### CODES AND DIMENSIONS\*

CODE	standard	material	max. slope of use	max. spacing between supports [mm]	minimum thickness of fixture [mm]	substructure	weight [kg]	pcs
EDGETEMP2	EN 13374 Class B	zinc-plated steel	maximum roof slope 30°	1400	from 80 to 200	 timber beam	9,00	1

\* The values indicated are derived from experimental tests carried out under the supervision of third party organisations according to the referenced standard. For a calculation report with minimum distances, according to the referenced normative requirements, the substructure must be verified by a qualified engineer before installation.

## EDGE TEMP 3

### TEMPORARY RAILING FOR HORIZONTAL EDGES



#### CODES AND DIMENSIONS\*

CODE	standard	material	max. slope of use	max. spacing between supports [mm]	substructure	weight [kg]	pcs
EDGETEMP3	EN 13374 Class A	zinc-plated steel	the slope of the working surface (impact sound surface) must be less than 10°	1400	 concrete	4,23	1



\* The values indicated are derived from experimental tests carried out under the supervision of third party organisations according to the referenced standard. For a calculation report with minimum distances, according to the referenced normative requirements, the substructure must be verified by a qualified engineer before installation.

## EDGE TEMP 4

### TEMPORARY UNIVERSAL RAILING WITH STEM



#### CODES AND DIMENSIONS\*

CODE	standard	material	max. slope of use	max. spacing between supports [mm]	minimum thickness of fixture [mm]	substructure	weight [kg]	pcs
EDGETEMP4	EN 13374 Class A	zinc-plated steel	the slope of the working surface (impact sound surface) must be less than 10°	1400	clamp max. opening 700	 timber	5,20	1
						 concrete		
						 steel		

\* The values indicated are derived from experimental tests carried out under the supervision of third party organisations according to the referenced standard. For a calculation report with minimum distances, according to the referenced normative requirements, the substructure must be verified by a qualified engineer before installation.

# LADDER HOOKS

## HANG TEMP

MOBILE LADDER HOOK



### CODES AND DIMENSIONS

CODE	material	B [mm]	H [mm]	L [mm]	weight [kg]	pcs
HANGTEMP	aluminium	445	300	1000	2,2	1

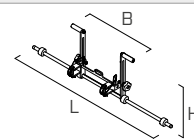

## HANG ROOF

LADDER HOOK  
FOR PITCHED ROOFS

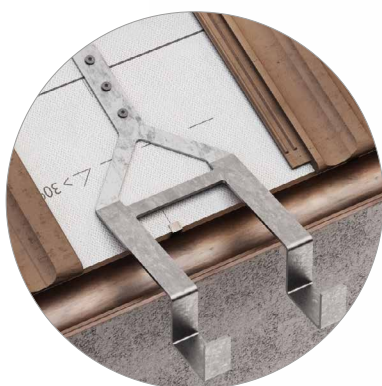

### CODES AND DIMENSIONS

CODE	material	B [mm]	H [mm]	L [mm]	weight [kg]	pcs
HANGROOF	zinc-plated steel	280	211	640	3,6	1
HANGROOFA2	AISI 304 stainless steel grade 1.4301	280	211	640	3,6	1

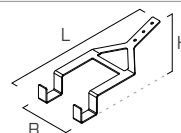



## HANG WALL

LADDER HOOK FOR WALL



### CODES AND DIMENSIONS

CODE	material	B [mm]	H [mm]	L [mm]	weight [kg]	pcs
HANGWALL	zinc-plated steel	128	196	280	3,5	1

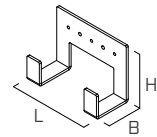

## HANG PLAIN

LADDER HOOK FOR FLAT SURFACES



### CODES AND DIMENSIONS

CODE	material	B [mm]	H [mm]	L [mm]	weight [kg]	pcs
HANGPLAIN	zinc-plated steel	212	116	280	3,5	1

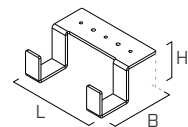

# HORIZONTAL NET

## HORIZONTAL POLYPROPYLENE FALL PROTECTION SAFETY NET

EN  
1263-1  
Tipo S

### SAFE

It requires a limited number of fastening systems (maximum distance between anchors: 2.5 m).

### MODULAR

Possibility of joining several nets together using HORCONNECT sewing rope to cover larger areas

### CAN BE PERSONALIZED

Also available in other colours by request (red, blue, white) and in personalised format for specific net sizes.



▼ *Installation of temporary polypropylene fall protection nets for securing a timber roof under construction*

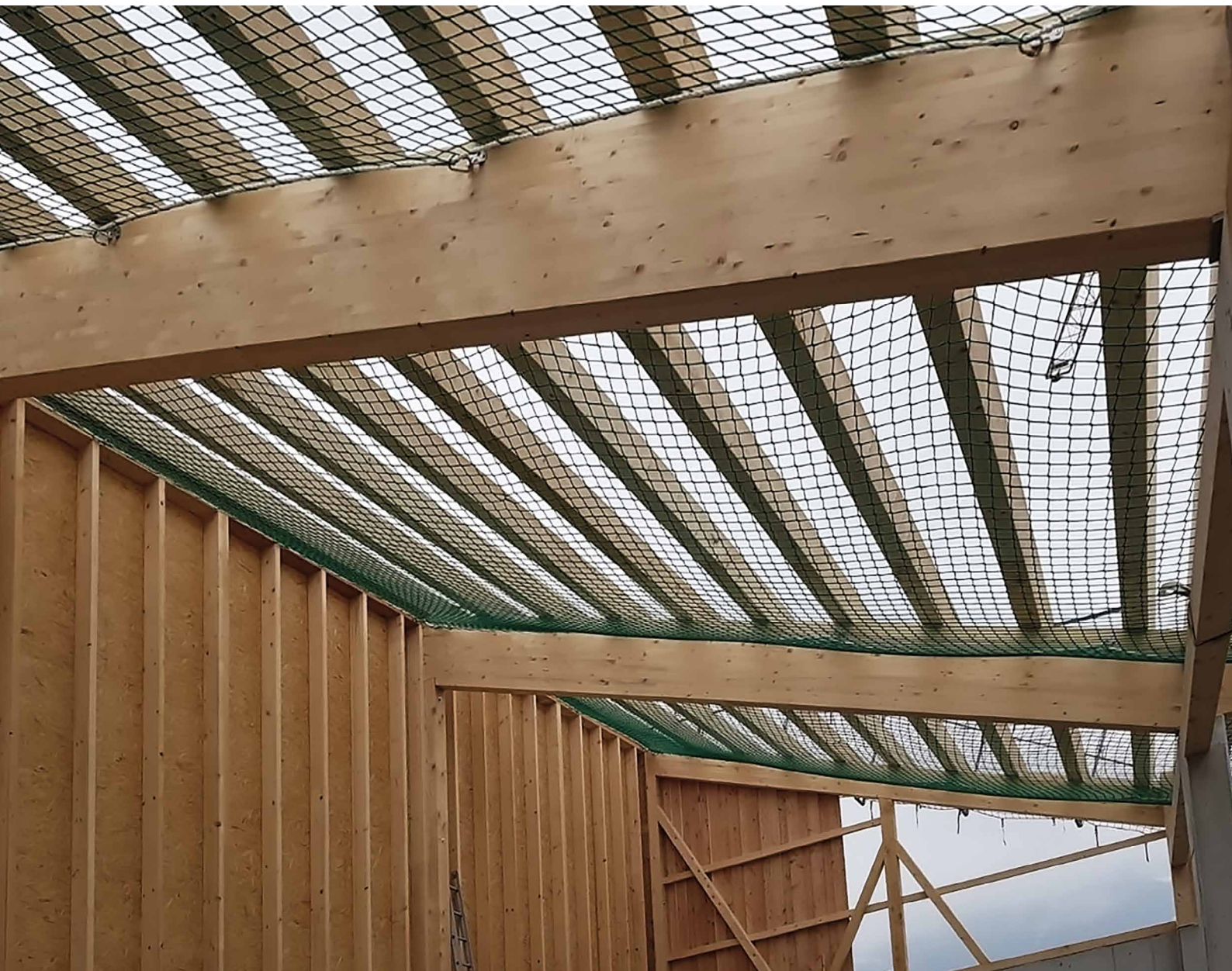

## ■ FIELDS OF APPLICATION

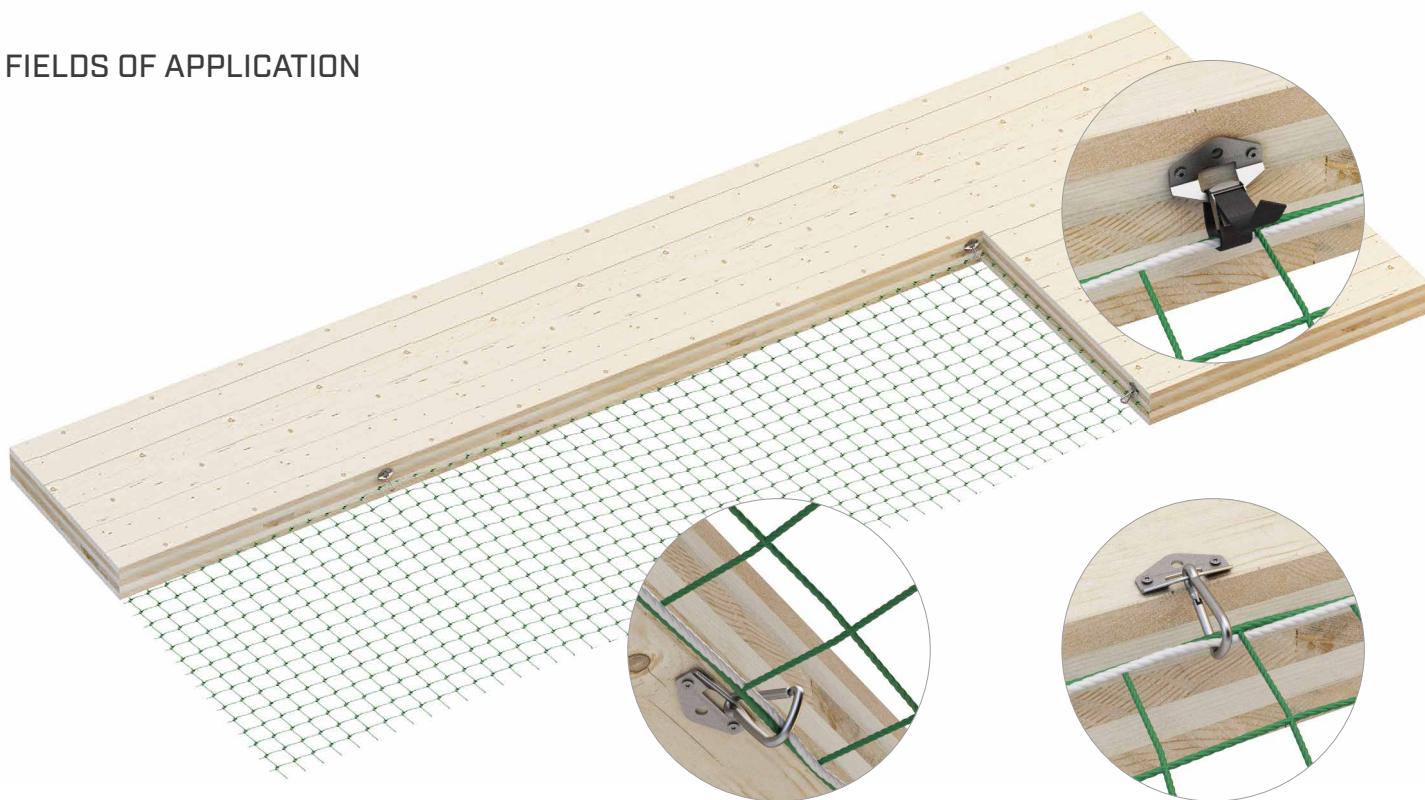

## ■ CODES AND DIMENSIONS

CODE	B [m]	L [m]	mesh [mm]	rope [mm]	weight [kg]	pcs
HOR510	5	10	100	Ø5	11,4	1
HOR610	6	10	100	Ø5	13,7	1
HOR7515	7,5	15	100	Ø5	25,7	1
HOR1010	10	10	100	Ø5	22,9	1

## COMPLEMENTARY PRODUCTS

CODE	description	dimensions [mm]	pcs	
HORHOOKC(*)	net hook for concrete	M12 x 110	1	
HORHOOKS(*)	net hook for steel	M12 x 130	1	
HORHOOKU(*)	base plate for net hooking	52 x 80 x 3	1	
HORHOOKCAR	carabiner for HORHOOKU	85,5 x 52 x 8	1	
HORHOOKSLI	webbing for HORHOOKU	300 x 25	1	
HORFIX	fastening cord per linear metre	Ø14	1	
HORCONNECT	sewing cord per linear metre	Ø6	1	

## FASTENING FOR HORHOOKU

substructure	fasteners [mm]	pcs	substructure	fasteners [mm]	pcs	substructure	fasteners [mm]	pcs
timber	HBS Ø6	2	concrete	AB1 / AB7 Ø10	1	steel	EKS M10 + ULS + MUT	1

(\*) Recommended fastening every 2,5 m.

# VERTICAL NET

## VERTICAL POLYPROPYLENE FALL PROTECTION SAFETY NET

EN  
1263-1  
Tipo U

### SAFE

Protection system for roof edges and scaffolding.

### FUNCTIONAL

Installation by inserting each individual link in the scaffold pipe or via fastening straps (optional).

### VERSATILE

Also available in other colours by request (red, blue, white).

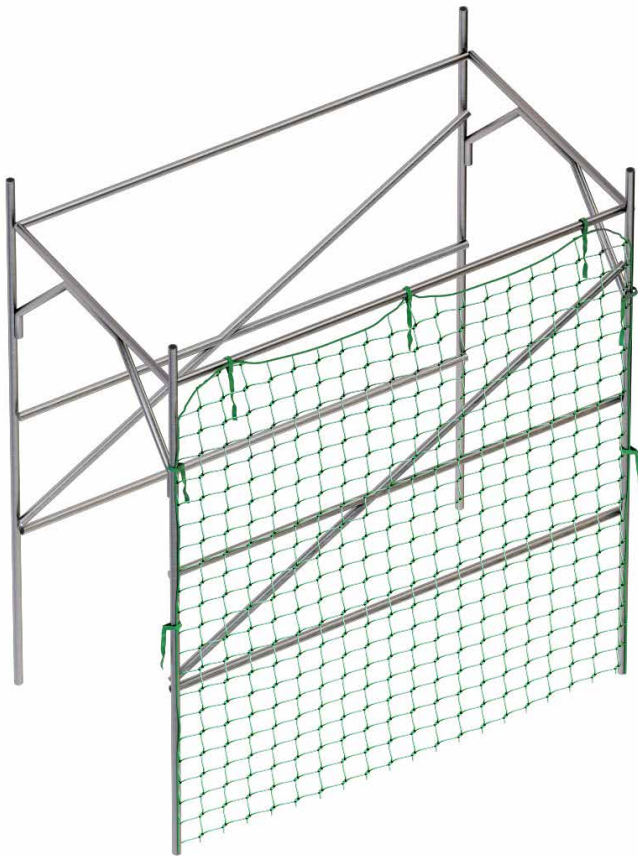

## CODES AND DIMENSIONS

CODE	B [m]	L [m]	mesh [mm]	rope [mm]	weight [kg]	pcs
VER210	2	10	100	Ø5	4,5	1

## COMPLEMENTARY PRODUCTS

CODE	description	spacing between belts fastening [mm]	L [mm]	pcs
VERBENT	fastening strap for side fall protection safety net	700	600	1

# FRAME NET

## FALL PROTECTION SAFETY NET WITH FRAME

EN  
13374C

### FUNCTIONAL

Possibility of installation on roofs with an inclination of up to 60°.

### FAST

Quick and easy assembly thanks to the few modular components.

### VERSATILE

Ideal for securing the roof when there is no possibility of installing external scaffolding or perimeter protection with external fastening.



## CODES AND DIMENSIONS

CODE	description	weight [kg]	pcs
FRAMENET	net with frame complete with quick straps	11	1
FRAMESUP	support for net with frame	9,2	1
FRAMEHOOK	hook for net with frame	1	1

The distance between the fastening brackets is max. 2.4 m. Each first module of the protection system (near each falling edge) must be fixed with two brackets and two supports, all other modules assembled next to each other and secured with quick fastening straps are fixed with only one support and fastening bracket



# PERSONAL PROTECTIVE EQUIPMENT

# PERSONAL PROTECTIVE EQUIPMENT







## PERSONAL PROTECTIVE EQUIPMENT

<b>KIT</b> .....	<b>172</b>
ROOF BASE .....	173
ROOF INT .....	173
ROOF PROFI .....	173
ROPE BASE.....	175
ROPE PROFI .....	175
SCA BASE .....	177
SCA PROFI .....	177
PLAT BASE .....	179
PLAT INT .....	179
PLAT PROFI .....	179
LAD BASE .....	181
LAD PROFI .....	181
STRUC BASE.....	183
STRUC PROFI.....	183
CORES BASE .....	185
CORES INT .....	185
CORES PROFI.....	185
<b>HELMETS</b> .....	<b>186</b>
PROTECTOR .....	186
ARCH .....	188
PAN .....	189
DIELECTRIC HELMET .....	189
<b>HARNESSES</b> .....	<b>190</b>
SPARTA .....	190
HESTIA .....	192
MAIA .....	193
BIA .....	193
METIS .....	194
METIS ANSI .....	194
IRIS.....	195
APATE .....	195
HERA BLACK .....	196
PLANK .....	196
<b>FALL PROTECTION AND POSITIONING</b> .....	<b>198</b>
DOUBLE SICUROPE .....	198
SCAFFOLD DUO .....	198
SICUROPE.....	198
POSITIONING .....	199
ENERGY.....	199
PLATROPE .....	199



<b>ROPES AND ACCESSORIES</b> .....	<b>200</b>	<b>ACCESSORIES</b> .....	<b>213</b>
LINOSTOP .....	200	GLASS 1 .....	213
ROPE 1 .....	200	GLASS 2 .....	213
ROPE 2 .....	200	HEADPHONE .....	213
EDGE .....	201	RSBAG .....	214
EDGEPRO .....	201	RBBAG .....	214
ROPE105 .....	202	ECO .....	215
ROPE11 .....	202	LATEX .....	215
		NITRAN .....	215
		NYLON .....	215
<b>RETRACTABLE DEVICES</b> .....	<b>203</b>	<b>TRIPODS AND CRANES</b> .....	<b>216</b>
FALL BLOCK .....	203	TRI .....	216
STRAP .....	203	DAV .....	218
		STRETCHER .....	221
<b>SELF-LOCKING DESCENDERS</b> .....	<b>204</b>	<b>HARNESSES   COMPARISON</b> .....	<b>222</b>
BACK .....	204	<b>CONNECTORS   COMPARISON</b> .....	<b>223</b>
ROPE BRAKE .....	204	<b>ACCESSORIES   COMPARISON</b> .....	<b>224</b>
ELEVATOR .....	205		
BELLY .....	205		
<b>DESCENDERS - POSITIONING</b> .....	<b>206</b>		
ROPE BRAKE 2 .....	206		
FOOT STEP .....	206		
EXTEND .....	207		
POLE .....	207		
<b>TEMPORARY ANCHOR SYSTEMS</b> .....	<b>208</b>		
BAND23 .....	208		
BAND35 .....	208		
RIG .....	208		
WEBAD .....	209		
LANSTECO .....	209		
<b>CONNECTORS</b> .....	<b>210</b>		
CLASSIC .....	210		
OVAL .....	210		
XXL .....	210		
HELICON .....	211		
FAST LINK .....	211		
<b>PULLEYS</b> .....	<b>212</b>		
SINGLE - DOUBLE .....	212		
LIFTING HELP .....	212		

# PPE STANDARDS

KIT	HELMETS	HARNESSES	FALL PROTECTION AND POSITIONING	ROPES AND ACCESSORIES	RETRACTABLE DEVICES
					
-	EN 397 ANSI Z.89.1 EN 166 EN 352-3 EN 50365	EN 361 EN 358 EN 813 EN 12275/A/C ANSI/ASSE Z359.11-2014	EN 355 EN 358 EN 353-2	EN 353-2 EN 354 EN 1891	EN 360 ATEX II 2G c T6

## EQUIPMENT CARE AND MAINTENANCE

### TEXTILE DEVICES



#### CUTS

A 2-mm edge cut reduces fabric resistance by up to 40%.



#### ULTRA VIOLET DEGRADATION

The sun and welding can damage textile components.



#### ABRASIONS

An abrasion on textile components acts just like a cut when fabric threads are torn.









#### SEAMS

Before each use it is essential to check that there are no loose, torn, worn or missing threads.



#### BURNS

Caused both by heat sources and by contact with chemical and corrosive substances or materials. In particular, nylon is usually damaged when in contact with acids, and polyester with alkaline substances.

DESCENDERS   SELF-LOCKING	DESCENDERS   POSITIONING	ANCHOR SYSTEMS	CONNECTORS	PULLEYS	ACCESSORIES	TRIPODS AND CRANES
						
EN 353-2 EN 567 EN 12841 ANSI/ISEA Z359.15-2014 EN 341	EN 341 EN 62193 EN 60832-1 EN 795:2012 B	EN 795:2012 B EN 354 EN 566 RfU CNB/P/11.114	EN 362 EN 12275 ANSI Z359.12	EN 12278	EN 166 EN 352-1 EN 388	EN 795:2012 B CEN/TS 16415:2013 EN 1496 EN 360

The care and maintenance of your equipment is essential for the safety of the user. Cuts, abrasions, burns and other signs of wear adversely affect safety: a damaged device may operate improperly and cause accidents, which can be avoided with effective preventive inspections.

## MECHANICAL DEVICES



### SIGNS OF WEAR

The frequent use of the device can determine accelerated wear. The frequency of checks must therefore be directly proportional to the frequency of use.



### DEFORMATION

Excessive loads or misuse may result in changes and breakdown of the device.



### LOOSENED PARTS

Before each use, check the device for integrity (loosened screws, signs of breakage, etc.).



### CORROSION AND OXIDATION

Keep the devices away from moisture and atmospheric agents as they may deteriorate their functions.

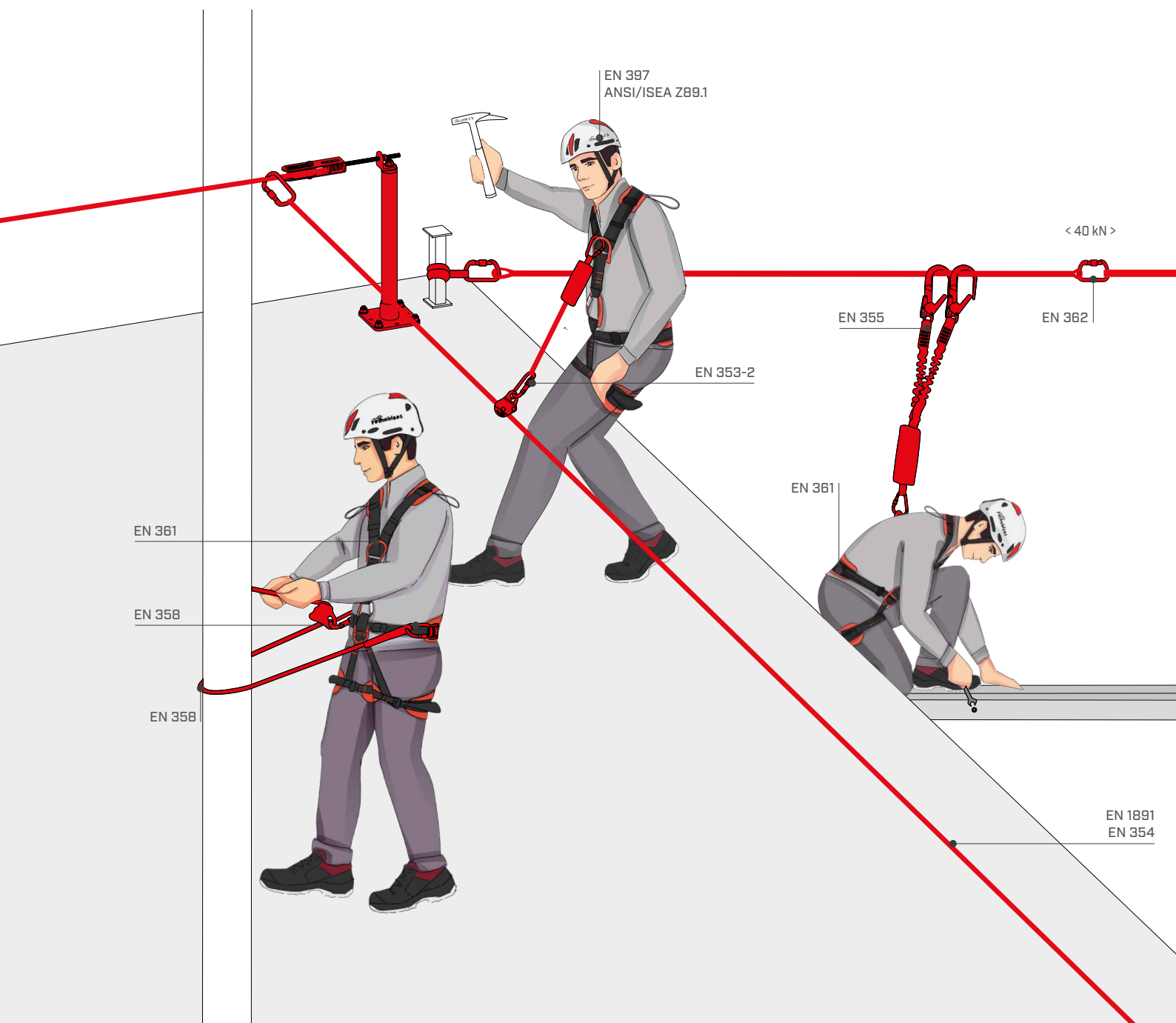

## WORK ON ROOFS

**WORK ON ROOFS** means all actions carried out on roofs. To work safely, the worker must be attached to a life line already installed on the ridge line. If this is not available, a temporary anchor line must be installed by a qualified worker.

A **FIXED ANCHOR LINE** must be made of certified devices, designed by a qualified professional and installed by a worker who has been adequately trained by the manufacturer. During this phase, the most important aspect is the selection of the type and number of fastenings to be used. Once installed, the anchor line must be tested and inspected on annually.

**TEMPORARY ANCHOR LINES** are used in situations where there is no possibility of creating an adequate anchor for a fixed anchor line.

## ROOF BASE

BASIC KIT FOR WORKING ON ROOF



FAST LINK



LINOSTOP



IRIS



RBBAG

CODE			page	pcs
ROOFBASE	RBBAG	backpack	214	1
	IRIS	complete harness for fall protection systems	195	1
	LINO10	guided type fall arrester with flexible anchor line	200	1
	FASTD	fast link in carbon steel, half-round "D" shape	211	1

## ROOF INT

INTERMEDIATE KIT FOR WORKING ON ROOF



FAST LINK



DOUBLE SICUROPE



LINOSTOP



METIS



RSBAG

CODE			page	pcs
ROOFINT	RSBAG	waterproof bag	214	1
	METISML	complete professional harness for fall protection systems	194	1
	LINO10	guided type fall arrester with flexible anchor line	200	1
	DSIC2	double arm rope with energy absorber	198	1
	FASTD	fast link in carbon steel, half-round "D" shape	211	1

## ROOF PROFI

PROFESSIONAL KIT FOR WORKING ON ROOF



BACK



ROPE1



SPARTA



RSBAG

CODE			page	pcs
ROOFPROFI	RSBAG	waterproof bag	214	1
	SPARTAML	complete professional harness for fall protection systems, positioning, rope access work	191	1
	ROPE115	semi-static rope with sewn eyelets and self-locking carabiner	200	1
	BACK	fall protection and positioning device	204	1

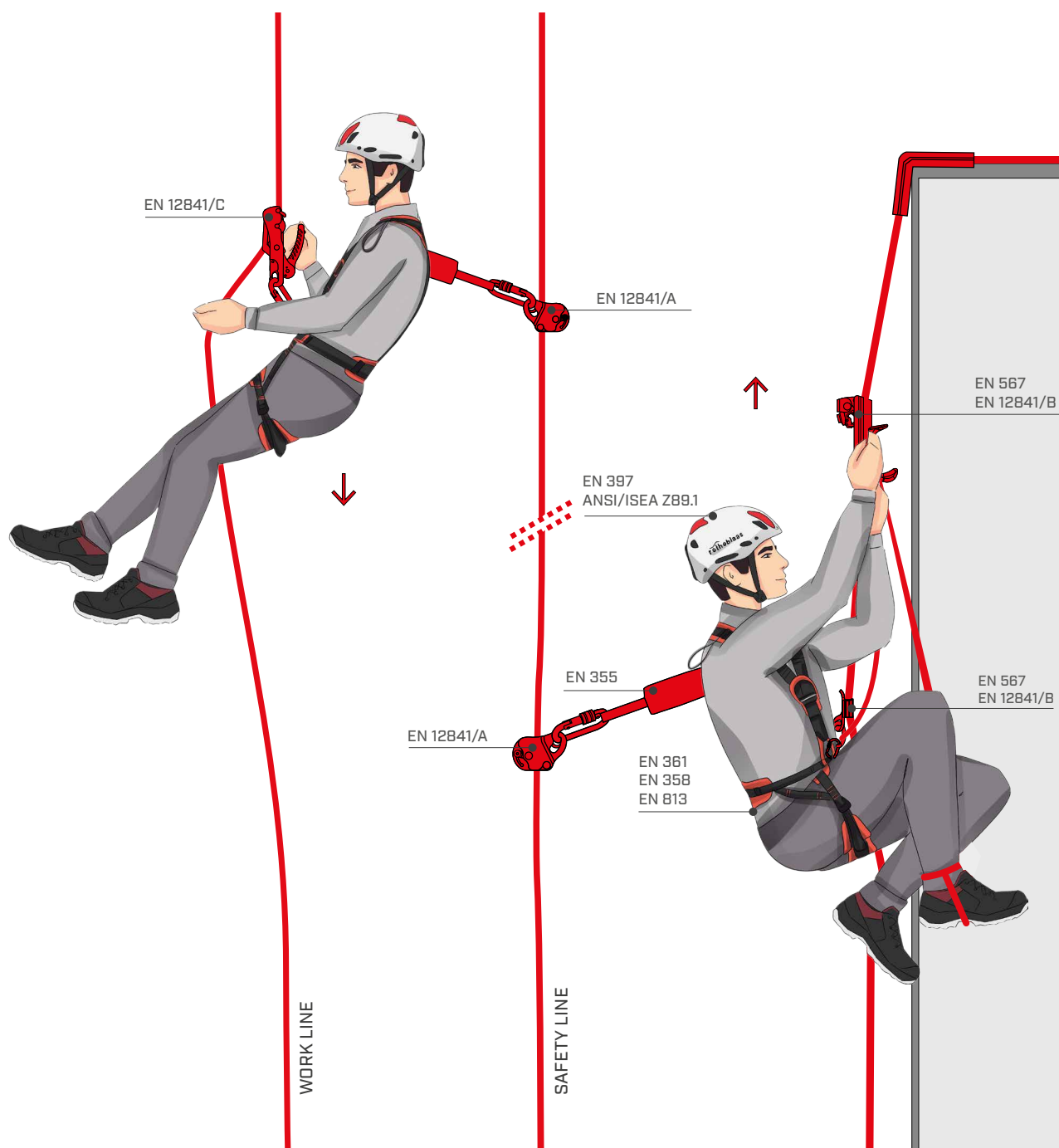

## WORK WITH DOUBLE ROPES

**WORK WITH ROPES** means situations where the worker must carry out short-term operations while freely hanging or working along a vertical wall or surface with an incline exceeding 30°. Due to their complexity, these jobs are performed by specialised workers with high level training provided by qualified entities or associations such as IRATA or SPRAT.

A rope is used when carrying out these operations, together with ascenders and descenders, which are devices that allow the worker to move up and down along the rope. A second rope must also be used, known as the "safety" rope, complete with a fall protection system which goes into action in the case the working rope breaks.

## ROPE BASE

BASE KIT FOR WORK WITH DOUBLE ROPE



ROPE BRAKE



BACK



SPARTA



RSBAG

CODE			page	pcs
ROPEBASE	RSBAG	waterproof bag	214	1
	SPARTAML	complete professional harness for fall protection systems, positioning, rope access work	191	1
	BACK	fall arrester	204	1
	ROPBRA	descender	204	1

## ROPE PROFI

PROFESSIONAL KIT FOR WORK WITH DOUBLE ROPE



BELLY



ROPE BRAKE



BACK



PLANK



HERA BLACK



RSBAG

CODE			page	pcs
ROPEPROFI	PLANK	seat for extended suspension work	196	1
	RSBAG	waterproof bag	214	1
	HERABLACKML	complete professional harness for fall protection, positioning and rope access work	196	1
	BACK	fall arrester	204	1
	ROPBRA	descender	204	1
	BELLY	Cam Clean rope lock	205	1

## WORK ON SCAFFOLDING

Scaffolding and trestles are CPE (Collective Protective Equipment) used to support workers and materials during construction at height.

During installation and removal of these structures, workers must use appropriate PPE and take various aspects into consideration, including the fall factor, vertical clearance and pendulum effect.

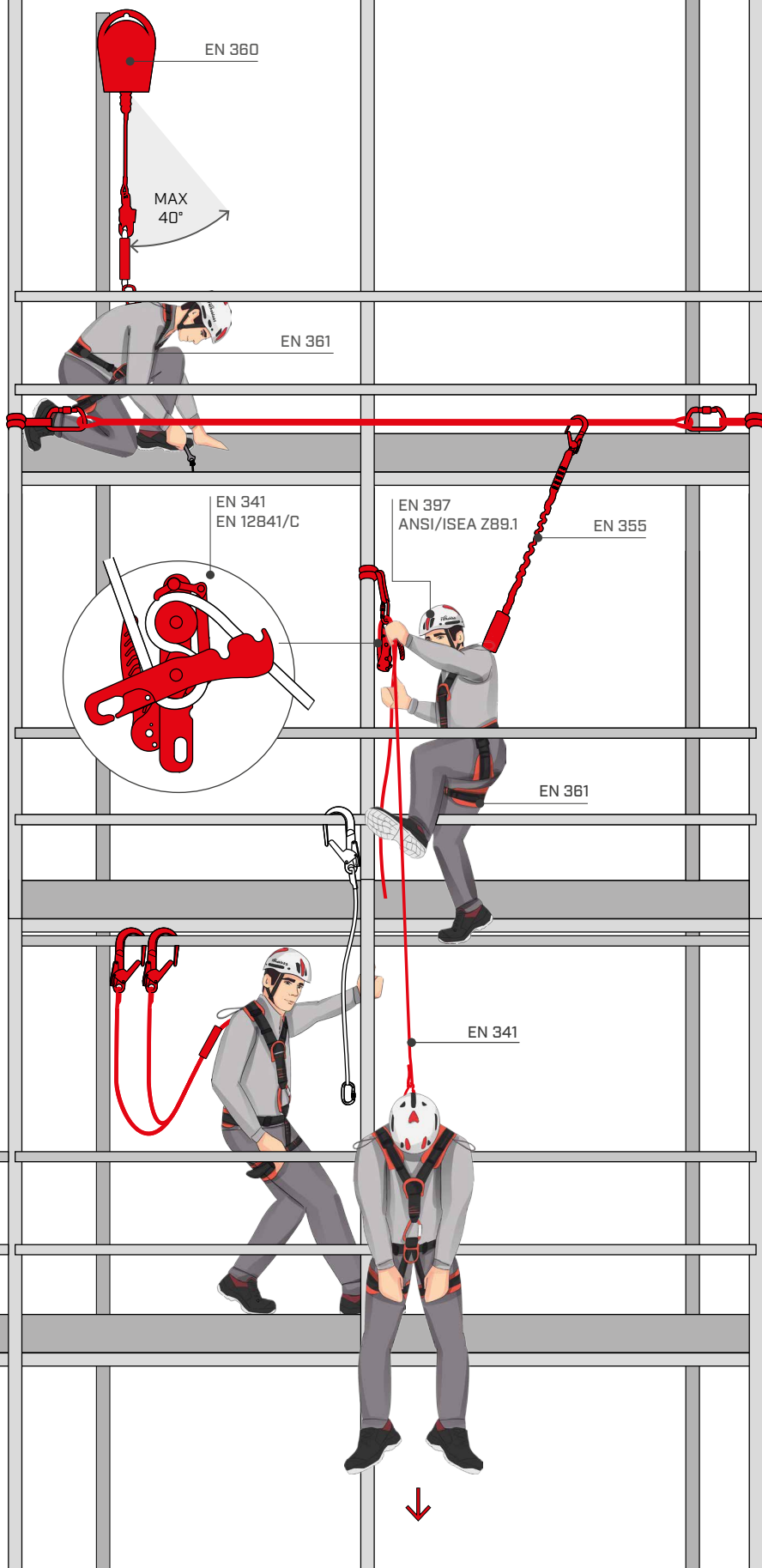



## SCA BASE

BASIC KIT FOR WORKING ON SCAFFOLDING



FAST LINK



ENERGY



IRIS



RBBAG

CODE			page	pcs
SCABASE	RBBAG	backpack	214	1
	IRIS	complete harness for fall protection systems	195	1
	ENERGY	adjustable rope with energy absorber	199	1
	FASTD	fast link in carbon steel, half-round "D" shape	211	1

## SCA PROFI

PROFESSIONAL KIT FOR WORKING ON SCAFFOLDING



SCAFFOLD DUO



MAIA



RSBAG

CODE			page	pcs
SCAPROFI	RSBAG	waterproof bag	214	1
	MAIAMXL	complete professional harness for fall protection, positioning and rope access work	193	1
	SCA15	double arm rope with energy absorber	198	1

## WORK ON PLATFORMS

Aerial work platforms are often used to reach working areas at height. These platforms are not without falling risks for workers, who could be thrown past the side barriers due to swinging while the platform is moving towards the working area. Therefore, it is recommended that an anchoring system is used which secures the worker to the platform itself.

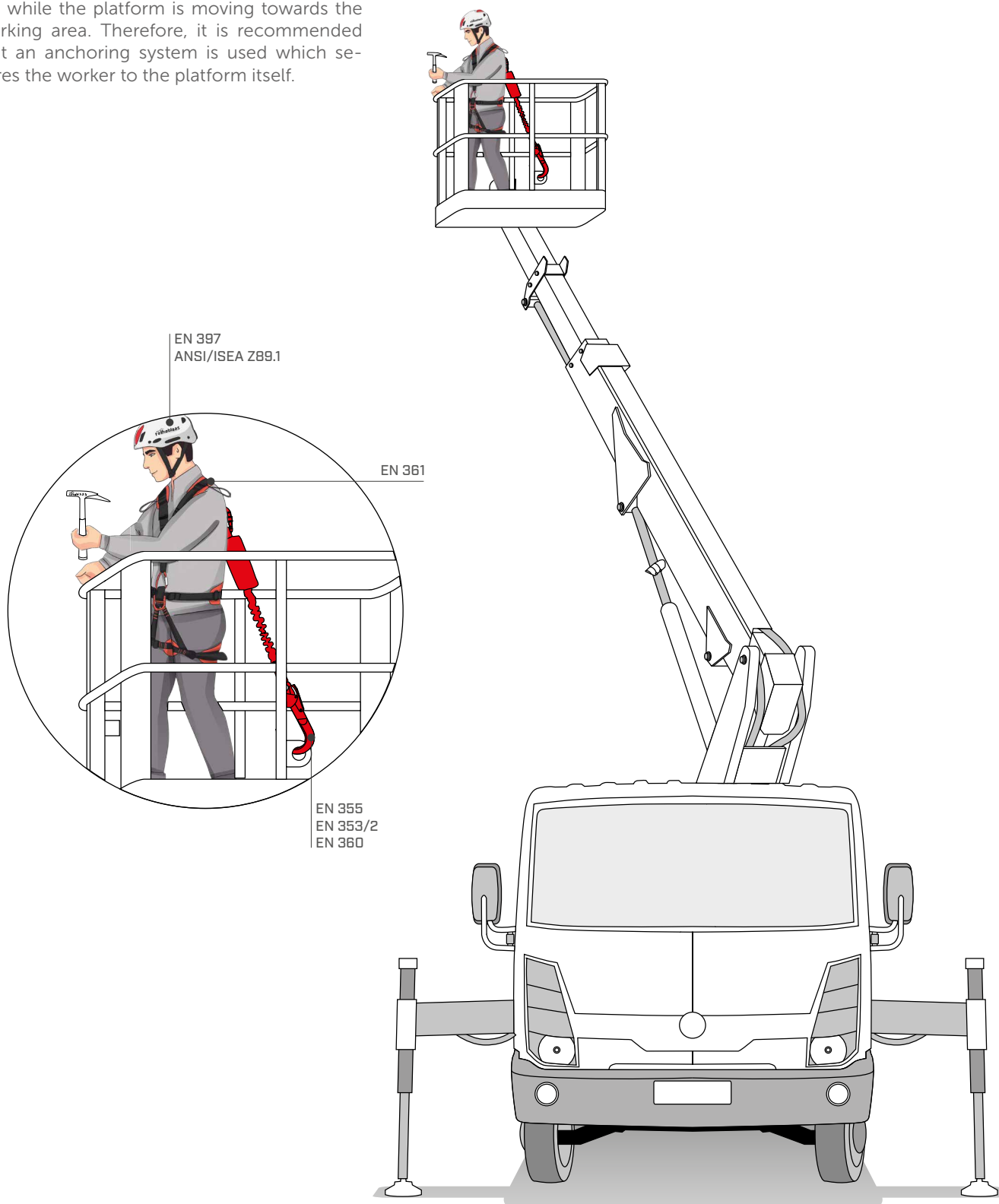

## PLAT BASE

BASE KIT FOR PLATFORM WORK



FAST LINK



ENERGY



IRIS



RBBAG

CODE			page	pcs
PLATBASE	RBBAG	backpack	214	1
	IRIS	complete harness for fall protection systems	195	1
	ENERGY	adjustable rope with energy absorber	199	1
	FASTD	fast link in carbon steel, half-round "D" shape	211	1

## PLAT INT

INTERMEDIATE KIT FOR PLATFORM WORK



FAST LINK



PLATROPE



HESTIA



RSBAG

CODE			page	pcs
PLATINT	RSBAG	waterproof bag	214	1
	HESTIAMXL	complete harness for fall protection systems	192	1
	PLATROPE	adjustable rope with energy absorber for platforms	199	1
	FASTD	fast link in carbon steel, half-round "D" shape	211	1

## PLAT PROFI

PROFESSIONAL KIT FOR PLATFORM WORK



FAST LINK



STRAP



METIS



RSBAG

CODE			page	pcs
PLATPROFI	RSBAG	waterproof bag	214	1
	METISML	complete professional harness for fall protection systems	194	1
	STRAP2	retractable device	203	1
	FASTD	fast link in carbon steel, half-round "D" shape	211	1

## WORK ON LADDERS

Ladders can be used to access working areas. They can be fixed or portable; in both cases they must be certified.

Fixed ladders are typically used in industrial environments where access to certain areas is very frequent for the performance of ordinary maintenance, while portable ladders are used for extraordinary maintenance. It should be remembered that whenever possible, the use of an aerial platform or scaffolding is preferable to the use of a ladder. In all cases, no worker should ascend a ladder without adequate personal protection equipment.

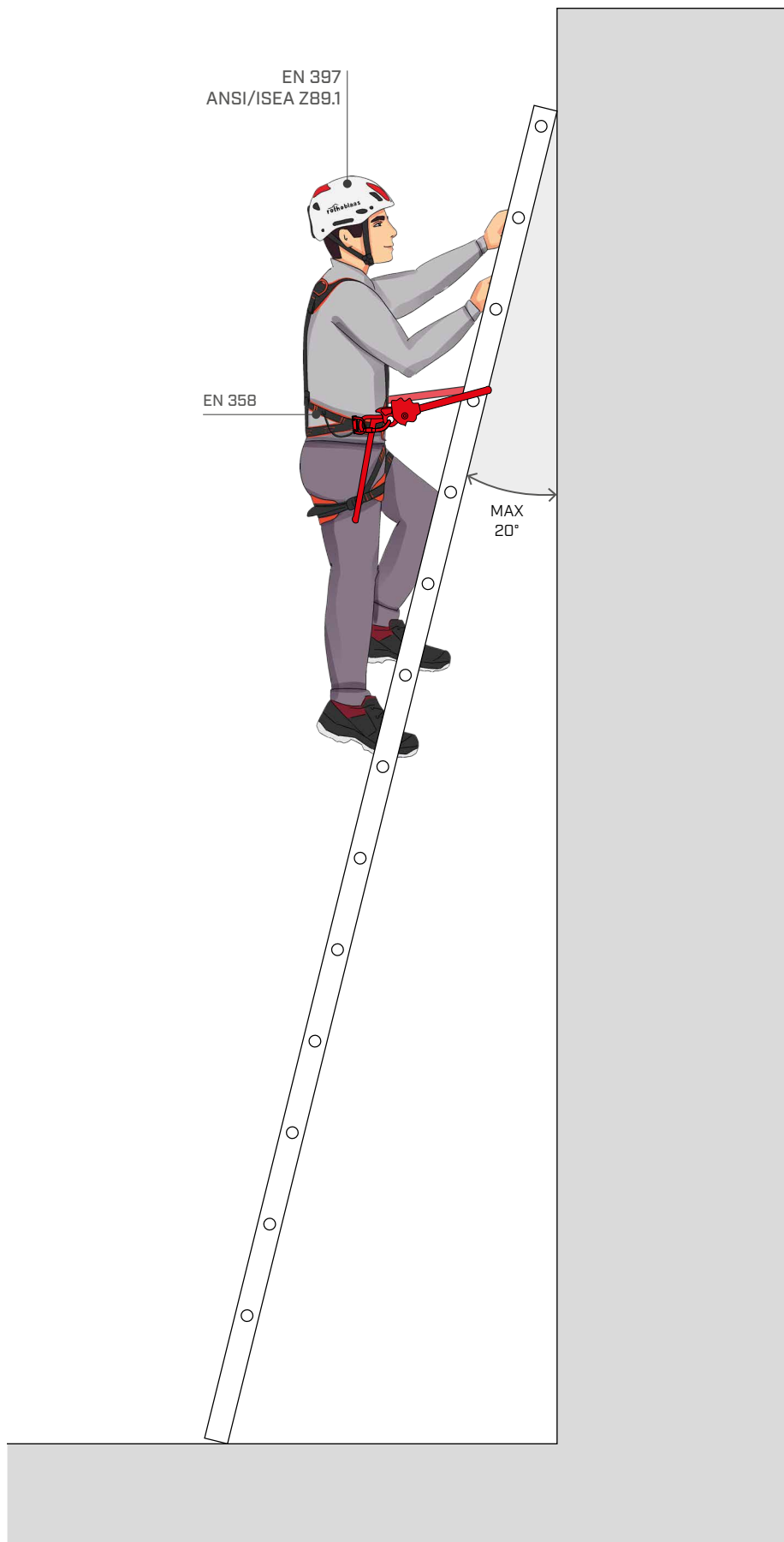

# LAD BASE

BASE KIT FOR WORKING ON LADDERS



POSITIONING



MAIA



RBBAG

CODE			page	pcs
LADBASE	RBBAG	backpack	214	1
	MAIAMXL	complete professional harness for fall protection, positioning and rope access work	193	1
	POS2	adjustable positioning lanyard	199	1

# LAD PROFI

PROFESSIONAL KIT FOR WORKING ON LADDERS



EXTEND



BACK



ROPE1



SPARTA



RSBAG

CODE			page	pcs
LADPROFI	RSBAG	waterproof bag	214	1
	SPARTAML	complete professional harness for fall protection systems, positioning, rope access work	191	1
	ROPE110	semi-static rope with sewn ends and automatic carabiner	200	1
	BACK	fall arrester	204	1
	EXTENSIONPOLE	telescopic bar	207	1
	EXTENSIONHOOK	hook for hanging	207	1
	EXTENSIONHEAD	work hook	207	1

## WORK ON PYLON

Pylons are metal structures typically used to support telecommunication and cableway systems, which generally present stability problems for workers due to the limited surface area available for foot placement. It is often necessary to access pylons to carry out ordinary maintenance on the pylon itself. In most cases, the pylon will have vertical life lines that assist the worker in climbing up. Based on the work to be done, it is possible to work using a fall protection or positioning system. When an anchor line is not present, the technique chosen for the ascent will determine the PPE to be adopted.

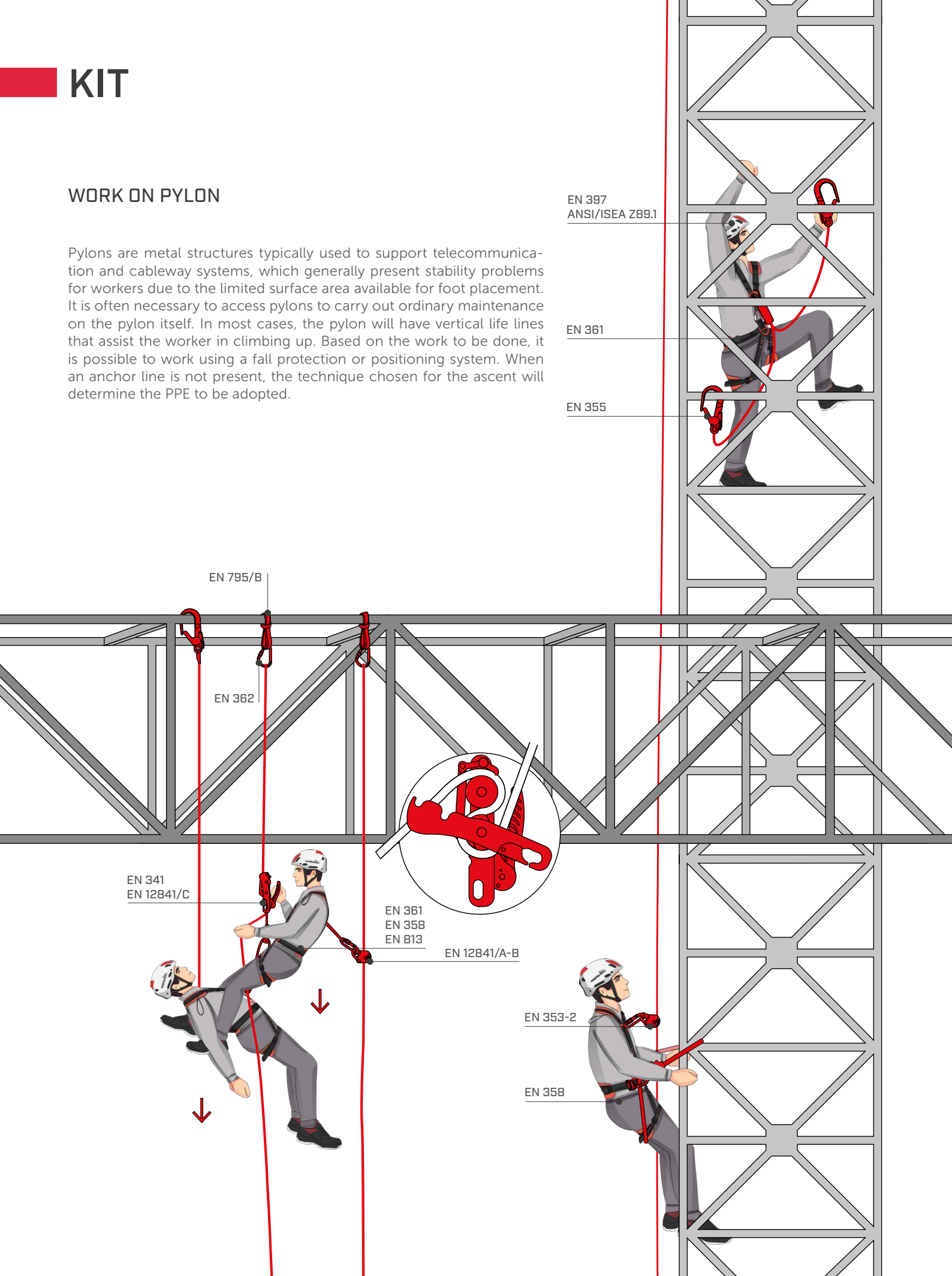

EN 397  
ANSI/ISEA Z89.1

EN 361

EN 355

EN 795/B

EN 362

EN 341  
EN 12841/C

EN 361  
EN 358  
EN 813

EN 12841/A-B

EN 353-2

EN 358

## STRUC BASE

BASE KIT FOR WORKING ON ELECTRICITY PYLON



BAND35



SCAFFOLD DUO



LINOSTOP



MAIA



RSBAG

CODE			page	pcs
STRUCBASE	RSBAG	waterproof bag	214	1
	MAIAMXL	complete professional harness for fall protection systems, positioning, rope access work	193	1
	LINO20	guided type fall arrester with flexible anchor line	200	1
	SCA15	double arm rope with energy absorber	198	1
	BAND35120	textile ring anchor with 1.2 m wear indicator max. load 35 kN	208	1

## STRUC PROFI

PROFESSIONAL KIT FOR WORKING ON ELECTRICITY PYLON



BACK



SCAFFOLD DUO



ROPE1



SPARTA



RSBAG

CODE			page	pcs
STRUCPROFI	RSBAG	waterproof bag	214	1
	SPARTAML	complete professional harness for fall protection systems, positioning, rope access work	191	1
	ROPE130	semi-static rope with sewn ends and automatic carabiner	200	1
	SCA15	double arm rope with energy absorber	198	1
	BACK	fall arrester	204	1

## WORK IN CONFINED SPACE

For a correct assessment, consider:

- The type of activity
- The type of work environment
- The materials and equipment to be used and suitable PPE
- The suitability of employees

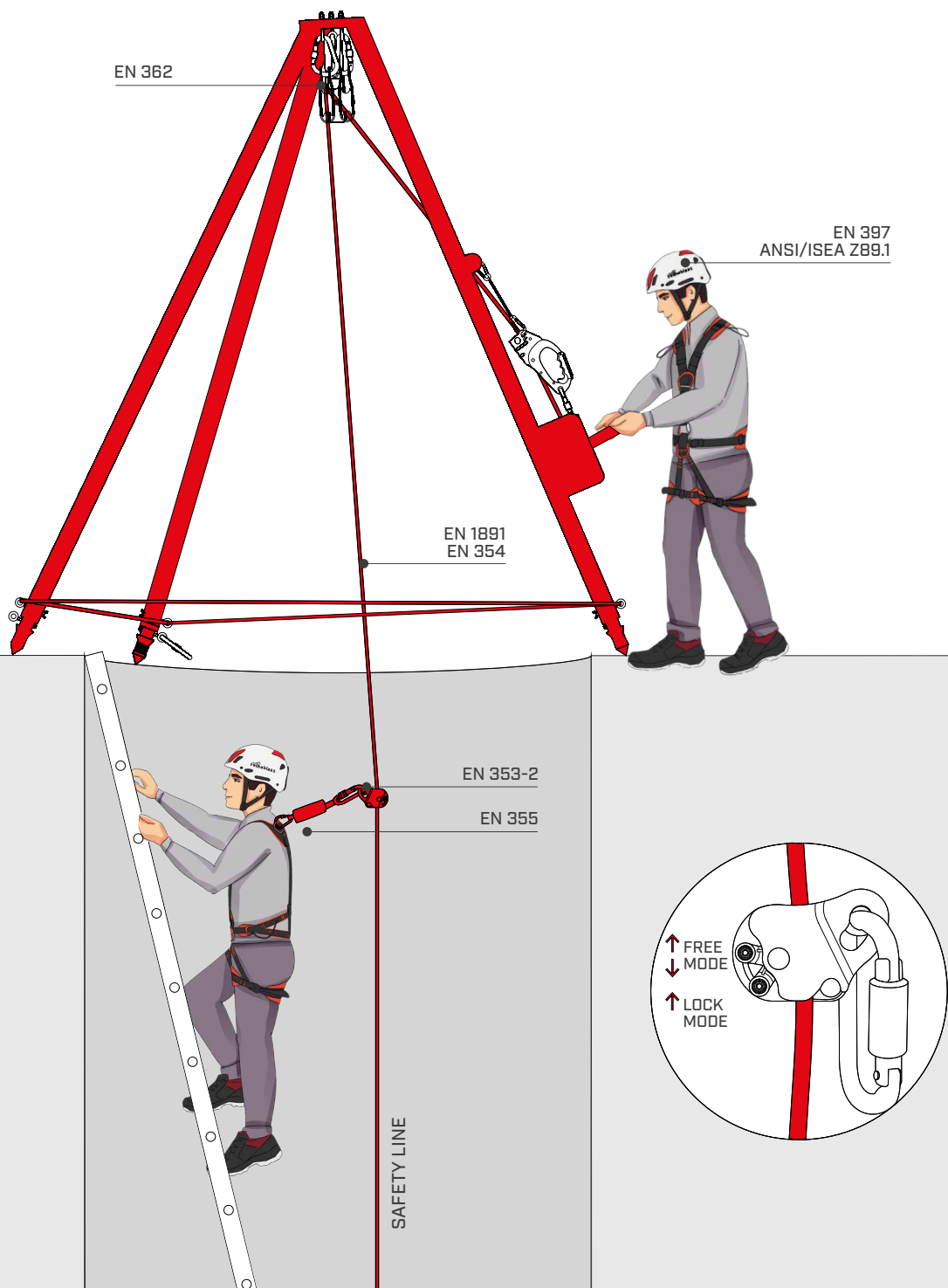



## CORES BASE

BASE KIT FOR WORKING IN CONFINED SPACE



FAST LINK



IRIS



RBBAG

CODE			page	pcs
CORESBASE	RBBAG	backpack	214	1
	IRIS	complete harness for fall protection systems	195	1
	FASTD	fast link in carbon steel, half-round "D" shape	211	1

## CORES INT

INTERMEDIATE KIT FOR WORKING IN CONFINED SPACE



BACK



ROPE1



BIA



RSBAG

CODE			page	pcs
CORESINT	RSBAG	waterproof bag	214	1
	BIAML	complete professional harness for fall protection systems	193	1
	ROPE115	semi-static rope with sewn ends and automatic carabiner	200	1
	BACK	fall arrester	204	1

## CORES PROFI

PROFESSIONAL KIT FOR WORKING IN CONFINED SPACE



BAND23



ELEVATOR



BACK



ROPE BRAKE



ROPE1



RSBAG

CODE			page	pcs
CORESPROFI	RSBAG	waterproof bag	214	1
	ROPE120	semi-static rope with sewn ends and automatic carabiner	200	1
	ROPBRA	descender	204	1
	BACK	fall arrester	204	1
	ELEL	moveable rope lock for ascent	205	1
	BAND23120	1.2 textile ring anchor max. load 23 kN	208	1

# HELMETS

## I PROTECTOR

HELMET FOR WORK AT HEIGHT, ON CONSTRUCTION SITE OR IN INDUSTRIAL AREAS

- Adjustable head wrap even when wearing gloves
- Positioning hooks for head lamp installation
- Pre-drilled shell for installation of visor and anti-noise earphones with specific accessories

EAC CE



## COMPONENTS



### CODES AND CHARACTERISTICS

CODE	standard	description	material	weight [g]	colour	size	pcs
PRO	CE - EN 397	PROTECTOR white	ABS	385	○	UNI 52 - 64 cm	1
PRONEC	CE - EN 397	PROTECTOR with nape cover	ABS	385	○	UNI 52 - 64 cm	1
PROORA	CE - EN 397	PROTECTOR orange	ABS	385	●	UNI 52 - 64 cm	1
PRORED	CE - EN 397	PROTECTOR red	ABS	385	●	UNI 52 - 64 cm	1
PROYEL	CE - EN 397	PROTECTOR yellow	ABS	385	●	UNI 52 - 64 cm	1
PROYELHV	CE - EN 397	PROTECTOR high visibility	ABS	385	●	UNI 52 - 64 cm	1
PROBLA	CE - EN 397	PROTECTOR black	ABS	385	●	UNI 52 - 64 cm	1
PROBLASOFT	CE - EN 397	PROTECTOR rubberised black	ABS	390	●	UNI 52 - 64 cm	1

### COMPLEMENTARY PRODUCTS

CODE	standard	description	material	weight [g]	colour	pcs
VISTRA	CE - EN 166	clear visor	polycarbonate	80	○	1
VISDAR	CE - EN 166	smoked visor	polycarbonate	80	●	1
1 VISTRALON	CE - EN 166	long visor for helmet	polycarbonate	125	○	1
VISTRE	CE - EN 1731	mesh visor for helmet	nylon	70	●	1
EAR26	CE - EN 352-3	set of earmuffs - 26 dB	-	185	●	1
2 EAR30	CE - EN 352-3	set of earmuffs - 30 dB	-	216	●	1
EAR32	CE - EN 352-3	set of earmuffs - 32 dB	-	245	●	1
3 EARADA	-	earmuffs adapter for PROTECTOR	-	-	-	1
GEARPRO	-	spare head wrap	-	16	●	1
PADPRO	-	spare padding	-	26	●	1
NEC	-	neck protector	-	-	-	1

CODE	description	output [lumen]	depth of light beam [m]	weight [g]	colour	battery life	pcs
LIGHT	compact light with 7 modes	122	120	56	●	180	1
LIGHTSOS	ultra compact light with 4 modes for use	25	25	24	●	96	1

# HELMETS

## ARCH

EAC CE

### HELMET FOR WORKPLACE SAFETY, ON INDUSTRY AND CONSTRUCTION

- Comfortable, well-ventilated lining for a perfect fit, removable and washable padding
- It allows visor and earmuffs to be attached thanks to the integrated coupling in the shell
- Provided with 4 durable light holders to attach a head lamp



#### CODES AND CHARACTERISTICS

CODE	standard	material	size	colour	weight [g]	pcs
ARCH	CE - EN 397 - ANSI/ISEA 9.1 - EAC	ABS	UNI 52 - 62 cm	○	385	1
ARCHYEL	CE - EN 397 - ANSI/ISEA 9.1 - EAC	ABS	UNI 52 - 62 cm	●	385	1

#### COMPLEMENTARY PRODUCTS

	CODE	standard	description	material	colour	weight [g]	pcs
1 VISOR	VISTRA	CE - EN 166	clear visor	polycarbonate	○	80	1
	VISDAR	CE - EN 166	smoked visor	polycarbonate	●	80	1
	VISTRALON	CE - EN 166	long visor for helmet	polycarbonate	○	125	1
	VISTRE	CE - EN 1731	mesh visor for helmet	nylon	●	70	1
2 EAR	EAR26	CE - EN 352-3	set of earmuffs - 26 dB	-	●	185	1
	EAR30	CE - EN 352-3	set of earmuffs - 30 dB	-	●	216	1
	EAR32	CE - EN 352-3	set of earmuffs - 32 dB	-	●	245	1
	NEC	-	neck protector	-	-	-	1

CODE	description	output [lumen]	depth of light beam [m]	battery life	colour	weight [g]	pcs
LIGHT	compact light with 7 modes	122	120	180	●	56	1
LIGHTSOS	ultra compact light with 4 modes for use	25	25	96	●	24	1

## PAN

CE

### HELMET FOR WORKPLACE SAFETY, ON INDUSTRY AND CONSTRUCTION

- The nylon trappings include a rapid adjustment system
- Padded chin strap, adjustable and quick-release
- Economical helmet for everyday work on the construction site



#### CODES AND CHARACTERISTICS

CODE	standard	description	material	colour	weight [g]	size	pcs
PAN	CE - EN 397	white helmet	ABS	○	396	UNI 51 - 63 cm	1
PANORA	CE - EN 397	orange helmet	ABS	●	396	UNI 51 - 63 cm	1
PANYEL	CE - EN 397	yellow helmet	ABS	●	396	UNI 51 - 63 cm	1

## DIELECTRIC HELMET

CE

### DIELECTRIC HELMET FOR WORKPLACE SAFETY, ON INDUSTRY AND CONSTRUCTION

- Ensures insulation up to **1000 volts**
- Equipped with quick-release buckle and adjustable, removable chin-strap
- Already present in the shell are the housings for headphones and visor



#### CODES AND CHARACTERISTICS

CODE	standard	material	colour	weight [g]	size	pcs
DIHELM	CE - EN 397 - EN 50365	ABS	○	390	UNI 54 - 62 cm	1

# HARNESSES

## SPARTA



COMPLETE PROFESSIONAL HARNESS FOR FALL PROTECTION SYSTEMS, POSITIONING, ROPE ACCESS WORK

- Large padding for maximum comfort during use, lightened waistband padding to increase breathability
- Equipped with three anchor points (ventral, sternal and dorsal) and two lateral positioning rings, all in light alloy
- The upper part can be completely disconnected from the lower part for inspection and cleaning purposes
- Two special passages are provided on the shoulder straps for connecting the system for vertical recovery

▼ *The SPARTA harness used with a safety lanyard for working on a timber roof*





FRONT



REAR

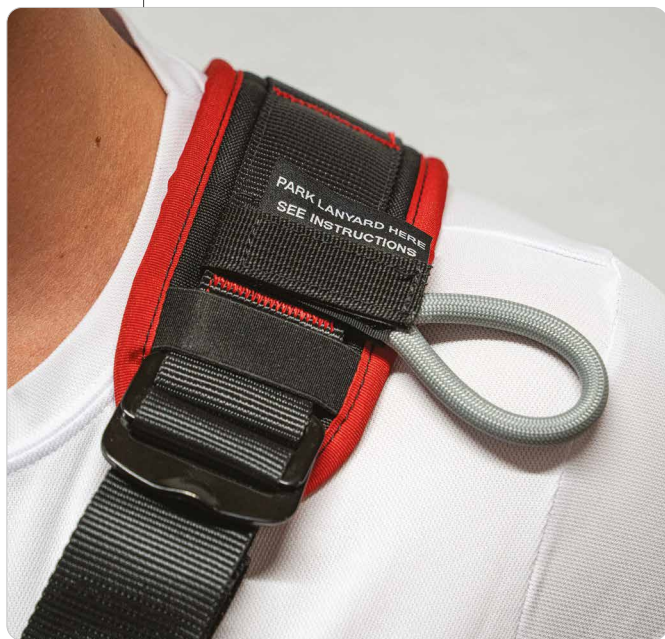

Special textile rings on the shoulder straps for storing fall arrest connectors when not in use. These rings are easy to remove thanks to the Velcro fastening.

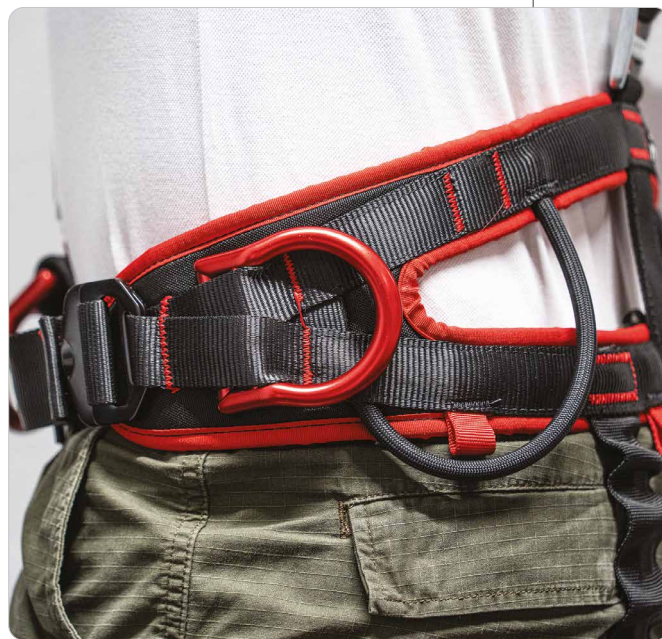

Harness equipped with 2 foldable lateral positioning rings in light alloy.

**CODES AND CHARACTERISTICS**

CODE	standard	A [cm]	B [cm]	size	weight [g]	pcs
SPARTAS	CE - EN 361 - EN 358 - EN 813 EN 12277/A/C	76/94	50/60	S	1650	1
SPARTAML	CE - EN 361 - EN 358 - EN 813 EN 12277/A/C	84/102	58/66	M/L	1700	1
SPARTAXL	CE - EN 361 - EN 358 - EN 813 EN 12277/A/C	90/126	60/74	XL	1750	1

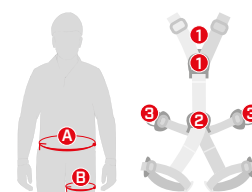

- 1. EN 361 | 15 kN
- 2. EN 358 - EN 813 | 15 kN
- 3. EN 358 | 15 kN

# HARNESSES

## HESTIA



### COMPLETE HARNESS FOR FALL PROTECTION SYSTEMS

- Three quick close buckles, pectoral and leg, for fast and effective placement
- Dorsal section and legs padded to ensure excellent comfort for workers
- Front tool holder at sternum
- Practical and easily placed work harness, thanks to quick open/close buckles
- Dorsal section and legs padded to ensure excellent comfort for workers

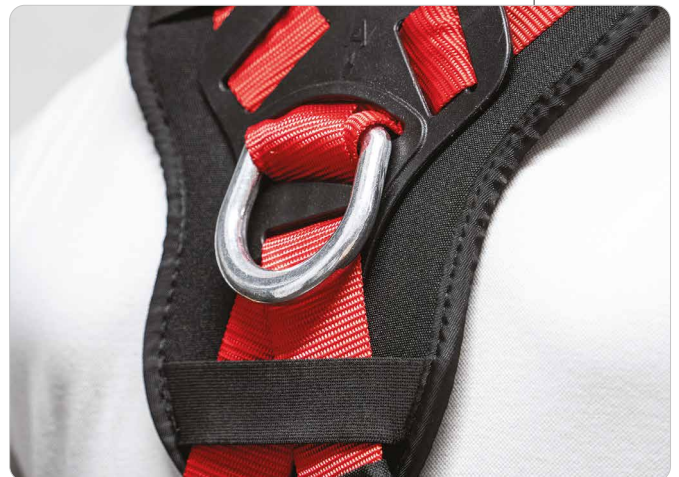

#### CODES AND CHARACTERISTICS

CODE	standard	A [cm]	B [cm]	C [cm]	size	weight [g]	pcs
HESTIAS	CE - EN 361	70/90	75/110	40/60	S	1550	1
HESTIAMXL	CE - EN 361	85/100	85/120	50/75	M/XL	1650	1
HESTIAXXL	CE - EN 361	100/130	90/140	60/85	XXL	1750	1

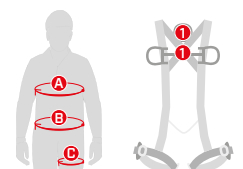

1. EN 361 | 15 kN



# MAIA



## COMPLETE PROFESSIONAL HARNESS FOR FALL PROTECTION SYSTEMS, POSITIONING, ROPE ACCESS WORK

- The elastic straps guarantee excellent fit
- Equipped with plastic material holder rings and four tool nodes
- Equipped with three anchor points (ventral, sternal and dorsal) plus lateral positioning rings



### CODES AND CHARACTERISTICS

CODE	standard	A [cm]	B [cm]	C [cm]	size	weight [g]	pcs
MAIAS	CE - EN 361 - EN 358 EN 813	80/142	42/75	-	S	1720	1
MAIAMXL	CE - EN 361 - EN 358 EN 813	-	82/144	44/77	M/XL	1820	1

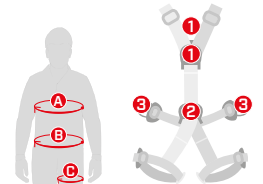

1. EN 361 | 15 kN
2. EN 358 - EN 813 | 15 kN
3. EN 358 | 15 kN

# BIA



## COMPLETE PROFESSIONAL HARNESS FOR FALL PROTECTION SYSTEMS

- Dorsal attachment point moved up to make wearing easier
- Front attachment point with two large fluorescent yellow rings that facilitate identification
- Gear rings made of bands
- Quick close pectoral buckle for fast and effective placement
- Work harness with new breathable ergonomic back padding for easy fitting



### CODES AND CHARACTERISTICS

CODE	standard	A [cm]	B [cm]	size	weight [g]	pcs
BIAML	CE - EN 361	72/105	50/62	M/L	900	1
BIAXL	CE - EN 361	89/130	62/80	XL	950	1

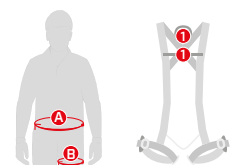

1. EN 361 | 15 kN

# HARNESSES

## METIS



### COMPLETE HARNESS FOR FALL PROTECTION SYSTEMS

- Equipped with automatic buckles on the legs for quick fitting
- Back anchor with steel ring and sternal anchor with textile webbing rings
- Equipped with two large material loops located at the sides in a rear position



#### CODES AND CHARACTERISTICS

CODE	standard	A	B	size	weight	pcs
		[cm]	[cm]		[g]	
METISML	CE - EN 361	72/105	50/62	M/L	1170	1
METISXL	CE - EN 361	89/130	62/80	XL	1220	1

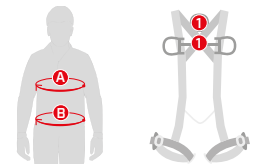

1. EN 361 | 15 kN

## METIS ANSI



### COMPLETE HARNESS FOR FALL PROTECTION SYSTEMS

- Fall arrest harness for work: light, practical and comfortable
- Equipped with load indicators to warn of falls and therefore the need to replace the product
- Equipped with two large material loops located at the sides in a rear position



#### CODES AND CHARACTERISTICS

CODE	standard	A	B	size	weight	pcs
		[cm]	[cm]		[g]	
METISANSIML	CE - EN 361 - ANSI/AXIS Z359.11-2014	72/105	50/62	M/L	1090	1
METISANSIXL	CE - EN 361 - ANSI/AXIS Z359.11-2014	89/130	62/80	XL	1130	1

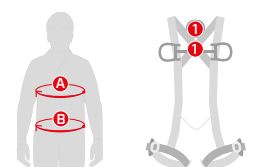

1. EN 361 | 15 kN

# HARNESSES

## IRIS



### HARNES FOR FALL PROTECTION SYSTEMS

- Lightweight, ergonomic work harness
- Back anchor with steel ring and sternal anchor with textile webbing rings
- Simple and light design and materials made it ideal for short-term uses



#### CODES AND CHARACTERISTICS

CODE	standard	size	weight [g]	pcs
IRIS	CE - EN 361	UNI	710	1

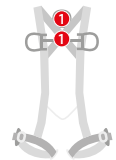

1. EN 361 | 15 kN

## APATE



### COMPLETE HARNES FOR FALL PROTECTION AND POSITIONING SYSTEMS

- Sternal and dorsal attachment points plus lateral positioning rings
- Wide waist belt guarantees good lumbar support
- The buckles ensure fast and easy adjustment



#### CODES AND CHARACTERISTICS

CODE	standard	A [cm]	B [cm]	size	weight [g]	pcs
APATEMXL	CE - EN 361 - EN 358	85/100	85/120	M/XL	1160	1

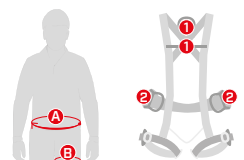

1. EN 361 | 15 kN  
2. EN 358 | 15 kN

# HARNESSES

## HERA BLACK



COMPLETE PROFESSIONAL HARNESS FOR FALL PROTECTION SYSTEMS, POSITIONING, ROPE ACCESS WORK

- Large padding on the legs for greater comfort during suspended work
- Waist bend with ergonomic shape and lighter structure, for the utmost versatility and comfort
- The upper portion is light, ergonomic and breathable, ensuring the utmost comfort in terms of wear and use



### CODES AND CHARACTERISTICS

CODE	standard	A [cm]	B [cm]	C [cm]	size	weight [g]	pcs
HERABLACKS	CE EN 361 EN 358 EN 12277/A/C EN 813	70/85	60/95	40/60	S	1100	1
HERABLACKML	CE EN 361 EN 358 EN 12277/A/C EN 813	86/110	75/110	50/70	M/L	1150	1
HERABLACKXL	CE EN 361 EN 358 EN 12277/A/C EN 813	86/110	85/130	65/78	XL	1200	1

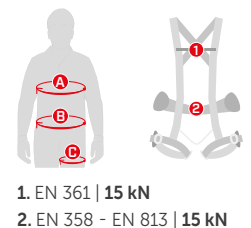

## PLANK

SEAT FOR EXTENDED SUSPENSION WORK

- Innovative seat design for prolonged suspension
- The aluminium frame can be disassembled, guaranteeing it is extremely lightweight and small for transport
- The seat, made of braided bands, adjusts perfectly to the body; this provides incredible ergonomics
- Once disassembled and placed in its bag, PLANK takes up a surprisingly small amount of space
- Perfect for use in combination with the HERA BLACK harness with RIG3 anchor multiplier and HELICON connector



### CODES AND CHARACTERISTICS

CODE	material	weight [g]	pcs
PLANK	aluminium / polyester	830	1

# SIMPLIFIES HANDLING OF GREAT ELEMENTS



Introducing WASP, the lightweight and robust anchor for lifting of prefabricated elements and CLT panels. Ideal for a multitude of on-site uses, it is certified and can be used for both axial and transverse loads.

**STRONG AS A WASP, LIGHT AS A BUTTERFLY.**



WASP is a must-have for your construction equipment!



[www.rothoblaas.com](http://www.rothoblaas.com)



**rothoblaas**

Solutions for Building Technology

# FALL PROTECTION AND POSITIONING

## DOUBLE SICUROPE

### DOUBLE ARM ROPE WITH ENERGY ABSORBER

- Complete with steel carabiner with screw ring nut and two aluminium connectors with double safety catch
- Energy absorber with activation indicator
- Protective case for energy absorber made of fabric with Velcro closure

#### CODES AND CHARACTERISTICS

CODE	standard	L [m]	weight [g]	pcs
DSIC15	CE - EN 355	1,5	890	1
DSIC2	CE - EN 355	2	930	1



CE

## SCAFFOLD DUO

### DOUBLE ARM ROPE WITH ENERGY ABSORBER

- Complete with steel carabiner with screw ring nut and two aluminium large aperture (56 mm) connectors with double safety catch included
- Energy absorber with activation indicator
- Protective case for energy absorber made of fabric with Velcro closure

#### CODES AND CHARACTERISTICS

CODE	standard	L [m]	weight [g]	pcs
SCA15	CE - EN 355	1,5	1540	1



CE

## SICUROPE

### SINGLE ARM ROPE WITH ENERGY ABSORBER

- Complete with steel carabiners with screw ring nut
- Protective case for energy absorber made of fabric with Velcro closure
- Energy absorber with activation indicator

#### CODES AND CHARACTERISTICS

CODE	standard	L [m]	weight [g]	pcs
SIC15	CE - EN 355	1,5	715	1
SIC2	CE - EN 355	2	755	1



CE

## POSITIONING

### ADJUSTABLE POSITIONING LANYARD

- Complete with steel carabiner with screw ring nut and one aluminium connector with double safety catch included
- Progressive length adjustment device for better work positioning

#### CODES AND CHARACTERISTICS

CODE	standard	L [m]	weight [g]	rope diameter [mm]	pcs
POS2	CE - EN 358	2	475	Ø10	1
POS3	CE - EN 358	3	555	Ø10	1
POS4	CE - EN 358	4	635	Ø10	1



CE

## ENERGY

### ADJUSTABLE ROPE WITH ENERGY ABSORBER

- Ø12 rope; one end has a knot to adjust the length, the other is sewn with an attachment knot
- Steel carabiner with screw ring nut and second steel large aperture (50 mm) carabiner with double safety catch

#### CODES AND CHARACTERISTICS

CODE	standard	L [m]	rope diameter [mm]	pcs
ENERGY	CE - EN 355	2	Ø12	1



CE

## PLATROPE

### ADJUSTABLE ROPE WITH ENERGY ABSORBER FOR PLATFORMS

- Complete with an autoblock steel carabiner and a large opening (56 mm) aluminium connector with double safety catch included
- Provided with BACK device that follows the worker both when ascending and descending, stopping any falls
- Protective case for energy absorber made of fabric with Velcro closure

#### CODES AND CHARACTERISTICS

CODE	standard	L [m]	weight [g]	rope diameter [mm]	pcs
PLATROPE	CE - EN 355 EN 353-2	1,9	1430	Ø11	1



CE

# ROPES AND ACCESSORIES

## LINOSTOP

CE

### GUIDED TYPE FALL ARRESTER WITH FLEXIBLE ANCHOR LINE

- Complete with two steel carabiners with screw ring nut
- Guided and sliding-type fall protection device, with fixed installation on the rope

#### CODES AND DIMENSIONS

CODE	standard	rope [mm]	L [m]	weight [g]	pcs
LINO10	CE - EN 353-2	Ø12	10	2000	1
LINO15	CE - EN 353-2	Ø12	15	2500	1
LINO20	CE - EN 353-2	Ø12	20	3000	1



## ROPE 1

CE

### SEMI-STATIC ROPE WITH SEWN ENDS AND AUTOMATIC CARABINER

- Complete with compact and ergonomic ends with rubber protectors
- Device suitable for use in combination with BACK guided type fall arrester

#### CODES AND DIMENSIONS

CODE	standard	rope [mm]	L [m]	weight [g]	pcs
ROPE110	CE - EN 354	Ø11	10	820	1
ROPE115	CE - EN 354	Ø11	15	1200	1
ROPE120	CE - EN 354	Ø11	20	1580	1
ROPE130	CE - EN 354	Ø11	30	2340	1
ROPE150	CE - EN 354	Ø11	50	3860	1



## ROPE 2

CE

### SLOTTED-HOLE ROPE

- Complete with compact and ergonomic ends with rubber protections
- Equipped with rope protection sheath

#### CODES AND DIMENSIONS

CODE	standard	rope [mm]	L [m]	weight [g]	pcs
ROPE21	CE - EN 354	Ø11	1	135	1
ROPE215	CE - EN 354	Ø11	1,5	172	1
ROPE22	CE - EN 354	Ø11	2	210	1





# EDGE

## ROPE PROTECTION

- Provided with a ring at the end that allows it to be anchored to a fixed point to keep it in position
- Use at any point on the rope thanks to the Velcro fastener
- Made of cordura, for greater strength and reduced weight



### CODES AND DIMENSIONS

CODE	material	L [mm]	weight [g]	pcs
EDGE	cordura	700	95	1

# EDGEPRO

## LIGHT ALUMINIUM ALLOY ROLLER FOR ROPE MOVEMENT

- Made of aluminium alloy for optimal weight
- Modular device with 5 articulated elements allowing adaptation to all types of terrain
- Provided with double nylon rollers that allow two ropes to move independently, even in different directions

### CODES AND DIMENSIONS

CODE	material	weight [g]	pcs
EDGEPRO	aluminium / nylon alloy	1650	1



# ROPES AND ACCESSORIES

## ROPE105

STATIC THERMOTREATED POLYAMIDE ROPE WITH OUTER SHEATH Ø10,5 mm

- Static rope with a smooth sheath structure for improved abrasion resistance, easy intensive use and good handling



### CODES AND DIMENSIONS

CODE	standard	L [m]	material	colour	weight [g/m]	strength [kN]	number of falls	elongation [%]	knottability
ROPE10560W	CE - EN 1891	60	PA	○	65,0	32	12	3,4	0,7
ROPE10570W	CE - EN 1891	70	PA	○	65,0	32	12	3,4	0,7
ROPE10580W	CE - EN 1891	80	PA	○	65,0	32	12	3,4	0,7
ROPE10590W	CE - EN 1891	90	PA	○	65,0	32	12	3,4	0,7
ROPE105100W	CE - EN 1891	100	PA	○	65,0	32	12	3,4	0,7
ROPE10560B	CE - EN 1891	60	PA	●	65,0	32	12	3,4	0,7
ROPE10570B	CE - EN 1891	70	PA	●	65,0	32	12	3,4	0,7
ROPE10580B	CE - EN 1891	80	PA	●	65,0	32	12	3,4	0,7
ROPE10590B	CE - EN 1891	90	PA	●	65,0	32	12	3,4	0,7
ROPE105100B	CE - EN 1891	100	PA	●	65,0	32	12	3,4	0,7
ROPE10560R	CE - EN 1891	60	PA	●	65,0	32	12	3,4	0,7
ROPE10570R	CE - EN 1891	70	PA	●	65,0	32	12	3,4	0,7
ROPE10580R	CE - EN 1891	80	PA	●	65,0	32	12	3,4	0,7
ROPE10590R	CE - EN 1891	90	PA	●	65,0	32	12	3,4	0,7
ROPE105100R	CE - EN 1891	100	PA	●	65,0	32	12	3,4	0,7

## ROPE11

STATIC THERMOTREATED POLYAMIDE ROPE WITH OUTER SHEATH Ø11 mm

- Static rope with a smooth sheath structure for improved abrasion resistance, easy intensive use and good handling



### CODES AND DIMENSIONS

CODE	standard	L [m]	material	colour	weight [g/m]	strength [kN]	number of falls	elongation [%]	knottability
ROPE1160W	CE - EN 1891	60	PA	○	77,9	37	24	3,1	0,7
ROPE1170W	CE - EN 1891	70	PA	○	77,9	37	24	3,1	0,7
ROPE1180W	CE - EN 1891	80	PA	○	77,9	37	24	3,1	0,7
ROPE1190W	CE - EN 1891	90	PA	○	77,9	37	24	3,1	0,7
ROPE11100W	CE - EN 1891	100	PA	○	77,9	37	24	3,1	0,7
ROPE1160B	CE - EN 1891	60	PA	●	77,9	37	24	3,1	0,7
ROPE1170B	CE - EN 1891	70	PA	●	77,9	37	24	3,1	0,7
ROPE1180B	CE - EN 1891	80	PA	●	77,9	37	24	3,1	0,7
ROPE1190B	CE - EN 1891	90	PA	●	77,9	37	24	3,1	0,7
ROPE11100B	CE - EN 1891	100	PA	●	77,9	37	24	3,1	0,7
ROPE1160R	CE - EN 1891	60	PA	●	77,9	37	24	3,1	0,7
ROPE1170R	CE - EN 1891	70	PA	●	77,9	37	24	3,1	0,7
ROPE1180R	CE - EN 1891	80	PA	●	77,9	37	24	3,1	0,7
ROPE1190R	CE - EN 1891	90	PA	●	77,9	37	24	3,1	0,7
ROPE11100R	CE - EN 1891	100	PA	●	77,9	37	24	3,1	0,7

# RETRACTABLE DEVICES

## FALL BLOCK



### RETRACTABLE DEVICE WITH STEEL CABLE

- Equipped with ultra-resistant ABS shell, slotted metal cable with reel and double safety lever connector with twist-proof swivel
- The 10 m version is suitable for both horizontal and vertical use
- The 15 and 20 m versions comply with CE EN 360 and ATEX II 2 G c T6 standards for the regulation of equipment intended for use in potentially explosive atmospheres



FAL10



FAL15 - FAL20

### CODES AND DIMENSIONS

CODE	standard	L [m]	weight [kg]	pcs
FAL10	CE - EN 360 - ATEX II 2 G c T6	10	4,6	1
FAL15	CE - EN 360	15	7,2	1
FAL20	CE - EN 360	20	7,7	1

## STRAP



### RETRACTABLE DEVICE

- External energy absorber with protective cover that can be opened for inspection
- Equipped with swivel top anchor point and twist-lock connector with twist-proof swivel
- Suitable for both vertical and horizontal use
- STRAP2 version can also be used in drop factor 2



STRAP2



STRAP6

### CODES AND DIMENSIONS

CODE	standard	L [m]	weight [kg]	pcs
STRAP2	CE - EN 360	2	0,9	1
STRAP6	CE - EN 360	6	2,4	1

# SELF-LOCKING DESCENDERS

## BACK

### FALL ARRESTER

- Safe and easy to operate with one hand
- It follows the operator optimally both uphill and downhill, stopping any falls
- Equipped with connector
- By pressing the button, it can also be used as a positioner or normal locking device as the device only slides upwards

### CODES AND DIMENSIONS

CODE	standard	weight [g]	rope diameter [mm]	pcs
BACK	CE - EN 353-2 - EN 12841 A/B	420	Ø10/Ø12	1
BACKANSI	CE - EN 353-2 - EN 12841 A/B ANSI/ISEA Z359.15-2014	435	Ø10/Ø12	1
BACKMAG	-	-	-	1

Also available in the EAC version.



CE

BACK



BACKANSI



BACKMAG

## ROPE BRAKE

### DESCENDER

- Simple easy to manoeuvre activation catch that guarantees more fluid and precise operation
- Allows two people to be lowered simultaneously for rescue operations
- Allows the cord to be recovered for ascent
- Use with Ø10-12 mm rope max. load 100 kg
- Use with Ø11-12 mm rope max. load 200 kg

### CODES AND DIMENSIONS

CODE	standard	weight [g]	rope diameter [mm]	pcs
ROPBRA	CE - EN 341 - EN 12841/C	480	Ø10/Ø12	1

Also available in the EAC version.



CE

# ELEVATOR



## MOVEABLE ROPE LOCK FOR ASCENT

- Excellent wear resistance and increased strength thanks to a new thermal and chemical process applied to the material
- Excellent locking ability even on rope that are particularly muddy thanks to the evacuation grooves in the cam and on the side
- Ergonomic click opening mechanism, easy to operate and protected against impact and accidental opening



ELELEF

ELERIG

### CODES AND DIMENSIONS

CODE	standard	weight [g]	version	rope diameter [mm]	pcs
ELERIG	CE - EN 567 - EN 12841/B	225	for right-hand- ed people	Ø8/Ø13	1
ELELEF	CE - EN 567 - EN 12841/B	225	for left-handed people	Ø8/Ø13	1

Also available in the EAC version.

# BELLY



## VENTRAL LOCKING DEVICE

- Excellent locking ability even on rope that are particularly muddy thanks to the evacuation grooves in the cam
- Excellent wear resistance and increased strength thanks to a new thermal and chemical process applied to the material
- Ergonomic click opening mechanism, easy to operate and protected against impact and accidental opening



### CODES AND DIMENSIONS

CODE	standard	weight [g]	rope diameter [mm]	pcs
BELLY	CE - EN 567 - EN 12841/B	150	Ø8/Ø13	1

Also available in the EAC version.

# DESCENDERS - POSITIONING

## ROPE BRAKE 2

### DESCENDERS FOR RESCUE WITH CONNECTORS

- Maximum capacity: **200 kg**
- Steel carabiners **with screw ring nut** included
- Practical bag for transport included

Evacuation and rescue device that is used together with individual fall protection equipment.

Appropriate for rescue in the case of injured or unconscious workers.



CE

### CODES AND DIMENSIONS

CODE	standard	L [m]	rope diameter [mm]	pcs
ROPBRA2	CE - EN 341/C	20	Ø11	1

## FOOT STEP

### MULTI-PURPOSE BRACKET FOR ASCENT

- Compact and lightweight adjustable multi-purpose bracket in a practical bag that can be attached to the harness
- Made with 3 mm Kevlar cord and equipped with a pedal and adjustment buckle in ultra-resistant nylon



### CODES AND DIMENSIONS

CODE	material	weight [g]	pcs
FOOTSTEP	kevlar/nylon	110	1

# EXTEND

## TELESCOPIC BAR

- Easy assembly of the EXTENSIONHEAD by screwing it on
- Locking of a particular section of the telescopic pole in any position



EXTENSIONHEAD



EXTENSIONHOOK



EXTENSIONPOLE

### CODES AND DIMENSIONS

CODE	standard	description	weight [g]	length min./max [mm]	pcs
EXTENSIONPOLE	EN 62193 - EN 60832-1	telescopic bar	3,84	2060/8076	1
EXTENSIONHEAD	-	hook for hanging	-	-	1
EXTENSIONHOOK	CE - EN 795:2012 B	work hook	0,5	-	1

# POLE

## TELESCOPIC BAR

- Telescopic bar equipped with a coupling system that keeps the connector open
- When the anchor point is reached, simply pull and the connector will automatically close as it releases



### CODES AND DIMENSIONS

CODE	material	weight [g]	length min./max. [mm]	pcs
POLE	aluminium	540	900/3500	1



# TEMPORARY ANCHOR SYSTEMS

## BAND23

RING WEBBING LOAD 23 kN

EAC CE

### CODES AND DIMENSIONS

CODE	standard	L [m]	weight [g]	Q <sub>r</sub> [kN]	colour	pcs
BAND2360	CE - EN 795/B EN 354 - EN 566	0,6	45	23	●	1
BAND2380	CE - EN 795/B EN 354 - EN 566	0,8	60	23	● ●	1
BAND23120	CE - EN 795/B EN 354 - EN 566	1,2	90	23	● ●	1
BAND23180	CE - EN 795/B EN 354 - EN 566	1,8	135	23	●	1



## BAND35

RING WEBBING LOAD 35 kN

EAC CE

### CODES AND DIMENSIONS

CODE	standard	L [m]	weight [g]	Q <sub>r</sub> [kN]	colour	pcs
BAND3560	CE - EN 795/B - EN 354	0,6	95	35	●	1
BAND3580	CE - EN 795/B - EN 354	0,8	130	35	●	1
BAND35120	CE - EN 795/B - EN 354	1,2	185	35	●	1
BAND35150	CE - EN 795/B - EN 354	1,5	230	35	●	1
BAND35180	CE - EN 795/B - EN 354	1,8	270	35	●	1



## RIG

ANCHOR MULTIPLIER

CE

- Anchor multiplier designed to organise a work space and create an easy system of multiple anchors
- Made of light aluminium alloy

### CODES AND DIMENSIONS

CODE	standard	material	n° anchor system	∧ ∨ [kN]	pcs
RIG3	CE RfU CN- B/P/11.114	aluminium alloy	3	36	1

Also available in the EAC version





# WEBAD

CE

## ADJUSTABLE WEBBING

- Adjustable 44 mm high-strength PE webbing with carbon steel anchor rings and adjustment buckle
- Use as a mobile anchor or positioning lanyard



### CODES AND DIMENSIONS

CODE	standard	L [cm]	weight [g]	Q <sub>r</sub> [kN]	pcs
WEBAD90	CE - EN 795/B - EN 354	55/90	330	22	1
WEBAD150	CE - EN 795/B - EN 354	85/150	370	22	1

# LANSTECO

CE

## LANYARD WITH STEEL CABLE CORE

- Fixed length lanyard made of 6 mm diameter (133 strands) galvanised cut-resistant steel cable covered with double polyester braid with an external diameter of 12 mm
- The double braid prevents the cable from sliding along the surface of the cable



### CODES AND DIMENSIONS

CODE	standard	L [m]	weight [g]	Q <sub>r</sub> [kN]	pcs
LANSTECO100	CE - EN 795/B - EN 354	1	295	25	1
LANSTECO160	CE - EN 795/B - EN 354	1,6	440	25	1
LANSTECO200	CE - EN 795/B - EN 354	2	540	25	1

# CONNECTORS

## CLASSIC

### OVAL CONNECTOR

- Oval connector available in aluminium and carbon steel, with a circular body that makes it ideal for use with mobile devices (pulleys, clamps, fall protection, etc.)
- Equipped with screw ring nut

#### CODES AND DIMENSIONS

CODE	standard	weight		↕	↔	pcs
		[g]	[kN]			
CLASTE	CE - EN 362/B	176	24	10	7	1
CLAALU	CE - EN 362/B - EN 12275/B - EAC	65	22	7	7	1



CLASTE



CLAALU



## OVAL

### CONNECTOR FOR CONNECTION TO FIXED POINTS

- Oval connector with wide opening. Ideal for severe conditions and for connection to structural anchor points, life lines, etc.
- ANSI certified high load connector
- Includes autoblock system.

#### CODES AND DIMENSIONS

CODE	standard	weight		↕	↔	pcs
		[g]	[kN]			
OVALSTE	CE - EN 362/M	215	40	15	1	1
OVALALU	CE - EN 362/B - EN 12275/B - EAC	79	26	9	1	1
OVALANS	CE - EN 362/M - ANSI Z359.12	220	40	20	1	1



OVALSTE



OVALALU



OVALANS



## XXL

### CONNECTOR WITH HIGH BREAKING LOAD

- Connector with wide opening and high breaking load. The "D" shape prevents the connector from rotating and allows the load to be distributed along the major axis.

#### CODES AND DIMENSIONS

CODE	standard	weight		↕	↔	pcs
		[g]	[kN]			
XXLSTE	CE - EN 362/B	240	50	13	1	1
XXLALU	CE - EN 362/B - EN 12275/B	95	30	9	1	1
XXLANS	CE - EN 362/M - ANSI Z359.12	265	50	20	1	1



XXLSTE



XXLALU



XXLANS



# HELICON

## HELICAL CONNECTOR WITH TWISTED BODY

- Special helical connector with twisted steel body
- Allows any device (descenders, ascenders, fall arrest devices, etc.) to be rotated by 90°, optimising its operating condition
- Auto Block locking ring (3 movements) in both CE and ANSI versions

### CODES AND DIMENSIONS

CODE	standard	weight [g]	<> [kN]	∧ [kN]	 [kN]	pcs
HELICON	CE - EN 362/M	215	40	10	-	1
HELICONANSI	CE-EN 362/M ANSI Z359.12	230	40	16	12	1



CE



# FAST LINK

## FAST LINKS

- Fast link in carbon steel, half-round "D" shape ①
- Oval fast link, available in stainless steel ②
- Trapezoidal fast link, available in stainless steel ③
- Oval fast link with large stainless steel opening ④



① FASTD



② FASTOVA



③ FASTTRI



④ FASTOVAL

CE

### CODES AND DIMENSIONS

CODE	standard	weight [g]	<> [kN]	∧ [kN]	pcs
FASTD	CE - EN 362/Q - EN 12275/Q - EAC	152	50	15	1
FASTOVA	CE - EN 362/Q - EN 12275/Q - UIAA - EAC	79	40	20	1
FASTOVA2	CE - EN 362/Q - EN 12275/Q - UIAA - EAC	142	60	20	1
FASTTRI	CE - EN 362/Q - EN 12275/Q - UIAA	89	40	10	1
FASTTRI2	CE - EN 362/Q - EN 12275/Q - UIAA	155	60	30	1
FASTOVAL	-	160	-	-	1
FASTOVAL2	-	260	-	-	1

# PULLEYS

## SINGLE - DOUBLE

### ALUMINIUM PULLEY WITH SINGLE - DOUBLE SHEAVE

- Aluminium pulleys with movable single and double sheave flanges and high-efficiency ball bearings (96%)
- For ropes of max. 13 mm diameter
- DOUBLE version with 2 attachment points for use with complex lifting systems

#### CODES AND DIMENSIONS

CODE	standard	body/pulley material	weight [g]	Q <sub>r</sub> [kN]	rope diameter [mm]	pcs
SINGLE	CE - EN 12278	aluminium alloy	245	30	max. Ø13	1
DOUBLE	CE - EN 12278	aluminium alloy	490	50	max. Ø13	1



SINGLE



DOUBLE

## LIFTING HELP

### PREASSEMBLED LIFTING SYSTEM

- Preassembled system that allows a load to be lifted by applying force equal to 1/5 of the load itself
- The self-blocking device impedes the load from returning to its previous position



#### CODES AND DIMENSIONS

CODE	ratio	weight [g]	rope diameter [mm]	rope length [m]	pcs
LIFTHELP	5 to 1	1820	10	15	1

# ACCESSORIES

## GLASS 1

GLASSES WITH TEMPLES WITH PANORAMIC FRAME

CE



### CODES AND DIMENSIONS

CODE	standard	pcs
GLASS1	CE - EN 166	1

## GLASS 2

GLASSES WITH TEMPLES WITH SMOKED LENSES

CE



### CODES AND DIMENSIONS

CODE	standard	pcs
GLASS2	CE - EN 166	1

## HEADPHONE

FOLDING EAR MUFFS

CE



### CODES AND DIMENSIONS

CODE	standard	SNR [dB]	pcs
HEAD	CE - EN 352-1	29	1

# ACCESSORIES

## RSBAG

### WATERPROOF BAG

- Extremely robust
- Internal document pocket



### CODES AND DIMENSIONS

CODE	weight [g]	capacity [L]	H [mm]	pcs
RSBAG	610	30	700	1

## RBBAG

### BACKPACK

- Complete with hook for lifting
- Extremely light and comfortable



### CODES AND DIMENSIONS

CODE	weight [g]	capacity [L]	H [mm]	pcs
RBBAG	390	23,6	400	1

## ECO

### POLYESTER/NITRILE PROTECTIVE GLOVES

#### CODES AND DIMENSIONS

CODE	standard	size	pcs
ECO8	CE - EN 388	8	1
ECO9	CE - EN 388	9	1
ECO10	CE - EN 388	10	1



## LATEX

### NYLON/LATEX PROTECTIVE GLOVES

#### CODES AND DIMENSIONS

CODE	standard	size	pcs
LAT8	CE - EN 388	8	1
LAT9	CE - EN 388	9	1
LAT10	CE - EN 388	10	1



## NITRAN

### NYLON-ELASTAN/NITRILE FOAM PROTECTIVE GLOVES

#### CODES AND DIMENSIONS

CODE	standard	size	pcs
NIT8	CE - EN 388	8	1
NIT9	CE - EN 388	9	1
NIT10	CE - EN 388	10	1



## NYLON

### NYLON/LATEX PROTECTIVE GLOVES

#### CODES AND DIMENSIONS

CODE	standard	size	pcs
NYL8	CE - EN 388	8	1
NYL9	CE - EN 388	9	1
NYL10	CE - EN 388	10	1



# TRIPODS AND CRANES

## TRI

MOBILE DEVICE WITH THREE FEET FOR LOWERING, LIFTING AND RECOVERY

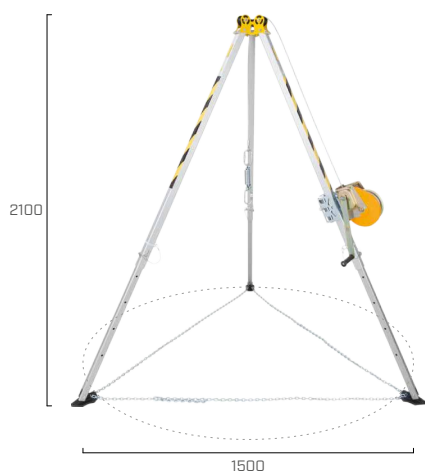

TRI2115

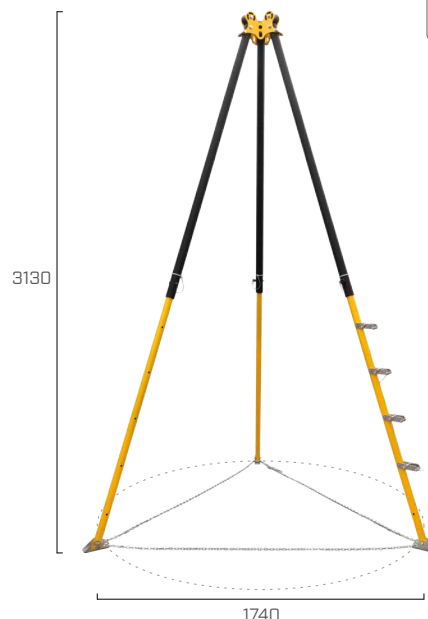

TRI3117

### CODES AND DIMENSIONS

	TRI2115	TRI3117
<b>description</b>	tripod H <sub>max</sub> = 210 cm	tripod H <sub>max</sub> = 313 cm
<b>materials</b>	colspan="2">painted aluminium/zinc plated steel/polyamide	
<b>height</b>	[cm] 153 - 210	197 - 313
<b>foot diameter</b>	[cm] 109 - 150	112 - 174
<b>space between feet</b>	[cm] 200	206
<b>weight</b>	[kg] 15,45	28,7
<b>anchor points</b>	3	3
<b>number of workers</b>	3	3
<b>transport dimensions</b>	[cm] 175 x 25 x 25	226 x 33 x 30

CODE	description	material	weight [kg]	pcs
TRIUB	universal adapter for attaching accessories	zinc-plated steel	2,25	1

CODE	description	standard	cable length [m]	cable diameter [mm]	cable type	ratio	weight [kg]	max. load capacity [kg]	pcs
TRIDAVFAL15B	adapter for retractable device TRIDAVFAL15	-	-	-	-	-	-	-	1
TRIDAVFAL15	retractable fall arrester device	EN 360; EN1496-B	15	4,8	7 x 19 + IWRC	1:8,8	11,0	140	1
TRIDAVFAL25B	adapter for retractable device TRIDAVFAL25	-	-	-	-	-	-	-	1
TRIDAVFAL25	retractable fall arrester device	EN 360; EN1496-B	25	4,8	7 x 19 + IWRC	1:7,4	15,0	140	1
TRIDAVWIN30E	automatic electric winch	-	30	6	steel	-	21	500	1
TRIDAVWIN15AC	automatic cordless winch	-	15	5	steel	-	10	140	1
TRIDAVWIN520	lifting winch	-	20	6,3	6 x 19 + NFC	1:6	13,0	140	1
TRIDAVWIN525	lifting winch	-	25	6,3	6 x 19 + NFC	1:5	14,0	140	1
TRIDAVWINU	universal winch for textile ropes	EN 1891-B	unlimited	10	textile static rope	1:40	-	-	1
TRIDAVWIN725	winch with recovery	EN 1496-B	25	6,3	6 x 19 + NFC	1:7,2	22,5	200	1
TRIDAVWIN735	winch with recovery	EN 1496-B	35	6,3	6 x 19 + NFC	1:7,2	24,5	200	1
TRIDAVWIN745	winch with recovery	EN 1496-B	45	6,3	6 x 19 + NFC	1:7,2	25,3	200	1
TRIDAVWIN750	winch with recovery	EN 1496-B	50	6,3	6 x 19 + NFC	1:7,2	26,2	200	1



## ACCESSORIES INSTALLATION DIAGRAM



## COMPATIBLE DEVICES



TRIUB

Universal adapter  
(one for each accessory to be installed)

### RETRACTABLE FALL ARREST DEVICES WITH RECOVERY FUNCTION



TRIDAVFAL15B

+



TRIDAVFAL25B

+



TRIDAVFAL15



TRIDAVFAL25

### DEVICES FOR LIFTING AND RECOVERY



TRIDAVWIN525

### DEVICES FOR LIFTING



TRIDAVWIN725



TRIDAVWINU



TRIDAVWIN30E



TRIDAVWIN15AC

# TRIPODS AND CRANES

## DAV

CRANE FOR LIFTING PEOPLE AND LOADS

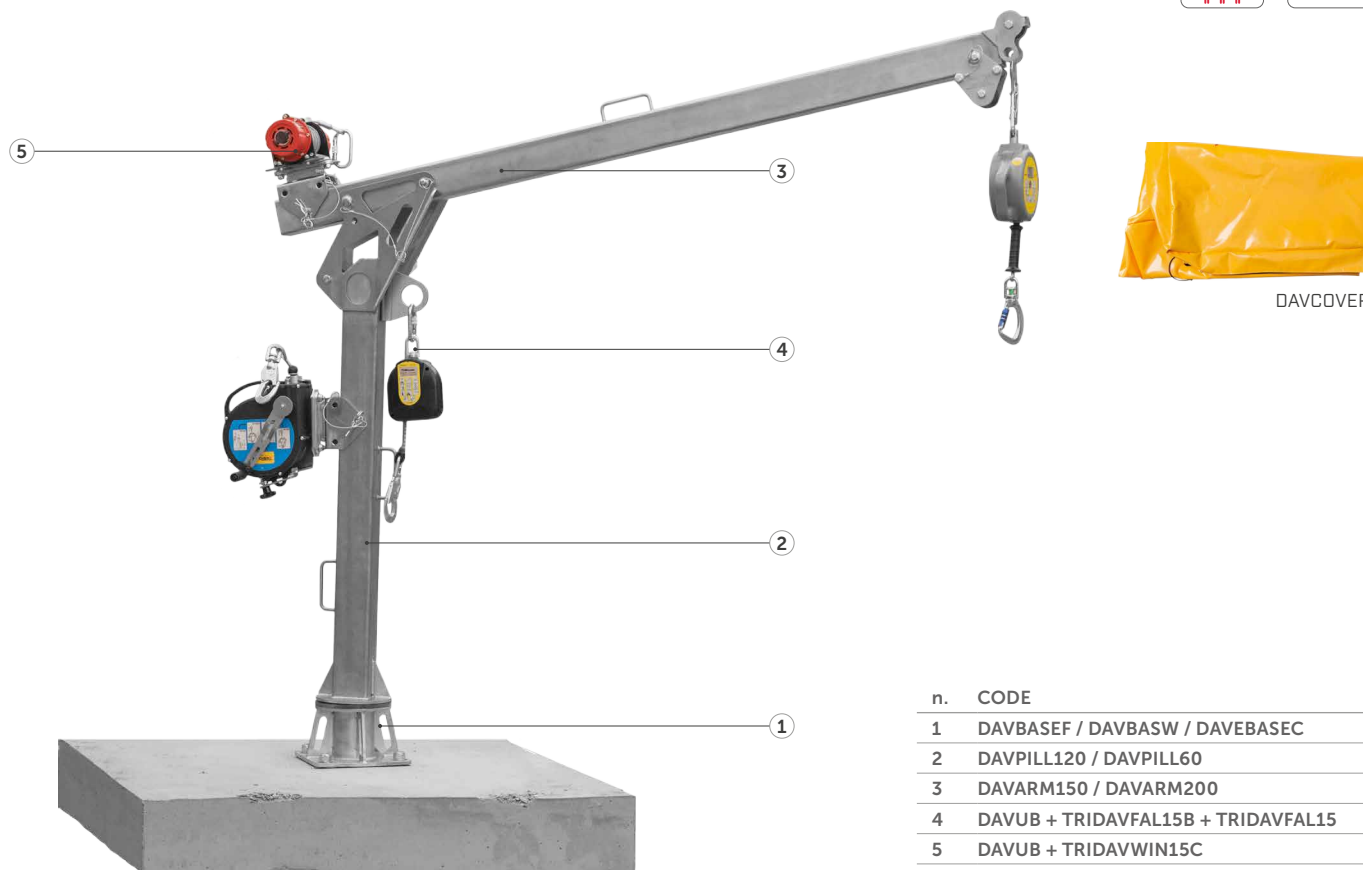

n.	CODE
1	DAVBASEF / DAVBASW / DAVEBASEC
2	DAVPILL120 / DAVPILL60
3	DAVARM150 / DAVARM200
4	DAVUB + TRIDAVFAL15B + TRIDAVFAL15
5	DAVUB + TRIDAVWIN15C

### CODES AND DIMENSIONS

CODE	description	length [cm]	height [cm]	weight [kg]	max. material load [kg]	maximum person load [kg]	no. of operators	pcs
DAVARM150	crane jib length 150 cm	150	-	20,7	500	140	3	1
DAVARM200	crane jib length 200 cm	200	-	26,7	300	100	1	1
DAVDPILL120	crane mast height 120 cm	-	120	18,06	-	-	-	1
DAVDPILL60	crane mast height 60 cm	-	60	25,5	-	-	-	1
DAVBASEW	wall support for DAV	-	21,8	11,45	-	-	-	1
DAVBASEF	floor support for DAV	-	17	10,6	-	-	-	1
DAVBASEC	support for DAV that can be attached	-	-	-	-	-	-	1
DAVCOVER	PVC cover for DAV	-	-	-	-	-	-	1
DAVUB	universal adapter for DAV accessories	-	-	-	-	-	-	1

## ACCESSORIES INSTALLATION DIAGRAM



CLASTE

STRAP2

### FLOOR SUPPORT



DAVBASEF

### WALL SUPPORT



DAVBASEW

### HOOKED HOLDER



DAVBASEC

\* See pages 203 and 210 for more details.

## COMPATIBLE DEVICES



DAVUB  
Universal adapter  
(one for each accessory to be installed)

### RETRACTABLE FALL ARREST DEVICES WITH RECOVERY FUNCTION



TRIDAVFAL15B



TRIDAVFAL25B

+

+



TRIDAVFAL15



TRIDAVFAL25

### DEVICES FOR LIFTING AND RECOVERY



TRIDAVWIN525

### DEVICES FOR LIFTING



TRIDAVWIN725



TRIDAVWINU



TRIDAVWIN30E



TRIDAVWIN15AC

\* See page 216 for more details.

# TRIPODS AND CRANES

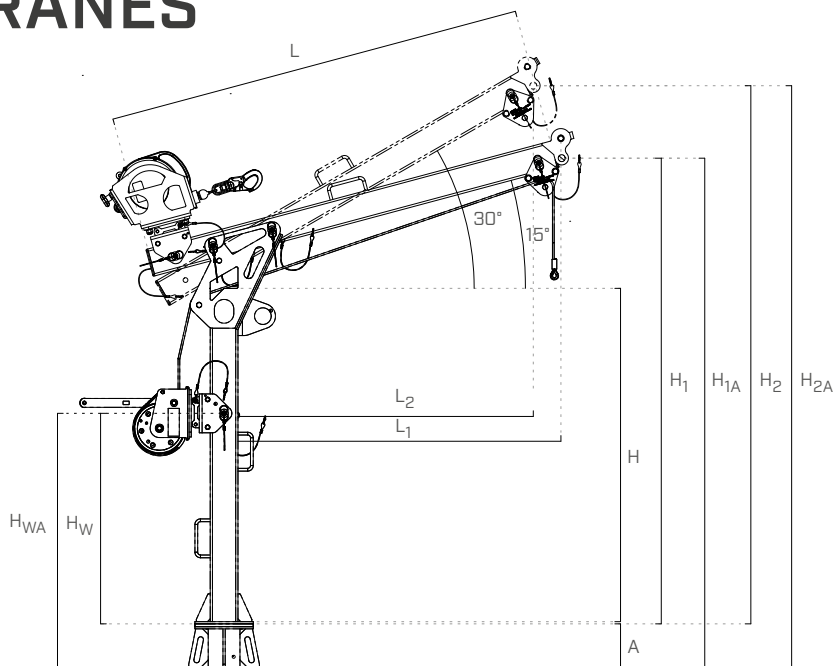

## CODES AND DIMENSIONS | DIMENSIONS OF DAV COMBINATIONS

### COMBINATION

H <sub>1A</sub>	[m]	1,3	1,42	1,9	2,02	1,25	1,38	1,85	1,98
H <sub>2A</sub>	[m]	1,56	1,81	2,16	2,41	1,51	1,76	2,11	2,36
weight	[kg]	50,22	56,21	57,66	63,65	49,43	55,42	56,87	62,86

### ARM REFERENCE

	DAVARM150	DAVARM200	DAVARM150	DAVARM200	DAVARM150	DAVARM200	DAVARM150	DAVARM200
L	[m]	1,50	2,00	1,50	2,00	1,50	2,00	2,00
weight	[kg]	20,7	26,7	20,7	26,7	20,7	26,7	26,7
L <sub>1</sub>	[m]	1,16	1,65	1,16	1,65	1,16	1,65	1,65
L <sub>2</sub>	[m]	1,06	1,50	1,06	1,50	1,06	1,50	1,50
H <sub>1</sub>	[m]	1,08	1,21	1,68	1,81	1,08	1,21	1,81
H <sub>2</sub>	[m]	1,34	1,59	1,94	2,19	1,34	1,59	2,19

### UPRIGHT REFERENCE

	DAVDPILL120	DAVDPILL60	DAVDPILL120	DAVDPILL60
H	[m]	0,6	1,2	1,2
H <sub>W</sub>	[m]	0,36	0,75	0,75
H <sub>WA</sub>	[m]	0,58	0,97	0,92
weight	[kg]	18,06	25,5	25,5

### BASES REFERENCE

	DAVBASW	DAVBASEG	
H	[m]	0,22	0,17
weight	[kg]	11,45	10,66

# STRETCHER



## ROLLABLE STRETCHER









- Rolling stretcher designed to adapt perfectly to rescue needs in complicated environments
- Increased thickness offering greater resistance to rubbing, greater protection of the rescued person, greater rigidity during handling, easy to clean and disinfect
- Suspension for vertical transport in shafts or tunnels and for horizontal winching, even from a helicopter. Easy maintenance thanks to separately replaceable components.













## CODES AND DIMENSIONS











CODE	standard	material	maximum load [kg]	transport dimensions	weight [kg]	length [cm]	width [cm]	pcs
STRETCHER	DIRECTIVE 93/42/EEC	PE - nylon	150	Ø30 x 10 cm	7,3	245	92	1

# HARNESSES | comparison

	HARNESSES			
				
	SPARTA	HESTIA	MAIA	BIA
<b>CE</b>	●	●	●	●
ANSI	-	-	-	-
<b>EN</b>	-	-	-	-
	●	●	●	●
	●	-	●	-
	●	-	●	-
<b>standard</b>	EN 361 / EN 358 EN 813 / EN 12277/A/C	EN 361	EN 361 / EN 358 EN 813	EN 361
	150	-	140	150
	1650-1750	1550-1750	1720-1820	900-950





	HARNESSES				
					
	METIS ANSI	METIS	IRIS	APATE	HERA BLACK
<b>CE</b>	●	●	●	●	●
ANSI	●	-	-	-	-
<b>EN</b>	-	●	-	-	●
	●	●	●	●	●
	-	-	-	●	●
	-	-	-	-	●
<b>standard</b>	EN 361 / ANSI Z359.11-2014	EN 361	EN 361	EN 361 EN 358	EN 361 / EN 358 EN 813 / EN 12277/A/C
	140	140	-	-	-
	1090-1130	1170-1220	710	1160	1100-1200

# CONNECTORS | comparison

	CLASSIC		OVAL		
					
	CLASTE	CLAALU	OVALSTE	OVALALU	OVALANS
<b>CE</b>	●	●	●	●	●
ANSI	-	-	-	-	●
standard	EN 362/B	EN 362/B / EN 12275/B	EN 362/M	EN 362/B / EN 12275/B	EN 362/M / ANSI Z359.12
	screw ring nut	screw ring nut	autoblock	autoblock	autoblock
material	steel	aluminium	steel	aluminium	steel
	176	65	215	79	220
	24	20	40	26	40
	-	7	15	9	20
	-	7	-	-	-

	XXL			HELICON	
					
	XXLSTE	XXLALU	XXLANS	HELICON	HELICON ANSI
<b>CE</b>	●	●	●	●	●
ANSI	-	-	●	-	●
standard	EN 362/B	EN 362/B / EN 12275/B	EN 362/M / ANSI Z359.12	EN 362/B	EN 362/M / ANSI Z359.12
	autoblock	autoblock	autoblock	autoblock	autoblock
material	steel	aluminium	steel	steel	steel
	260	95	265	215	230
	50	30	50	40	40
	-	9	20	-	16
	-	-	-	-	-

# ACCESSORIES | comparison

		GLOVES			
					
		ECO	LATEX	NITRAN	NYLON
CE symbol	<b>CE</b>	●	●	●	●
standard		EN 388	EN 388	EN 388	EN 388
resistance to mechanical risks EN 388 (max. no. of scale)	abrasion (4)	4	3	4	3
	shear (5)	1	1	1	1
	tear (4)	3	3	2	3
	perforation (4)	1	1	1	1



**COMPLEMENTARY PRODUCTS**

## COMPLEMENTARY PRODUCTS

### ACCESSORIES

---

#### TOWER PEAK

ADAPTOR FOR DOUBLE LAYER RIDGE PIECE FOR TOWER. . . . . 228

#### TOWER SLOPE

FASTENING GUIDE FOR TOWER ON RAFTER . . . . . 228

#### TOWLATEVO

TOWER FOR INSTALLATION ON VERTICAL STRUCTURES . . . . . 229

#### TOPLATE

COUNTERPLATE FOR TOWER. . . . . 229

#### TOPLATE 2.0

COUNTERPLATE FOR TOWER XL . . . . . 230

#### TRAPO

SUPPORT FOR TOWER XL ON TRAPEZOIDAL  
STEEL DECK ROOFS . . . . . 230

#### BEF . . . . . 231

#### MANICA ROLL

SELF-ADHESIVE LEAD AND BUTYL VERSION. . . . . 232

#### MANICA LEAD

LEAD PROFILE WITH EPDM SLEEVE . . . . . 232

#### MANICA POST

ADHESIVE SEALING SLEEVE FOR OUTDOORS . . . . . 232

### FASTENERS

---

#### HBS

COUNTERSUNK SCREW. . . . . 234

#### VGS

FULL THREAD CONNECTOR WITH  
COUNTERSUNK HEAD . . . . . 235

#### TBS

FLANGE HEAD SCREW . . . . . 235

#### TBS EVO

FLANGE HEAD SCREW . . . . . 236

#### WBAZ

STAINLESS STEEL WASHER WITH SEALING GASKET. . . . . 236

#### MTS A2 | AISI304

SCREWS FOR SHEET METAL . . . . . 236

#### MCS A2 | AISI304

SCREW WITH WASHER FOR SHEET METAL . . . . . 237

#### SKR | SKS

SCREW ANCHOR FOR CONCRETE . . . . . 238

#### SKR-E | SKS-E

SCREW ANCHOR FOR CONCRETE CE1 . . . . . 239

#### EKS

HEXAGONAL HEAD BOLT  
STEEL CLASS 8.8 - ZINC PLATED . . . . . 239

<b>ABS</b>	
HEAVY-DUTY EXPANSION ANCHOR WITH CLAMP CE1	240
<b>AB1</b>	
HEAVY DUTY EXPANSION ANCHOR CE1	240
<b>AB1 A4</b>	
CE1 STAINLESS STEEL HEAVY-DUTY EXPANSION ANCHOR	241
<b>AB7</b>	
HEAVY DUTY EXPANSION ANCHOR CE7	241
<b>VIN-FIX</b>	
VINYL ESTER CHEMICAL ANCHOR WITHOUT STYRENE	242
<b>VIN-FIX PRO</b>	
VINYL ESTER CHEMICAL ANCHOR WITHOUT STYRENE	242
<b>HYB-FIX</b>	
HIGH-PERFORMANCE HYBRID CHEMICAL ANCHOR	242
<b>EPO-FIX PLUS</b>	
HIGH-PERFORMANCE EPOXY CHEMICAL ANCHOR	243
<b>INA</b>	
5.8 STEEL CLASS THREADED ROD FOR CHEMICAL ANCHORS	243
<b>IHP - IHM</b>	
BUSHINGS FOR PERFORATED MATERIALS	243
<b>ULS AI 9021</b>	
WASHER	244
<b>MUT AI 934</b>	
HEXAGONAL NUT	244
<b>MUT AI 985</b>	
SELF-LOCKING NUT	244
<b>MUT AI 1587</b>	
BLIND NUT	244
<b>MGS 1000</b>	
THREADED ROD	245
<b>MGS 1000</b>	
THREADED ROD	245
<b>MUT 934</b>	
HEXAGONAL NUT	245
<b>ULS 9021</b>	
WASHER	246
<b>ULS 440</b>	
WASHER	246
<b>ULS 1052</b>	
WASHER	246
<b>ULS 125</b>	
WASHER	246
<b>CRICKET</b>	
8 SIZES RATCHETING WRENCH	248

## TOOLS

<b>BEAR</b>	
TORQUE WRENCH	248
<b>FINCH</b>	
PROFESSIONAL RIVETING MACHINE	248
<b>BIRD</b>	
BATTERY-OPERATED RIVETING MACHINE	249
<b>ROPE CLAMP</b>	
CABLE TENSIONER FOR ANCHOR LINE	249
<b>CABLE CLAMP</b>	
STEEL ROPE CLAMP	249
<b>CABCUT</b>	
SHEARS	250
<b>A 10 M</b>	
CORDLESS SCREWDRIVER 10,8 V	250
<b>ASB 18 M BL</b>	
CORDLESS PERCUSSION DRILL	250
<b>SOCKET</b>	
BUSHINGS AND BITS	251
<b>SNAIL METAL</b>	
HSS HIGH-SPEED STEEL TWIST DRILL BIT	251
<b>TORLIM</b>	
TORQUE LIMITER	252
<b>TUCA</b>	
RAPID FEED PIPE CUTTER 6-67 mm	252
<b>FLY</b>	
PROFESSIONAL GUN FOR 310 mL CARTRIDGES	252
<b>MAMMOTH</b>	
SPECIAL GUN FOR 400 mL CARTRIDGES	253
<b>MAMAUTO600</b>	
BATTERY-OPERATED RESIN GUN	253
<b>ESTRO</b>	
25 KN PORTABLE EXTRACTOMETER	253
<b>DISTY</b>	
LASER DISTANCE METER	254
<b>SNAIL</b>	
MEASURING TAPE	254
<b>MANTA</b>	
TAPE WHEEL, STEEL	254
<b>RBMET</b>	
FOLDING RULER	255
<b>SNAIL PULSE</b>	
CARBIDE DRILL BIT IN HM WITH SDS DRILL CHUCK SHANK	255

# TOWER PEAK

## ADAPTOR FOR DOUBLE LAYER RIDGE PIECE FOR TOWER



- Accessory that allows for anchor line assembly even on a closed roof package, without the need for opening and adapting to any slope
- The TOWER PEAK adaptor makes it possible to provide safety for up to four workers



### CODES AND DIMENSIONS

CODE	material	B	H	L	pcs
		[mm]	[mm]	[mm]	
TOWERPEAK	S235JR zinc plated steel	100	30	350	1

### COMPLEMENTARY PRODUCTS

n.	CODE	description	Ø	min. dimensions GL24h beam
			[mm]	[mm]
24	HBS	screw for timber	8	100 x 100

The values indicated are the result of experimental tests carried out under the supervision of third parties in accordance with the standard referred to. For a calculation report with minimum distances according to the relevant standard requirements, the substructure must be checked by a qualified engineer before installation.

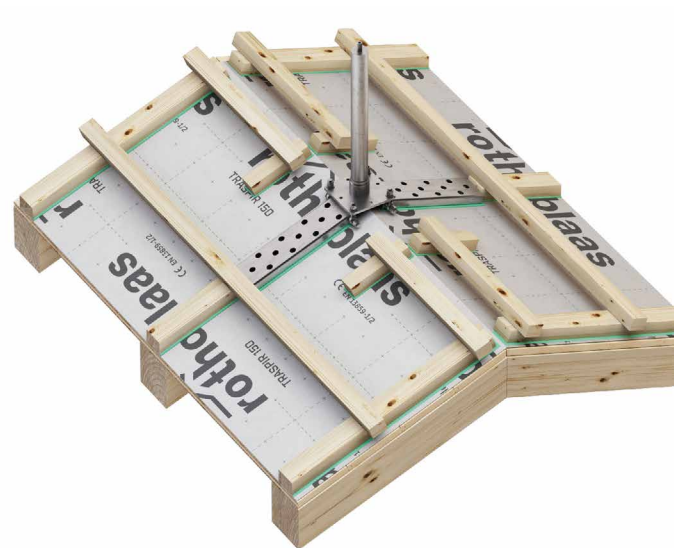

# TOWER SLOPE

## FASTENING GUIDE FOR TOWER ON RAFTER



- It can be positioned at any point on the roof
- Due to the range of action from 50 to 100 cm, it can cover the most common distances between beams



### CODES AND DIMENSIONS

CODE	material	B	H	L	pcs
		[mm]	[mm]	[mm]	
TOWERSLOPE	S235JR zinc plated steel	100	20	1200	1

### COMPLEMENTARY PRODUCTS

n.	CODE	description	Ø	min. dimensions GL24h beam
			[mm]	[mm]
16	HBS	screw for timber	8	100 x 100

The values indicated are the result of experimental tests carried out under the supervision of third parties in accordance with the standard referred to. For a calculation report with minimum distances according to the relevant standard requirements, the substructure must be checked by a qualified engineer before installation.



# TOWLATEVO

## TOWER FOR INSTALLATION ON VERTICAL STRUCTURES

- It allows the construction of lifelines on a TOWER support, also mounted on a vertical structure
- It supports all the required forces for an anchor line, based on EN 795:2012 C



### CODES AND DIMENSIONS

CODE	material	weight	B	H	L	pcs
		[kg]	[mm]	[mm]	[mm]	
TOWLATEVO	S235JR zinc plated steel	3,5	186	208	182	1

# TOPLATE

## COUNTERPLATE FOR TOWER

- Counterplate for TOWER and TOWER22 complete with nuts and washers



### CODES AND DIMENSIONS

CODE	material	B	H	L	pcs
		[mm]	[mm]	[mm]	
TOPLATE	S235JR zinc plated steel	150	8	150	1

### COMPLEMENTARY PRODUCTS

n.	CODE	description	Ø
			[mm]
4	MGS	threaded rod	12

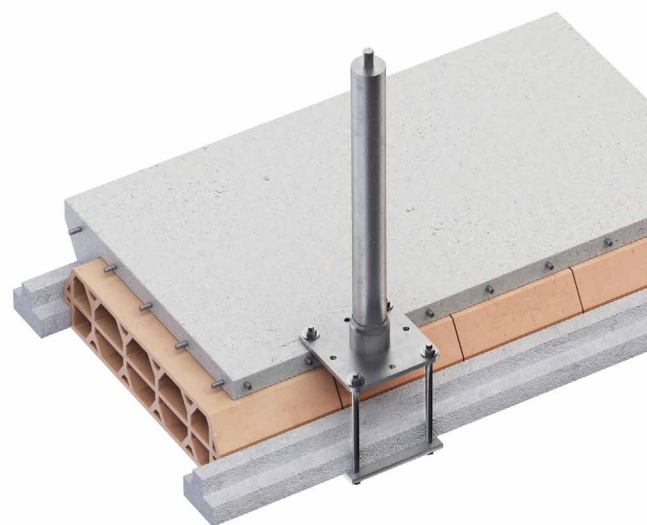

The values indicated are the result of experimental tests carried out under the supervision of third parties in accordance with the standard referred to. For a calculation report with minimum distances according to the relevant standard requirements, the substructure must be checked by a qualified engineer before installation.

# TOPLATE 2.0

## COUNTERPLATE FOR TOWER



- Counter plate for TOWER

### CODES AND DIMENSIONS

CODE	material	H	L	B	pcs
		[mm]	[mm]	[mm]	
TOPLATE2	S235JR zinc plated steel	8	350	350	1

### COMPLEMENTARY PRODUCTS

n.	CODE	description	Ø
			[mm]
4	MGS	threaded rod	12

The values indicated are the result of experimental tests carried out under the supervision of third parties in accordance with the standard referred to. For a calculation report with minimum distances according to the relevant standard requirements, the substructure must be checked by a qualified engineer before installation.

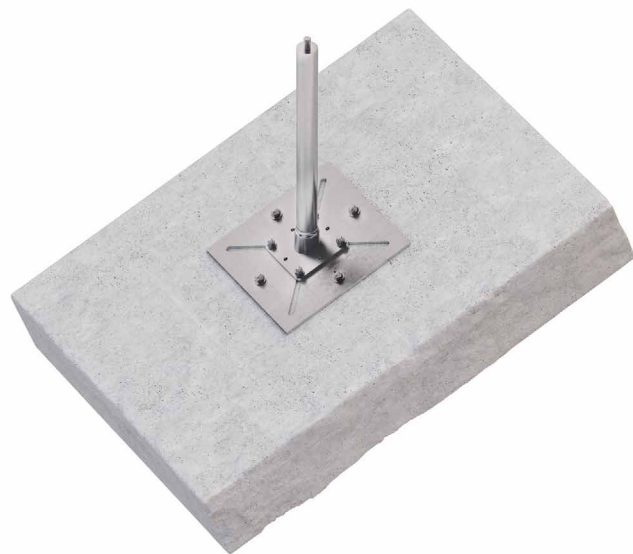

# TRAPO

## SUPPORT FOR TOWER XL ON TRAPEZOIDAL STEEL DECK ROOFS

- It can be assembled on trapezoidal steel decks min. thickness 0.75 mm with or without insulation layer (including fastening screws)

### CODES AND DIMENSIONS

CODE	material	range [mm]	pcs
TRAPO	S235JR zinc plated steel	520 - 660	1

The values indicated are the result of experimental tests carried out under the supervision of third parties in accordance with the standard referred to. For a calculation report with minimum distances according to the relevant standard requirements, the substructure must be checked by a qualified engineer before installation.



# PALMIFIX

## UNIVERSAL COUNTERPLATE FOR HOOK, LOOP AND AOS

### CODES AND DIMENSIONS

CODE	material	B [mm]	L [mm]	H [mm]	s [mm]	pcs
PALMIFIX	S235JR zinc plated steel	350	130	-	6	1
OMEGA	S235JR zinc plated steel	290	80	68	8	1

### COMPLEMENTARY PRODUCTS

CODE	description	Ø	pcs
		[mm]	
MGS	threaded rod	M16	1
ULS - MUT	washer - nut	M16	1



PALMIFIX



OMEGA

## BEF TOWERXL1 : TOWER XL FASTENING SET FOR AERATED CEMENT

CODE	n.	content	Ø [mm]	pcs
BEFTOWERXL1	8	hexagonal head bolt	M10	1
	8	heavy anchors	M10	
	8	washer	-	



## BEF PALMI: LOOP FASTENING SET FOR PALMIFIX

CODE	n.	content	Ø [mm]	L [mm]	pcs
BEFPALMI	2	countersunk head bolts	8	30	1
	2	M8 self-locking nut	-	-	



## BEFSLIM: FASTENING SET FOR SLIM

CODE	n.	content	Ø [mm]	pcs
BEFSLIM1	2	washer	M10	1
	2	hexagonal nut	M10	
	1	threaded rod (L = 200 mm)	M10	
	1	self-locking nut	M10	
	1	GEKA (DEXT = 50 mm)	-	
BEFSLIM2	3	washer	M10	1
	2	hexagonal nut	M10	
	1	washer	M12	
	1	threaded rod (L = 200 mm)	M10	
	2	self-blocking nut	M10	
	1	round head bolt	M10	
1	"L" plate	-		
1	GEKA (DEXT = 50 mm)	-		



BEFSLIM1



BEFSLIM2

## BEFTOWER: FASTENING SET FOR TOWER

CODE	n.	content	Ø [mm]	L [mm]	pcs
BEF201VGS	8	VGS screws	9	160	1
	4	washer	-	-	
BEF202VGS	8	VGS screws	9	200	1
	4	washer	-	-	



## BEFPLATE: TOWER - TOWER22 FASTENING SET FOR TOPLATE 2.0

CODE	n.	content	Ø [mm]	pcs
BEFPLATE	4	self-blocking nut	M12	1
	4	hexagonal head bolts 35 mm	M12	
	4	washer	-	

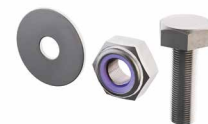

## BEF KITE: FASTENING SET FOR KITE

CODE	n.	content	d <sub>1</sub> [mm]	L [mm]	pcs
BEFKITE	1	VGS screw	11	100	1
	2	HBS screws	8	100	



# MANICA ROLL

SELF-ADHESIVE LEAD AND BUTYL VERSION

## CODES AND DIMENSIONS

CODE	B [mm]	s [mm]	L [m]	colour	RAL	pcs
MANROLL1	300	1,5	5	brick red	8004	1
MANROLL2	300	1,5	5	brown	8017	1
MANROLL3	300	1,5	5	dark brown	8019	1
MANROLL4	300	1,5	5	black	9005	1
MANROLL5	300	1,5	5	graphite	7016	1

Avoid contact with skin, eyes and food. Do not breathe dust.



# MANICA LEAD

LEAD PROFILE WITH EPDM SLEEVE

## CODES AND DIMENSIONS

CODE	s [mm]	B [mm]	L [mm]	Ø [mm]	material	pcs
MANEPDM	-	-	-	48	EPDM	1
MANLEAD	1	310	405	-	lead <sup>(1)</sup>	1

<sup>(1)</sup>Avoid contact with skin, eyes and food. Do not breathe dust. Waste classification (2014/955/EU): 17 09 04



# MANICA POST

ADHESIVE SEALING SLEEVE FOR OUTDOORS

## CODES AND DIMENSIONS

CODE	B [mm]	H [mm]	Ø [mm]	colour	pcs
MANPOST1	300	200	25 / 32	brown	5
MANPOST2	300	200	42 / 55	brown	5
MANPOST3	230	230	42 / 55	aluminium	4

Waste classification (2014/955/EU): 17 09 04.





# PROFESSIONAL SEALING FOR EXCEPTIONAL DURABILITY



The products contained in the "Tapes, sealants and membranes" catalogue are a concentrate of technology and benefits for your projects! Solutions designed to suit every climate zone in the world and every building system, new systems to ensure more durability to the ground connection, products to simplify the window/door sealing, new certified chemicals for reaction to fire and detailed information on the environmental aspects of our products, from production to disposal.

Build a better world with us, download the catalogue from our website now.



[www.rothoblaas.com](http://www.rothoblaas.com)



**rothoblaas**

Solutions for Building Technology

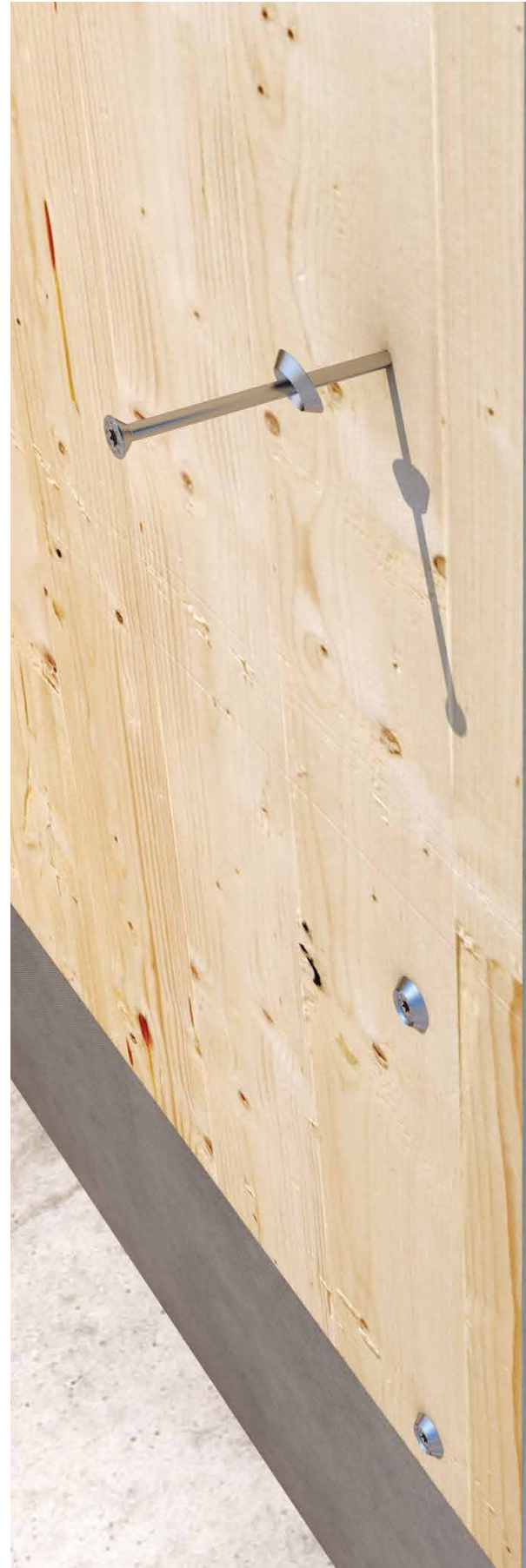

### CODES AND DIMENSIONS

d <sub>1</sub> [mm]	CODE	L [mm]	b [mm]	A [mm]	pcs
8 TX 40	HBS880	80	52	28	100
	HBS8100	100	52	48	100
	HBS8120	120	60	60	100
	HBS8140	140	60	80	100
	HBS8160	160	80	80	100
	HBS8180	180	80	100	100
	HBS8200	200	80	120	100
	HBS8220	220	80	140	100
	HBS8240	240	80	160	100
	HBS8260	260	80	180	100
	HBS8280	280	80	200	100
	HBS8300	300	100	200	100
	HBS8320	320	100	220	100
	HBS8340	340	100	240	100
	HBS8360	360	100	260	100
	HBS8380	380	100	280	100
	HBS8400	400	100	300	100
	HBS8440	440	100	340	100
	HBS8480	480	100	380	100
	HBS8520	520	100	420	100
10 TX 40	HBS1080	80	52	28	50
	HBS10100	100	52	48	50
	HBS10120	120	60	60	50
	HBS10140	140	60	80	50
	HBS10160	160	80	80	50
	HBS10180	180	80	100	50
	HBS10200	200	80	120	50
	HBS10220	220	80	140	50
	HBS10240	240	80	160	50
	HBS10260	260	80	180	50
	HBS10280	280	80	200	50
	HBS10300	300	100	200	50
	HBS10320	320	100	220	50
	HBS10340	340	100	240	50
	HBS10360	360	100	260	50
	HBS10380	380	100	280	50
HBS10400	400	100	300	50	

# VGS



## FULL THREAD CONNECTOR WITH COUNTERSUNK HEAD

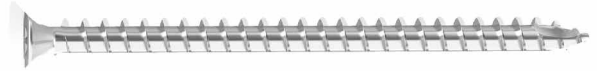

### CODES AND DIMENSIONS

d <sub>1</sub> [mm]	CODE	L [mm]	b [mm]	pcs
9 TX 40	VGS9100	100	90	25
	VGS9120	120	110	25
	VGS9140	140	130	25
	VGS9160	160	150	25
	VGS9180	180	170	25
	VGS9200	200	190	25
	VGS9220	220	210	25
	VGS9240	240	230	25
	VGS9260	260	250	25
	VGS9280	280	270	25
	VGS9300	300	290	25
	VGS9320	320	310	25
	VGS9340	340	330	25
	VGS9360	360	350	25
	VGS9380	380	370	25
	VGS9400	400	390	25
	VGS9440	440	430	25
	VGS9480	480	470	25
	VGS9520	520	510	25

d <sub>1</sub> [mm]	CODE	L [mm]	b [mm]	pcs	
11 TX 50	VGS11100	100	90	25	
	VGS11125	125	115	25	
	VGS11150	150	140	25	
	VGS11175	175	165	25	
	VGS11200	200	190	25	
	VGS11225	225	215	25	
	VGS11250	250	240	25	
	VGS11275	275	265	25	
	VGS11300	300	290	25	
	VGS11325	325	315	25	
	VGS11350	350	340	25	
	VGS11375	375	365	25	
	VGS11400	400	390	25	
	VGS11450	450	440	25	
	VGS11500	500	490	25	
	VGS11550	550	540	25	
	VGS11600	600	590	25	
	13 TX 50	VGS13100	100	90	25
		VGS13150	150	140	25
		VGS13200	200	190	25
VGS13300		300	280	25	
VGS13400		400	380	25	
VGS13500		500	480	25	
VGS13600	600	580	25		

# TBS

## FLANGE HEAD SCREW



### CODES AND DIMENSIONS

d <sub>1</sub> [mm]	d <sub>K</sub> [mm]	CODE	L [mm]	b [mm]	A [mm]	pcs
8 TX 40	19	TBS840	40	32	8	100
		TBS860	60	52	10	100
		TBS880	80	52	28	50
		TBS8100	100	52	48	50
		TBS8120	120	80	40	50
		TBS8140	140	80	60	50
		TBS8160	160	100	60	50
		TBS8180	180	100	80	50
		TBS8200	200	100	100	50
		TBS8220	220	100	120	50
		TBS8240	240	100	140	50
		TBS8260	260	100	160	50
		TBS8280	280	100	180	50
		TBS8300	300	100	200	50
		TBS8320	320	100	220	50
		TBS8340	340	100	240	50
		TBS8360	360	100	260	50
		TBS8380	380	100	280	50
		TBS8400	400	100	300	50
		TBS8440	440	100	340	50
		TBS8480	480	100	380	50
		TBS8520	520	100	420	50

d <sub>1</sub> [mm]	d <sub>K</sub> [mm]	CODE	L [mm]	b [mm]	A [mm]	pcs
10 TX 50	25	TBS10100	100	52	48	50
		TBS10120	120	60	60	50
		TBS10140	140	60	80	50
		TBS10160	160	80	80	50
		TBS10180	180	80	100	50
		TBS10200	200	100	100	50
		TBS10220	220	100	120	50
		TBS10240	240	100	140	50
		TBS10260	260	100	160	50
		TBS10280	280	100	180	50
		TBS10300	300	100	200	50
		TBS10320	320	120	200	50
		TBS10340	340	120	220	50
		TBS10360	360	120	240	50
		TBS10380	380	120	260	50
		TBS10400	400	120	280	50
		TBS10440	440	120	320	50
		TBS10480	480	120	360	50
		TBS10520	520	120	400	50

# TBS EVO

## FLANGE HEAD SCREW



### CODES AND DIMENSIONS

d <sub>1</sub> [mm]	CODE	L [mm]	b [mm]	A [mm]	pcs
6 TX 30	TBSEVO660	60	40	20	100
	TBSEVO680	80	50	30	100
	TBSEVO6100	100	60	40	100
	TBSEVO6120	120	75	45	100
	TBSEVO6140	140	75	65	100
	TBSEVO6160	160	75	85	100
	TBSEVO6180	180 <td 75	105	100	
	TBSEVO6200	200	75	125	100

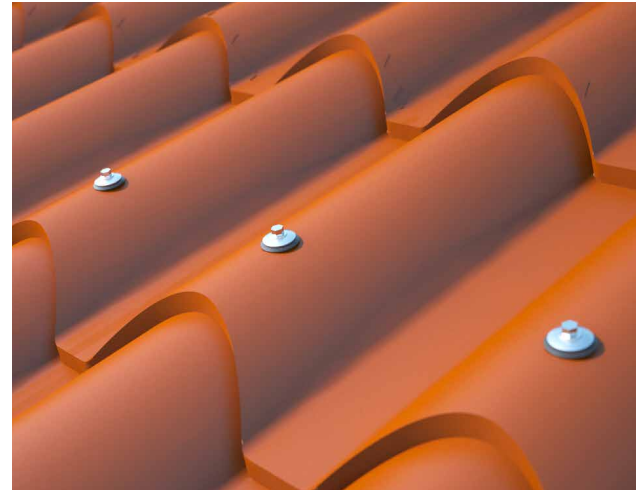

# WBAZ

## STAINLESS STEEL WASHER WITH SEALING GASKET



### CODES AND DIMENSIONS

CODE	screw [mm]	D <sub>2</sub> [mm]	H [mm]	D <sub>1</sub> [mm]	pcs
WBAZ25A2	6,0 - 6,5	25	15	6,5	100

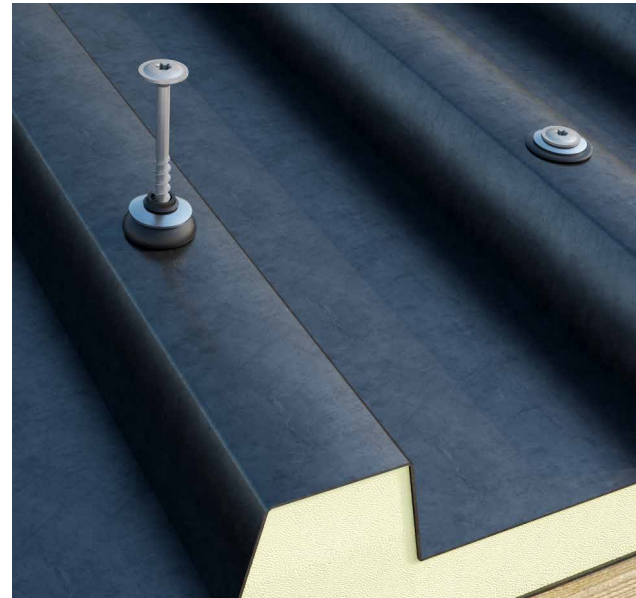

# MTS A2 | AISI304

## SCREWS FOR SHEET METAL



### CODES AND DIMENSIONS

d <sub>1</sub> [mm]	CODE	SW	d <sub>UK</sub> [mm]	L [mm]	b [mm]	A [mm]	pcs
6 SW 8	MTS680	SW 8	12,5	80	58	20÷40	100
	MTS6100	SW 8	12,5	100	58	40÷60	100
	MTS6120	SW 8	12,5	120	58	60÷80	100



# MCS A2 | AISI304

A2  
AISI 304

## SCREW WITH WASHER FOR SHEET METAL

### CODES AND DIMENSIONS

MCS A2: stainless steel

d <sub>1</sub> [mm]	CODE	L [mm]	pcs
4,5 TX 20	MCS4525A2	25	200
	MCS4535A2	35	200
	MCS4545A2	45	200
	MCS4560A2	60	200
	MCS4580A2	80	200
	MCS45100A2	100	200
	MCS45120A2	120	200

MCS M: RAL 8017 - chocolate brown

d <sub>1</sub> [mm]	CODE	L [mm]	pcs
4,5 TX 20	MCS4525A2M	25	200
	MCS4535A2M	35	200
	MCS4545A2M	45	200

MCS CU: copper finish

d <sub>1</sub> [mm]	CODE	L [mm]	pcs
4,5 TX 20	MCS4525CU	25	200
	MCS4535CU	35	200
	MCS4545CU	45	200
	MCS4560CU	60	200
	MCS4580CU	80	200
	MCS45100CU	100	100
	MCS45120CU	120	200

MCS B: RAL 9002 - light grey

d <sub>1</sub> [mm]	CODE	L [mm]	pcs
4,5 TX 20	MCS4525A2B	25	200
	MCS4535A2B	35	200
	MCS4545A2B	45	200

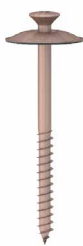
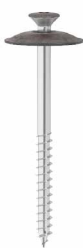

# SKR | SKS

## SCREW ANCHOR FOR CONCRETE

- $d_1$  external diameter of anchor
- $L$  anchor length
- $t_{fix}$  maximum fastening thickness
- $h_1$  minimum hole depth
- $h_{nom}$  nominal anchoring depth
- $d_0$  hole diameter in the concrete support
- $d_f$  maximum hole diameter in the element to be fastened
- $SW$  wrench size SKR
- $d_k$  SKS head diameter
- $T_{inst}$  tightening torque

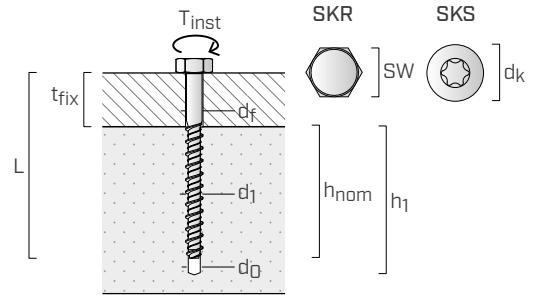

## CODES AND DIMENSIONS

### SKR hexagonal head

CODE	$d_1$ [mm]	$L$ [mm]	$t_{fix}$ [mm]	$h_{1,min}$ [mm]	$h_{nom}$ [mm]	$d_0$ [mm]	$d_{f,timber}$ [mm]	$d_{f,steel}$ [mm]	$SW$ [mm]	$T_{inst}$ [Nm]	pcs
SKR7560	7,5	60	10	60	50	6	8	8-10	13	15	50
SKR7580		80	30	60	50	6	8	8-10	13	15	50
SKR75100		100	20	90	80	6	8	8-10	13	15	50
SKR1080	10	80	30	65	50	8	10	10-12	16	25	50
SKR10100		100	20	95	80	8	10	10-12	16	25	25
SKR10120		120	40	95	80	8	10	10-12	16	25	25
SKR10140		140	60	95	80	8	10	10-12	16	25	25
SKR10160	12	160	80	95	80	8	10	10-12	16	25	25
SKR12100		100	20	100	80	10	12	12-14	18	50	25
SKR12120		120	40	100	80	10	12	12-14	18	50	25
SKR12140		140	60	100	80	10	12	12-14	18	50	25
SKR12160		160	80	100	80	10	12	12-14	18	50	25
SKR12200		200	120	100	80	10	12	12-14	18	50	25
SKR12240		240	160	100	80	10	12	12-14	18	50	25
SKR12280		280	200	100	80	10	12	12-14	18	50	25
SKR12320	320	240	100	80	10	12	12-14	18	50	25	
SKR12400	400	320	100	80	10	12	12-14	18	50	25	

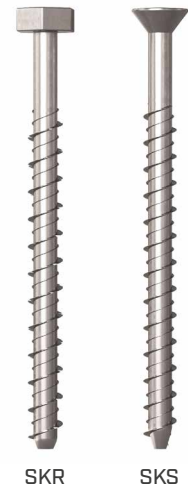

### SKS countersunk head

CODE	$d_1$ [mm]	$L$ [mm]	$t_{fix}$ [mm]	$h_{1,min}$ [mm]	$h_{nom}$ [mm]	$d_0$ [mm]	$d_{f,timber}$ [mm]	$d_k$ [mm]	TX	$T_{inst}$ [Nm]	pcs
SKS7560	7,5	60	10	60	50	6	8	13	TX40	-	50
SKS7580		80	30	60	50	6	8	13	TX40	-	50
SKS75100		100	20	90	80	6	8	13	TX40	-	50
SKS75120		120	40	90	80	6	8	13	TX40	-	50
SKS75140		140	60	90	80	6	8	13	TX40	-	50
SKS75160		160	80	90	80	6	8	13	TX40	-	50

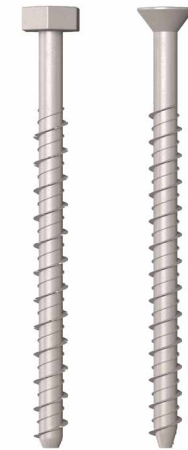

### SKR EVO hexagonal head

CODE	$d_1$ [mm]	$L$ [mm]	$t_{fix}$ [mm]	$h_{1,min}$ [mm]	$h_{nom}$ [mm]	$d_0$ [mm]	$d_{f,timber}$ [mm]	$d_{f,steel}$ [mm]	$SW$ [mm]	$T_{inst}$ [Nm]	pcs
SKREVO7560	7,5	60	10	60	50	6	8	8-10	13	15	50
SKREVO1080	10	80	30	65	50	8	10	10-12	16	25	50
SKREVO12100	12	100	20	100	80	10	12	12-14	18	50	25



### SKS EVO countersunk head

CODE	$d_1$ [mm]	$L$ [mm]	$t_{fix}$ [mm]	$h_{1,min}$ [mm]	$h_{nom}$ [mm]	$d_0$ [mm]	$d_{f,timber}$ [mm]	$d_k$ [mm]	TX	$T_{inst}$ [Nm]	pcs
SKSEVO7580	7,5	80	30	60	50	6	8	13	TX40	-	50
SKSEVO75100		100	20	90	80	6	8	13	TX40	-	50
SKSEVO75120		120	40	90	80	6	8	13	TX40	-	50

SKR EVO SKS EVO

# SKR-E | SKS-E



## SCREW ANCHOR FOR CONCRETE CE1

- d<sub>1</sub>** external diameter of anchor
- L** anchor length
- t<sub>fix</sub>** maximum fastening thickness
- h<sub>1</sub>** minimum hole depth
- h<sub>nom</sub>** nominal anchoring depth
- h<sub>ef</sub>** effective anchor depth
- d<sub>0</sub>** hole diameter in the concrete support
- d<sub>f</sub>** maximum hole diameter in the element to be fastened
- SW** wrench size SKR-E
- d<sub>k</sub>** SKS-E head diameter
- T<sub>inst</sub>** tightening torque

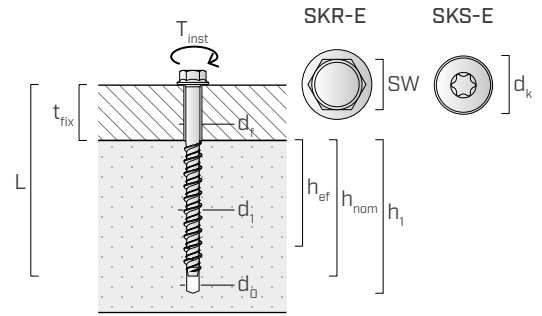

## CODES AND DIMENSIONS

### SKR-E hexagonal head with mock washer

CODE	d <sub>1</sub> [mm]	L [mm]	t <sub>fix</sub> [mm]	h <sub>1,min</sub> [mm]	h <sub>nom</sub> [mm]	h <sub>ef</sub> [mm]	d <sub>0</sub> [mm]	d <sub>f</sub> [mm]	SW [mm]	T <sub>inst</sub> [Nm]	pcs
SKR8100CE	8	100	40	75	60	48	6	9	10	20	50
SKR1080CE	10	80	10	85	70	56	8	12	13	50	50
SKR10100CE		100	30	85	70	56	8	12	13	50	25
SKR10120CE	12	120	50	85	70	56	8	12	13	50	25
SKR1290CE		90	10	100	80	64	10	14	15	80	25
SKR12110CE	12	110	30	100	80	64	10	14	15	80	25
SKR12150CE		150	70	100	80	64	10	14	15	80	25
SKR12210CE		210	130	100	80	64	10	14	15	80	20
SKR12250CE		250	170	100	80	64	10	14	15	80	15
SKR12290CE		290	210	100	80	64	10	14	15	80	15
SKR16130CE	16	130	20	140	110	85	14	18	21	160	10



SKR-E SKS-E

### SKS-E countersunk head

CODE	d <sub>1</sub> [mm]	L [mm]	t <sub>fix</sub> [mm]	h <sub>1,min</sub> [mm]	h <sub>nom</sub> [mm]	h <sub>ef</sub> [mm]	d <sub>0</sub> [mm]	d <sub>f</sub> [mm]	d <sub>k</sub> [mm]	TX	T <sub>inst</sub> [Nm]	pcs
SKS75100CE	8	100	40	75	60	48	6	9	16	TX30	20	50
SKS10100CE	10	100	30	85	70	56	8	12	20	TX40	50	50

## EKS

### HEXAGONAL HEAD BOLT Steel class 8.8 - zinc plated

#### CODES AND DIMENSIONS

d [mm]	CODE	thread	L [mm]	pcs
M20	EKS2040	●	40	25
	EKS2050	●	50	25
	EKS2060	●	60	25
	EKS2070	●●	70	25
	EKS2080	●●	80	25
	EKS20100	●●	100	25

DIN 933 (ISO 4017) - fully threaded (●)  
DIN 931 (ISO 4014) - partially threaded (●●)



d [mm]	CODE	thread	L [mm]	pcs
M24	EKS2440	●	40	25
	EKS2450	●	50	25
	EKS2460	●	60	25
	EKS2465	●	65	25
	EKS2470	●	70	25
	EKS2480	●●	80	25
	EKS2485	●●	85	25

# ABS



## HEAVY-DUTY EXPANSION ANCHOR WITH CLAMP CE1

$d_0$  anchor diameter = hole diameter in the concrete support  
 $d$  screw diameter  
 $L_t$  anchor length  
 $t_{fix}$  maximum fastening thickness  
 $h_1$  minimum hole depth  
 $h_{nom}$  nominal anchoring depth  
 $h_{ef}$  effective anchor depth  
 $d_f$  maximum hole diameter in the element to be fastened  
 $SW$  wrench size  
 $T_{inst}$  tightening torque

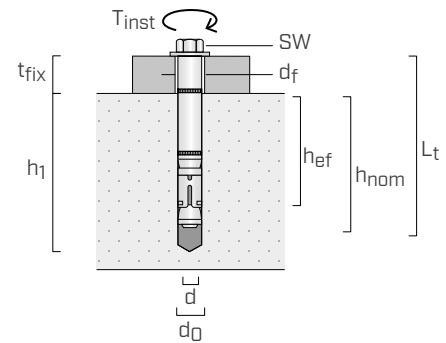

### CODES AND DIMENSIONS

CODE	$d_0$ [mm]	$L_t$ [mm]	$d_{screw}$ [mm]	$t_{fix}$ [mm]	$h_{1,min}$ [mm]	$h_{nom}$ [mm]	$h_{ef}$ [mm]	$d_f$ [mm]	SW [mm]	$T_{inst}$ [Nm]	pcs
ABS1070	10	70	M6	5	80	65	55	12	10	15	50
ABS10100		100	M6	35	80	65	55	12	10	15	50
ABS12100	12	100	M8	30	90	70	60	14	13	30	50
ABS12120		120	M8	50	90	70	60	14	13	30	25
ABS16120	16	120	M10	40	100	80	70	18	17	50	25
ABS16140		140	M10	60	100	80	70	18	17	50	20

# AB1



## HEAVY DUTY EXPANSION ANCHOR CE1

$d$  anchor diameter  
 $d_0$  hole diameter in the concrete support  
 $L_t$  anchor length  
 $t_{fix}$  maximum fastening thickness  
 $h_1$  minimum hole depth  
 $h_{nom}$  nominal anchoring depth  
 $h_{ef}$  effective anchor depth  
 $d_f$  maximum hole diameter in the element to be fastened  
 $SW$  wrench size  
 $T_{inst}$  tightening torque

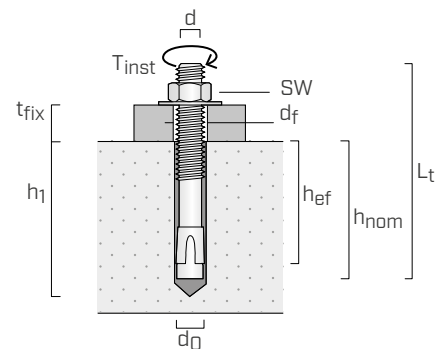

### CODES AND DIMENSIONS

CODE	$d = d_0$ [mm]	$L_t$ [mm]	$t_{fix}$ [mm]	$h_{1,min}$ [mm]	$h_{nom}$ [mm]	$h_{ef}$ [mm]	$d_f$ [mm]	SW [mm]	$T_{inst}$ [Nm]	pcs
AB1875	M8	75	9	60	55	48	9	13	15	100
AB1895	M8	95	29	60	55	48	9	13	15	50
AB18115	M8	115	49	60	55	48	9	13	15	50
AB110115	M10	115	35	75	68	60	12	17	40	25
AB110135	M10	135	55	75	68	60	12	17	40	25
AB112100	M12	100	4	85	80	70	14	19	60	25
AB112120	M12	120	24	85	80	70	14	19	60	25
AB112150	M12	150	54	85	80	70	14	19	60	25
AB112180	M12	180	84	85	80	70	14	19	60	25
AB116145	M16	145	28	105	97	85	18	24	100	10



# AB1 A4



## CE1 STAINLESS STEEL HEAVY-DUTY EXPANSION ANCHOR

- d** anchor diameter
- d<sub>0</sub>** hole diameter in the concrete support
- L<sub>t</sub>** anchor length
- t<sub>fix</sub>** maximum fastening thickness
- h<sub>1</sub>** minimum hole depth
- h<sub>nom</sub>** nominal anchoring depth
- h<sub>ef</sub>** effective anchor depth
- d<sub>f</sub>** maximum hole diameter in the element to be fastened
- SW** wrench size
- T<sub>inst</sub>** tightening torque

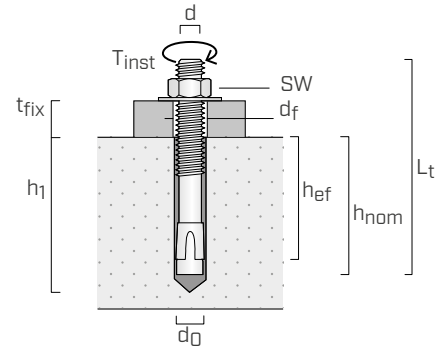

### CODES AND DIMENSIONS

CODE	d = d <sub>0</sub> [mm]	L <sub>t</sub> [mm]	t <sub>fix</sub> [mm]	h <sub>1,min</sub> [mm]	h <sub>nom</sub> [mm]	h <sub>ef</sub> [mm]	d <sub>f</sub> [mm]	SW [mm]	T <sub>inst</sub> [Nm]	pcs
AB1892A4	M8	92	30	60	50	45	9	13	20	50
AB18112A4		112	50	60	50	45	9	13	20	50
AB11092A4	M10	92	10	75	68	60	12	17	35	50
AB110132A4		132	50	75	68	60	12	17	35	25
AB112118A4	M12	118	20	90	81	70	14	19	70	20
AB116138A4	M16	138	20	110	96	85	18	24	120	10

# AB7



## HEAVY DUTY EXPANSION ANCHOR CE7

- d** anchor diameter
- d<sub>0</sub>** hole diameter in the concrete support
- L<sub>t</sub>** anchor length
- t<sub>fix</sub>** maximum fastening thickness
- h<sub>1</sub>** minimum hole depth
- h<sub>nom</sub>** nominal anchoring depth
- h<sub>ef</sub>** effective anchor depth
- d<sub>f</sub>** maximum hole diameter in the element to be fastened
- SW** wrench size
- T<sub>inst</sub>** tightening torque

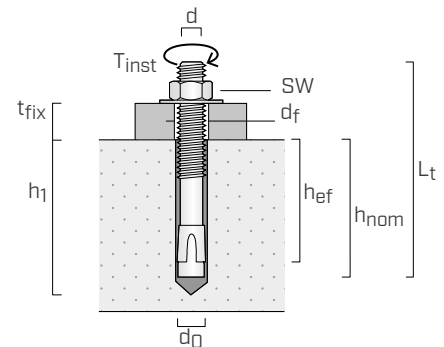

### CODES AND DIMENSIONS

#### AB7 STANDARD washer ISO 7089

CODE	d = d <sub>0</sub> [mm]	L <sub>t</sub> [mm]	t <sub>fix</sub> [mm]	h <sub>1,min</sub> [mm]	h <sub>nom</sub> [mm]	h <sub>ef</sub> [mm]	d <sub>f</sub> [mm]	SW [mm]	T <sub>inst</sub> [Nm]	pcs
AB71075	M10	75	10	65	55	50	12	17	35	50
AB712100	M12	100	18	80	70	60	14	19	55	50
AB712120		120	38	80	70	60	14	19	55	20
AB716145	M16	145	30	110	100	85	18	24	100	15
AB716220		220	105	110	100	85	18	24	100	10
AB720170	M20	170	35	125	115	100	22	30	150	5

#### AB7 EXTRALONG large size washer ISO 7093

CODE	d = d <sub>0</sub> [mm]	L <sub>t</sub> [mm]	t <sub>fix</sub> [mm]	h <sub>1,min</sub> [mm]	h <sub>nom</sub> [mm]	h <sub>ef</sub> [mm]	d <sub>f</sub> [mm]	SW [mm]	T <sub>inst</sub> [Nm]	pcs
AB716300	M16	300	185	110	100	85	18	24	100	5
AB716400		400	245	110	100	85	18	24	100	5

# VIN-FIX

## VINYL ESTER CHEMICAL ANCHOR WITHOUT STYRENE



### CODES AND DIMENSIONS

CODE	format	pcs
	[mL]	
FIX300	300	12
FIX420	420	12

Expiry from date of manufacturing: 12 months for 300 mL, 18 months for 420 mL.  
Storage temperature between +5 and +25° C.



# VIN-FIX PRO

## VINYL ESTER CHEMICAL ANCHOR WITHOUT STYRENE



### CODES AND DIMENSIONS

CODE	format	pcs
	[mL]	
VIN300	300	12
VIN410	410	12

Expiry from date of manufacturing: 12 months for 300 mL, 18 months for 410 mL.  
Storage temperature between +5 and +25° C.



# HYB-FIX

## HIGH-PERFORMANCE HYBRID CHEMICAL ANCHOR



### CODES AND DIMENSIONS

CODE	format	pcs
	[mL]	
HYB280	280	12
HYB420	420	12

Expiry from date of manufacturing: 18 months.  
Storage temperature between +5 and +25° C.



# EPO-FIX PLUS

## HIGH-PERFORMANCE EPOXY CHEMICAL ANCHOR



### CODES AND DIMENSIONS

CODE	format [mL]	pcs
EPO385	385	12

Expiry from date of manufacturing: 24 months.  
Storage temperature between +5 and +25° C.



# INA

## 5.8 STEEL CLASS THREADED ROD FOR CHEMICAL ANCHORS

### CODES AND DIMENSIONS

CODE	d [mm]	L <sub>t</sub> [mm]	d <sub>0</sub> [mm]	d <sub>f</sub> [mm]	pcs
INA8110	M8	110	10	≤ 9	10
INA10110	M10	110	12	≤ 12	10
INA10130		130	12	≤ 13	10
INA12130	M12	130	14	≤ 14	10
INA12180		180	14	≤ 15	10
INA16160	M16	160	18	≤ 18	10
INA16190		190	18	≤ 18	10
INA16230		230	18	≤ 18	10
INA20240	M20	240	24	≤ 22	10
INA24270	M24	270	28	≤ 26	10
INA27400	M27	400	32	≤ 30	10

d<sub>0</sub> = hole diameter in the support / d<sub>f</sub> = hole diameter in the element to be fastened



# IHP - IHM

## BUSHINGS FOR PERFORATED MATERIALS

### IHP - PLASTIC MESH

CODE	d <sub>0</sub> [mm]	L [mm]	rod [mm]	pcs
IHP1685	16	85	M10 (M8)	10
IHP16130	16	130	M10 (M8)	10
IHP2085	20	85	M12/M16	10

### IHM - METAL NET

CODE	d <sub>0</sub> [mm]	L [mm]	rod [mm]	pcs
IHM121000	12	1000	M8	50
IHM161000	16	1000	M8/M10	50
IHM221000	22	1000	M12/M16	25



## ULS AI 9021

### WASHER

CODE	rod	d <sub>INT</sub> [mm]	d <sub>EXT</sub> [mm]	s [mm]	pcs
AI90218	M8	8,4	24	2	500
AI902110	M10	10,5	30	2,5	500
AI902112	M12	13	37	3	200
AI902116	M16	17	50	3	100
AI902120	M20	22	60	4	50

\* ISO 7093 differs from DIN 9021 in the surface hardness.

A2  
AISI 304

Stainless steel A2 | AISI 304  
DIN 9021 (ISO 7093\*)

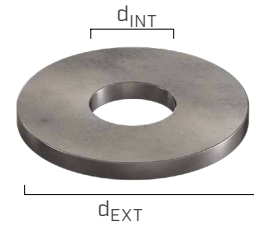

## MUT AI 934

### HEXAGONAL NUT

CODE	rod	h [mm]	SW [mm]	pcs
AI9348	M8	6,5	13	500
AI93410	M10	8	16	200
AI93412	M12	10	18	200
AI93416	M16	13	24	100
AI93420	M20	16	30	50

\* ISO 4032 differs from DIN 934 in diameters M10 and M12 for parameters h and SW.

A2  
AISI 304

Stainless steel A2 | AISI 304  
DIN 934 (ISO 4032\*)

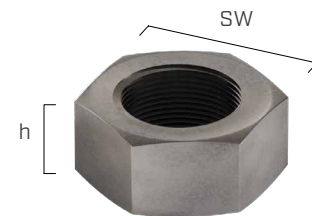

## MUT AI 985

### SELF-LOCKING NUT

CODE	rod	h [mm]	SW [mm]	pcs
AI9858	M8	8	13	500
AI98510	M10	10	17	200
AI98512	M12	12	19	200
AI98516	M16	16	24	100

\* ISO 10511 differs from DIN 985 in diameters M10 and M12 for parameters h and SW.

A2  
AISI 304

Stainless steel A2 | AISI 304  
DIN 985 (ISO 10511\*)

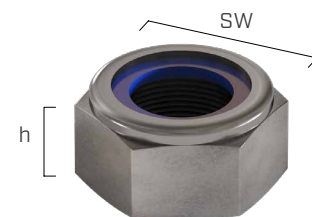

## MUT AI 1587

### BLIND NUT

CODE	rod	h [mm]	SW [mm]	pcs
AI158710	M10	18	17	100
AI158712	M12	22	19	100
AI158716	M16	28	24	50
AI158720	M20	34	30	25

Single-piece turned nut.

A2  
AISI 304

Stainless steel A2 | AISI 304  
DIN 1587

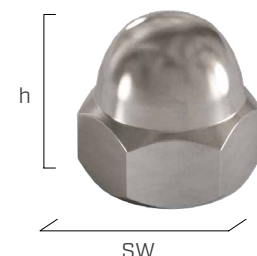

## MGS 1000

### THREADED ROD

CODE	rod	L [mm]	pcs
MGS10008	M8	1000	10
MGS100010	M10	1000	10
MGS100012	M12	1000	10
MGS100014	M14	1000	10
MGS100016	M16	1000	10
MGS100018	M18	1000	10
MGS100020	M20	1000	10
MGS100022	M22	1000	10
MGS100024	M24	1000	10
MGS100027	M27	1000	10
MGS100030	M30	1000	10

Steel class 4.8 - zinc plated  
DIN 975

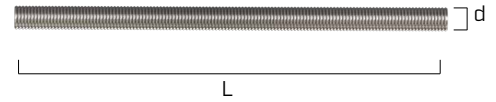

## MGS 1000

### THREADED ROD

CODE	rod	L [mm]	pcs
MGS10888	M8	1000	1
MGS11088	M10	1000	1
MGS11288	M12	1000	1
MGS11488	M14	1000	1
MGS11688	M16	1000	1
MGS11888	M18	1000	1
MGS12088	M20	1000	1
MGS12488	M24	1000	1
MGS12788	M27	1000	1

Steel class 8.8 - zinc plated  
DIN 975

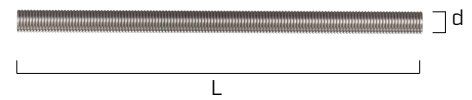

## MUT 934

### HEXAGONAL NUT

CODE	rod	h [mm]	SW [mm]	pcs
MUT9348	M8	6,5	13	400
MUT93410	M10	8	17	500
MUT93412	M12	10	19	500
MUT93414	M14	11	22	200
MUT93416	M16	13	24	200
MUT93418	M18	15	27	100
MUT93420	M20	16	30	100
MUT93422	M22	18	32	50
MUT93424	M24	19	36	50
MUT93427	M27	22	41	25
MUT93430	M30	24	46	25

Steel class 8 - zinc plated  
DIN 934 (ISO 4032\*)

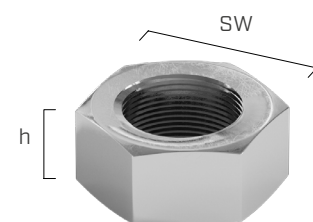

\* ISO 4032 differs from DIN 934 for parameters h and SW and diameters M10, M12, M14 and M22.

## ULS 9021

### WASHER

CODE	rod	d <sub>INT</sub> [mm]	d <sub>EXT</sub> [mm]	s [mm]	pcs
ULS8242	M8	8,4	24	2	200
ULS10302	M10	10,5	30	2,5	200
ULS13373	M12	13	37	3	100
ULS15443	M14	15	44	3	100
ULS17503	M16	17	50	3	100
ULS20564	M18	20	56	4	50
ULS22604	M20	22	60	4	50

\* ISO 7093 differs from DIN 9021 in the surface hardness.

S235 steel - zinc plated  
DIN 9021 (ISO 7093\*)

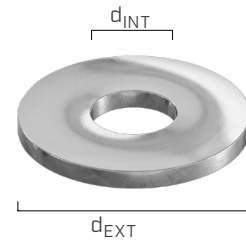

## ULS 440

### WASHER

CODE	rod	d <sub>INT</sub> [mm]	d <sub>EXT</sub> [mm]	s [mm]	pcs
ULS11343	M10	11	34	3	200
ULS13444	M12	13,5	44	4	200
ULS17565	M16	17,5	56	5	50
ULS22726	M20	22	72	6	50
ULS24806	M22	24	80	6	25

\* ISO 7094 differs from DIN 440 R in the surface hardness.

S235 steel - zinc plated  
DIN 440 R (ISO 7094\*)

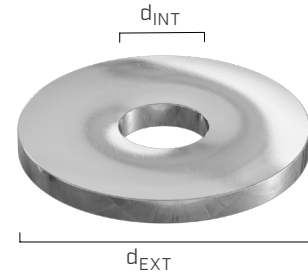

## ULS 1052

### WASHER

CODE	rod	d <sub>INT</sub> [mm]	d <sub>EXT</sub> [mm]	s [mm]	pcs
ULS14586	M12	14	58	6	50
ULS18686	M16	18	68	6	50
ULS22808	M20	22	80	8	25
ULS25928	M22	25	92	8	20
ULS271058	M24	27	105	8	20

S235 steel - zinc plated  
DIN 1052

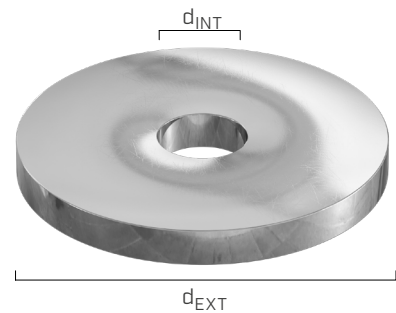

## ULS 125

### WASHER

CODE	rod	d <sub>INT</sub> [mm]	d <sub>EXT</sub> [mm]	s [mm]	pcs
ULS81616	M8	8,4	16	1,6	1000
ULS10202	M10	10,5	20	2	500
ULS13242	M12	13	24	2,5	500
ULS17303	M16	17	30	3	250
ULS21373	M20	21	37	3	250
ULS25444	M24	25	44	4	200
ULS28504	M27	28	50	4	100
ULS31564	M30	31	56	4	20

\* ISO 7089 differs from DIN 125 A in the surface hardness.

S235 steel - zinc plated  
DIN 125 A (ISO 7089\*)

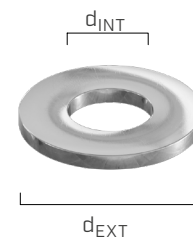

# THE MINIMUM NECESSARY TO WORK AT MAXIMUM EFFICIENCY

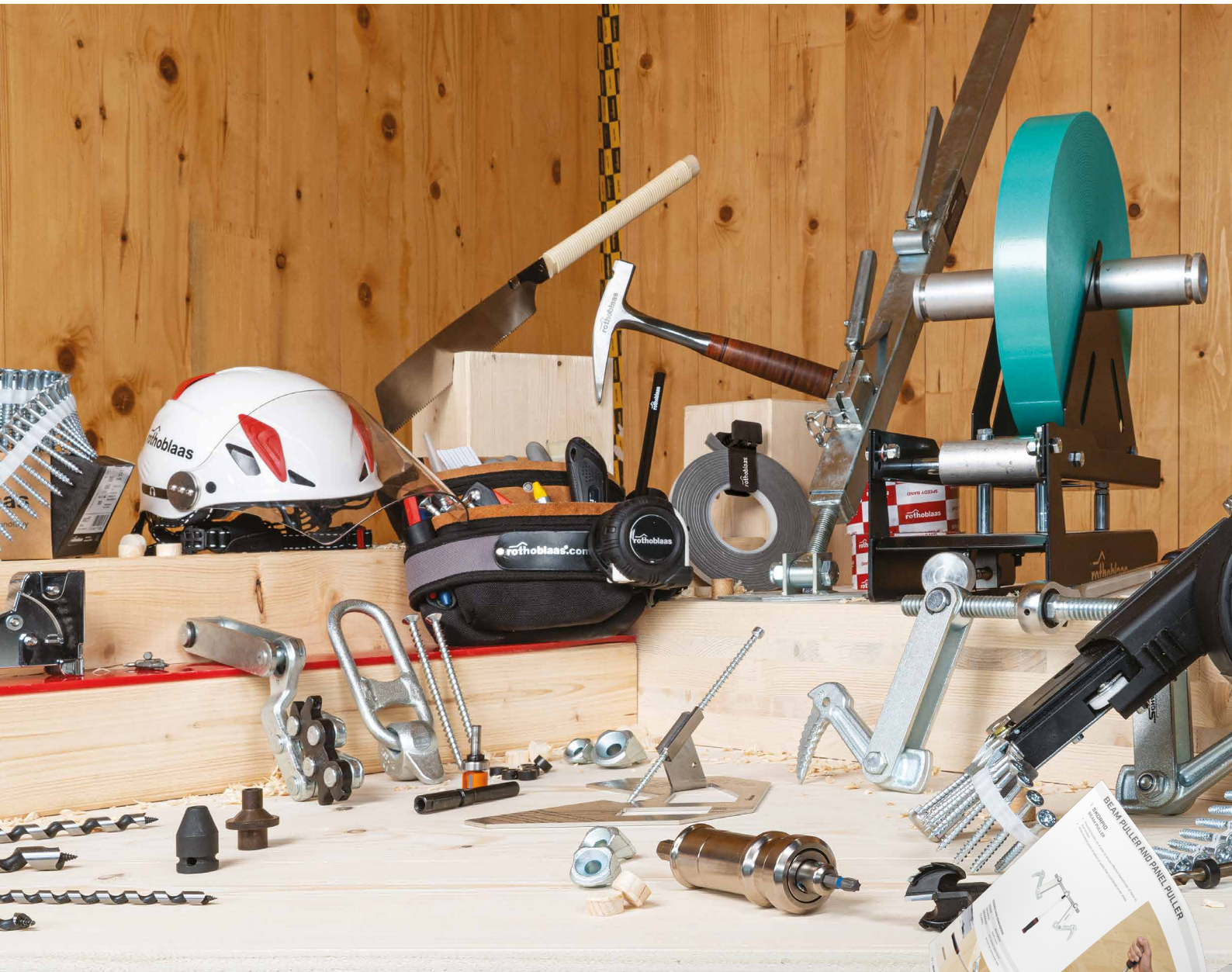

Discover the carpenters' favourite working tools! We introduce them to you in the "Tools for timber construction" catalogue: a selection including carpentry tools, screwdrivers, machines and nailguns, transport and lifting systems, drill bits, cutters and wood repair solutions, as well as a wide range of specific accessories.

**TRY THEM, YOU WILL NEVER LEAVE THEM BEHIND AGAIN!**

Download the catalogue and find out how to work at your best!



[www.rothoblaas.com](http://www.rothoblaas.com)



**rothoblaas**

Solutions for Building Technology

# CRICKET

## 8 SIZES RATCHETING WRENCH

- Ratchet spanner with through hole and 8 bushings of varying sizes
- 4 ring spanners in a single tool

### CODES AND CHARACTERISTICS

CODE	dimensions / thread [SW / M]	length [mm]	pcs
CRICKET	10 / M6 - 13 / M8	340	1
	14 / (M8) - 17 / M10		
	19 / M12 - 22 / M14		
	24 / M16 - 27 / M18		

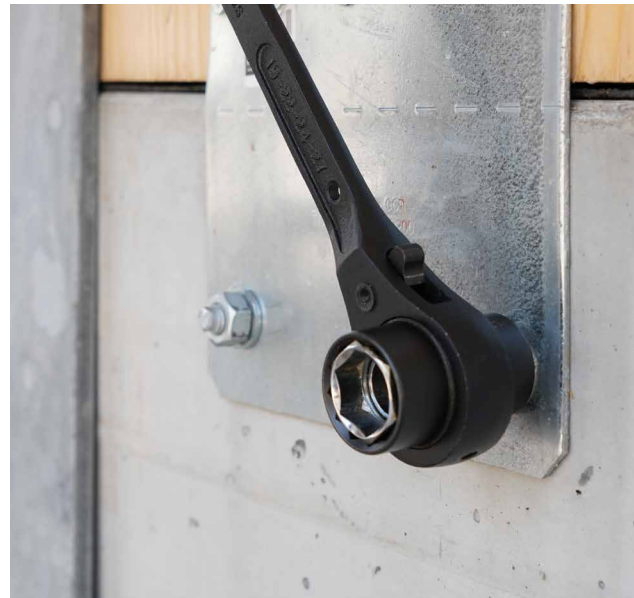

# BEAR

## TORQUE WRENCH

- Precise tightening torque control
- Wide adjustment range

### CODES AND CHARACTERISTICS

CODE	dimensions [mm]	weight [g]	tightening torque [Nm]	pcs
BEAR	395 x 60 x 60	1075	10 - 50	1
BEAR2	535 x 60 x 60	1457	40 - 200	1

With 1/2" square drive.



# FINCH

## PROFESSIONAL RIVETING MACHINE

- Light and manoeuvrable
- Ideal for large and structural rivets

### CODES AND CHARACTERISTICS

CODE	Ø rivets [mm]	weight [kg]	pcs
FINCH3064	3,0 - 4,0 - 4,8 - 6,4	1,4	1





# BIRD

## BATTERY-OPERATED RIVETING MACHINE

- Ergonomic and lightweight
- Excellent manoeuvrability even in tight spaces
- Equipped with two batteries with charger
- Up to 1400 rivets on one charge

### CODES AND CHARACTERISTICS

CODE	battery [Ah]	Ø rivets [mm]	weight [kg]	strength [N]	pcs
BIRD5277	2,0	5,2 - 6,4 - 7,7	2,15	12.000	1

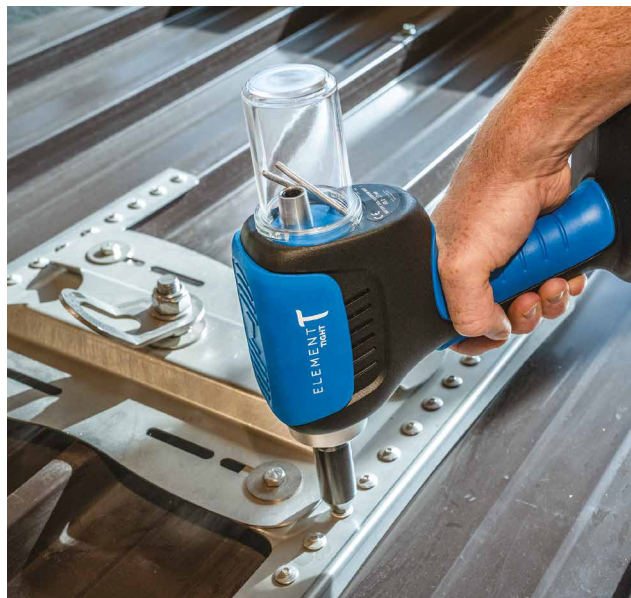

# ROPE CLAMP

## CABLE TENSIONER FOR ANCHOR LINE

- Used with the CABLE CLAMP, it makes it easier to lock the cable and with its lever it makes it possible to pre-tension the cable

### CODES AND CHARACTERISTICS

CODE	description	standard	material	load capacity [kg]	pcs
SPAN1	cable tensioner hoist	DIN EN 818-7	zinc-plated steel	250	1

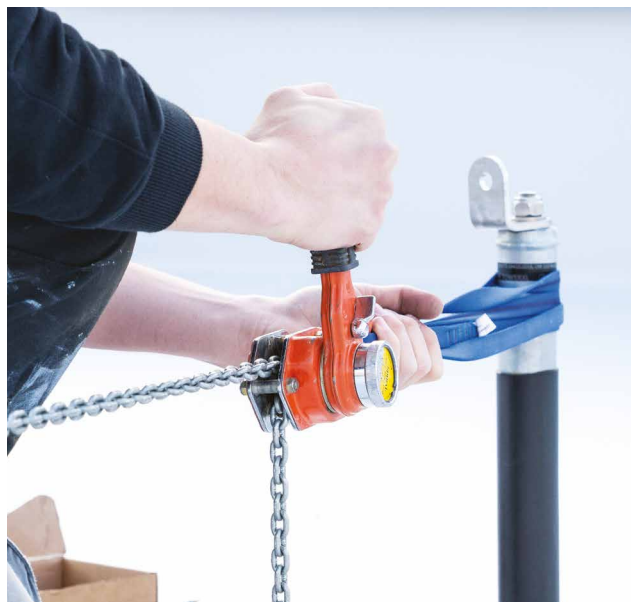

# CABLE CLAMP

## STEEL ROPE CLAMP

- Used in conjunction with the ROPE CLAMP, it facilitates cable clamping during pre-tensioning of the lifeline cable

### CODES AND CHARACTERISTICS

CODE	description	pcs
CABLECLAMP	clamp for steel cable Ø5-10 mm	1

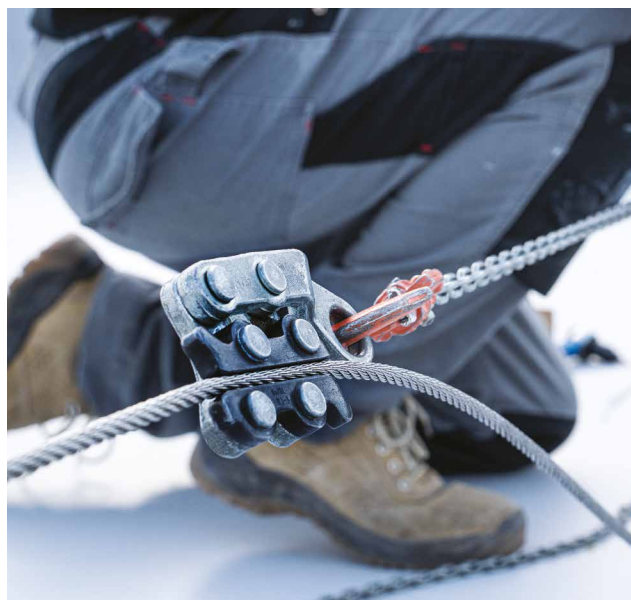

# CABCUT

## SHEARS

- For cutting steel cables up to Ø12 mm

### CODES AND CHARACTERISTICS

CODE	length [mm]	max. cable resistance Ø8 mm [kg/mm <sup>2</sup> ]	weight [kg]	pcs
CABCUT500	500	160	1,5	1



# A 10 M

## CORDLESS SCREWDRIVER 10,8 V

- 1/4" Spindle for direct tool mounting
- LED lights provide illumination over large areas

### CODES AND CHARACTERISTICS

CODE	description	no. of revolutions (moment) [min <sup>-1</sup> ] [Nm]	battery 22 Wh/43 Wh	weight [kg]	pcs
MA919901	MIDIMAX IN T-MAX	0-360 (34)/ 0-1400 (17)	1/1	0,8	1
MA919902*	MAXIMAX IN T-MAX		0/2	0,8	1

\* Includes quick-change driver bit holder.

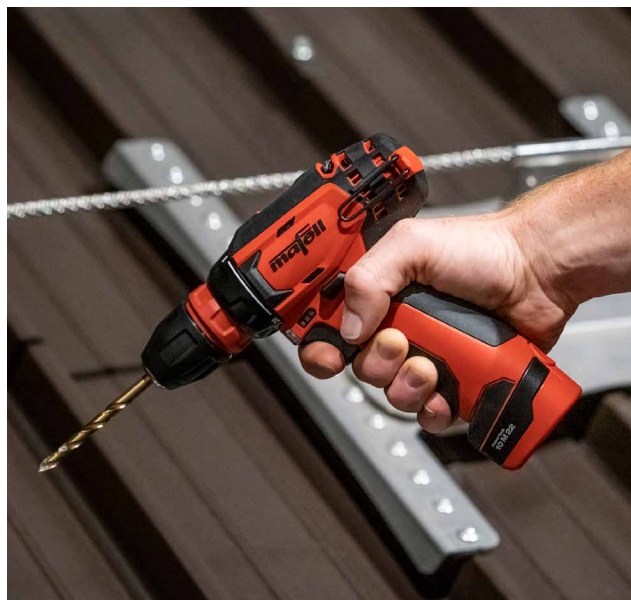

# ASB 18 M BL

## CORDLESS PERCUSSION DRILL

- Brushless motor ensures long life
- 1/4" drill chuck for direct insertion of accessories
- Effective LEDs for illuminating the work area

### CODES AND CHARACTERISTICS

CODE	description	no. of revolutions (moment) [min <sup>-1</sup> ] [Nm]	battery 72 Wh	weight [kg]	pcs
MA91A101*	MIDIMAX IN T-MAX	0-600 (90) / 0-2050 (44)	2	1,9	1

\* Includes quick-change driver bit holder.

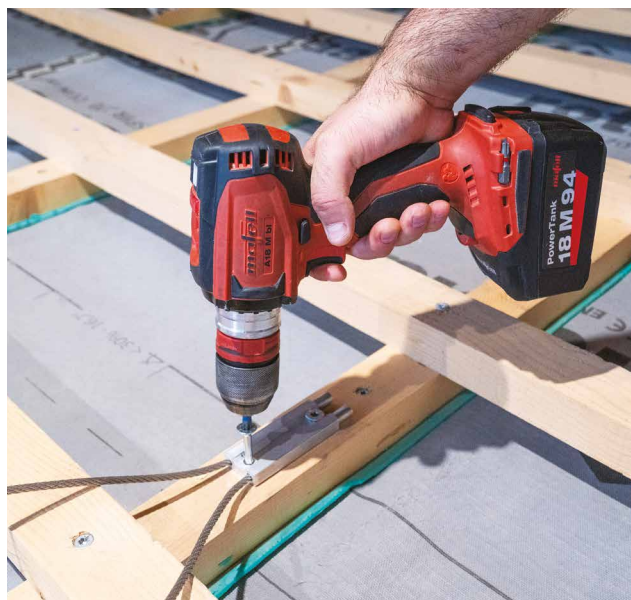

# SOCKET

## BUSHINGS AND BITS



### CODES AND CHARACTERISTICS

CODE	wrench size	machine housing	length [mm]	pcs
SOCKET10	10	1/2"	40	1
SOCKET12	12	1/2"	40	1
SOCKET13	13	1/2"	40	1
SOCKET15	15	1/2"	40	1
SOCKET16	16	1/2"	40	1
SOCKET17	17	1/2"	40	1
SOCKET18	18	1/2"	40	1
SOCKET19	19	1/2"	40	1
SOCKET22	22	1/2"	40	1
SOCKET24	24	1/2"	40	1
SOCKETL13	13	1/2"	80	1
SOCKETL19	19	1/2"	80	1
SOCKETBIT	bit holder 1/4"	1/2"	-	1
SOCKETHEX5	Hex 5	1/2"	60	1
HEX525	-	connector C 6.3 (1/4")	25	5

# SNAIL METAL

## HSS HIGH-SPEED STEEL TWIST DRILL BIT

- Super-rapid steel drill bits for drilling holes in metal structures

### CODES AND CHARACTERISTICS

CODE	Ø [mm]	TL [mm]	EL [mm]	pcs
F2430065	6,5	101	63	1
F2430080	8,0	117	75	1
F2430100	10,0	133	87	1
F2430120	12,0	151	101	1
F2430130	13,0	151	101	1
F2599216	16,0	250	200	1



# TORLIM

## TORQUE LIMITER



### CODES AND CHARACTERISTICS

CODE	description	pcs
TORLIM5	torque limiter 5 Nm	3

# TUCA

## RAPID FEED PIPE CUTTER 6-67 mm



### CODES AND CHARACTERISTICS

CODE	description	L [mm]	H [mm]	A [mm]	E <sub>max</sub> [mm]	pcs
TUCA	stainless steel pipe cutter	230	100	6-67	2,5	1

# FLY

## PROFESSIONAL GUN FOR 310 mL CARTRIDGES

- The FLY sealant gun is designed to be used with 310 mL soft cartridges
- Made of durable materials, it ensures easy processing



### CODES AND CHARACTERISTICS

CODE	description	pcs
FLY	for cartridges of 310 mL	1

# MAMMOTH

## SPECIAL GUN FOR 400 mL CARTRIDGES

- Specially developed to accommodate 400 mL cartridges
- Robust and durable, it allows precise application of resin



### CODES AND CHARACTERISTICS

CODE	description	pcs
MAM400	for cartridges of 400 mL	1

# MAMAUTO600

## BATTERY-OPERATED RESIN GUN

- 7.4V/1.3 Ah lithium battery
- Adjustable forward speed (1-6)
- Up to 30 x 310 mL cartridges or 20 x 600 mL soft cartridges per battery charge

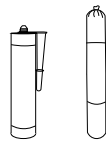

### CODES AND CHARACTERISTICS

CODE	description	pcs
MAMAUTO600	for 310 mL cartridges and soft cartridges up to 600 mL	1

# ESTRO

## 25 kN PORTABLE EXTRACTOMETER

- Detachable dual scale 25 kN digital pressure gauge
- Stroke up to 50 mm
- Complete package of accessories

### CODES AND CHARACTERISTICS

CODE	description	test capabilities [kN]	Ø testable [mm]	digital pressure gauge	pcs
ESTRO25	25 kN extractometer	25	4-20	-	1
ESTRO25D*	25 kN digital extractometer	25	4-20	●	1



\*Compatible with Bluetooth connected software app.

# DISTY

## LASER DISTANCE METER

- Measuring range 0.05 - 40 m
- Measuring accuracy 2 mm
- Rechargeable via USB-micro cable

### CODES

CODE	description	pcs
DISTY	laser distance meter	1



# SNAIL

## MEASURING TAPE

### CODES AND CHARACTERISTICS

CODE	size [m]	pcs
SNAIL5	5	1
SNAIL8	8	1

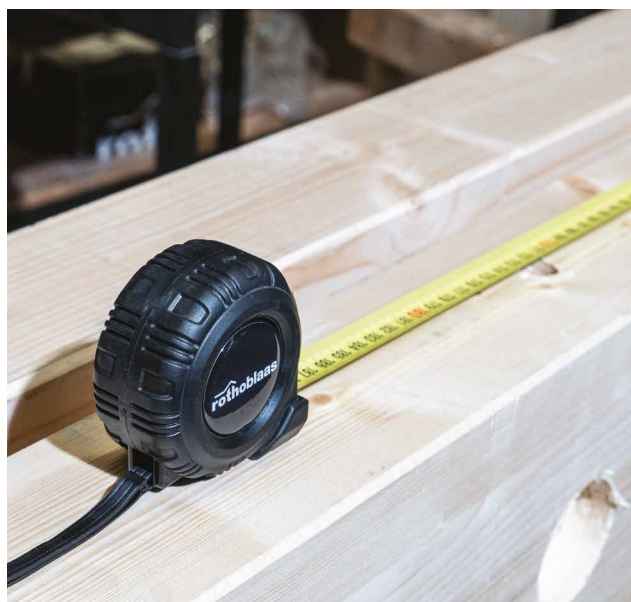

# MANTA

## TAPE WHEEL, STEEL

### CODES AND CHARACTERISTICS

CODE	size [m]	pcs
MNT25	25	1



# RBMET

## FOLDING RULER

### CODES

CODE	size [m]	pcs
RBMET	2	1



# SNAIL PULSE

## CARBIDE DRILL BIT IN HM WITH SDS DRILL CHUCK SHANK

### CODES AND CHARACTERISTICS

CODE	Ø tip [mm]	TL [mm]	pcs
DUHPV505	5	50	1
DUHPV510	5	100	1
DUHPV605	6	50	1
DUHPV610	6	100	1
DUHPV615	6	150	1
DUHPV810	8	100	1
DUHPV815	8	150	1
DUHPV820	8	200	1
DUHPV840	8	400	1
DUHPV1010	10	100	1
DUHPV1015	10	150	1
DUHPV1020	10	200	1
DUHPV1040	10	400	1
DUHPV1210	12	100	1
DUHPV1215	12	150	1
DUHPV1220	12	200	1
DUHPV1240	12	400	1
DUHPV1410	14	100	1
DUHPV1420	14	200	1
DUHPV1440	14	400	1
DUHPV1625	16	250	1
DUHPV1640	16	400	1
DUHPV1820	18	200	1
DUHPV1840	18	400	1
DUHPV2020	20	200	1
DUHPV2040	20	400	1
DUHPV2240	22	400	1
DUHPV2440	24	400	1
DUHPV2540	25	400	1
DUHPV2840	28	400	1
DUHPV3040	30	400	1



Rotho Blaas Srl does not guarantee the legal and/or design conformity of data and calculations, as Rotho Blass provides indicative tools such as technical-commercial service within the sales activity.

Rotho Blaas Srl follows a policy of continuous development of its products, thereby reserving the right to modify their characteristics, technical specifications and other documentation without notice.

The user or the designer are responsible to verify, at each use, the conformity of the data to the regulations in force and to the project. The ultimate responsibility for choosing the appropriate product for a specific application lies with the user/designer.

The values resulting from "experimental investigations" are based on the actual test results and valid only for the test conditions specified.

Rotho Blaas Srl does not guarantee and in no case can be held responsible for damages, losses and costs or other consequences, for any reason (warranty for defects, warranty for malfunction, product or legal responsibility, etc.) deriving from the use or inability to use the products for any purpose; from non-conforming use of the product; Rotho Blaas Srl is not liable in any way for any errors in printing and/or typing. In the event of differences between the contents of the catalogue versions in the various languages, the Italian text is binding and takes precedence with respect to the translations. The latest version of the data sheets available can be found on the Rotho Blaas website.

Pictures are partially completed with accessories not included. Images are for illustration purposes only. The use of third party logos and trademarks in this catalogue is subject to the terms and conditions set out in the general conditions of purchase, unless otherwise agreed with the supplier. Packaged quantities may vary.

This catalogue is private property of Rotho Blaas Srl and may not be copied, reproduced or published, totally or in part, without prior written consent. All violations will be prosecuted according to law.

The general purchase and sale conditions of Rotho Blaas Srl are available on the website [www.rothoblaas.com](http://www.rothoblaas.com).